

1:	8.4	↗
2:	8.7	↑
3:	10.5	↘
4:	10.4	↙
<b>Serie</b>	<b>36.0</b>	
<b>Total</b>	<b>0.0</b>	

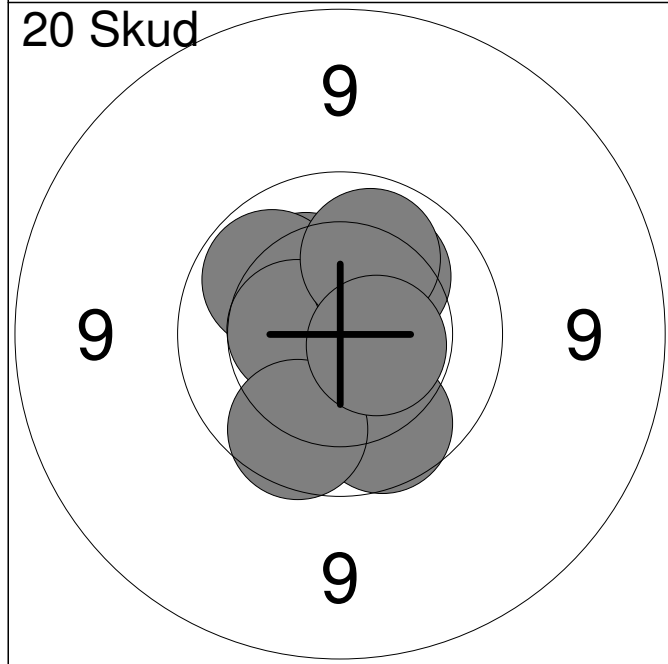

1:	10.8x	↗
2:	10.7x	↗
3:	10.3	↗
4:	9.9	↘
5:	10.0	↗
6:	10.5	←
7:	10.2	↗
8:	9.9	↘
9:	10.1	↗
10:	10.5x	↘
<b>Serie</b>	<b>98.0</b>	
<b>Total</b>	<b>98.0</b>	

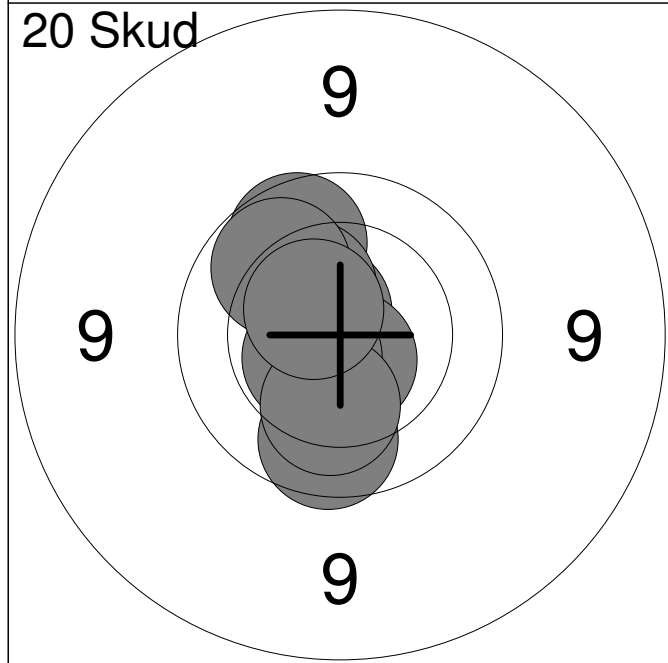

11:	9.9	↘
12:	10.6x	↙
13:	9.9	↗
14:	10.6x	↗
15:	10.7x	↘
16:	10.3	↗
17:	10.6x	↙
18:	10.2	↘
19:	10.0	↗
20:	10.6x	↗
<b>Serie</b>	<b>98.0</b>	
<b>Total</b>	<b>196.0</b>	

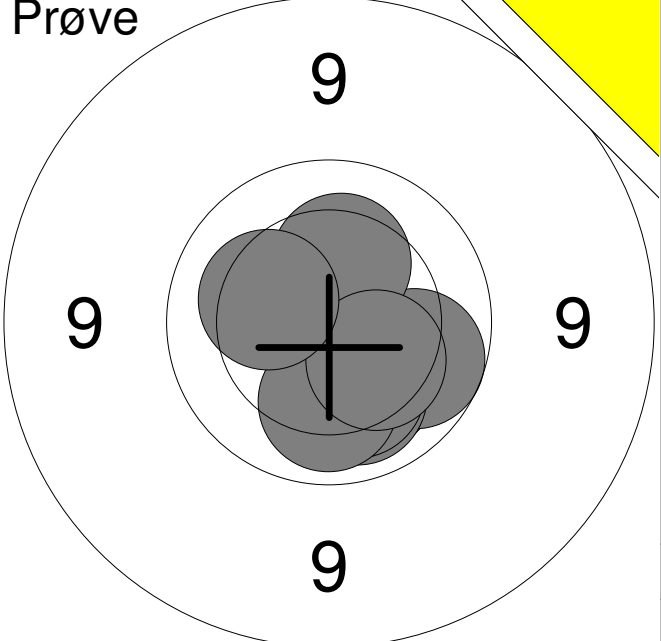
<p><b>Prøve</b></p> 	<table style="width:100%; border-collapse: collapse;"> <tr><td style="width:10%;">1:</td><td style="width:15%;">10.2</td><td style="width:10%; text-align: right;">↘</td></tr> <tr><td>2:</td><td>10.0</td><td style="text-align: right;">→</td></tr> <tr><td>3:</td><td>10.1</td><td style="text-align: right;">↘</td></tr> <tr><td>4:</td><td>10.3</td><td style="text-align: right;">↑</td></tr> <tr><td>5:</td><td>10.2</td><td style="text-align: right;">↘</td></tr> <tr><td>6:</td><td>10.1</td><td style="text-align: right;">↘</td></tr> <tr><td>7:</td><td>10.3</td><td style="text-align: right;">↘</td></tr> <tr><td>8:</td><td>10.3</td><td style="text-align: right;">↑</td></tr> <tr><td colspan="2"><b>Serie</b></td><td style="text-align: right;"><b>80.0</b></td></tr> <tr><td colspan="2"><b>Total</b></td><td style="text-align: right;"><b>0.0</b></td></tr> </table>	1:	10.2	↘	2:	10.0	→	3:	10.1	↘	4:	10.3	↑	5:	10.2	↘	6:	10.1	↘	7:	10.3	↘	8:	10.3	↑	<b>Serie</b>		<b>80.0</b>	<b>Total</b>		<b>0.0</b>
1:	10.2	↘																													
2:	10.0	→																													
3:	10.1	↘																													
4:	10.3	↑																													
5:	10.2	↘																													
6:	10.1	↘																													
7:	10.3	↘																													
8:	10.3	↑																													
<b>Serie</b>		<b>80.0</b>																													
<b>Total</b>		<b>0.0</b>																													

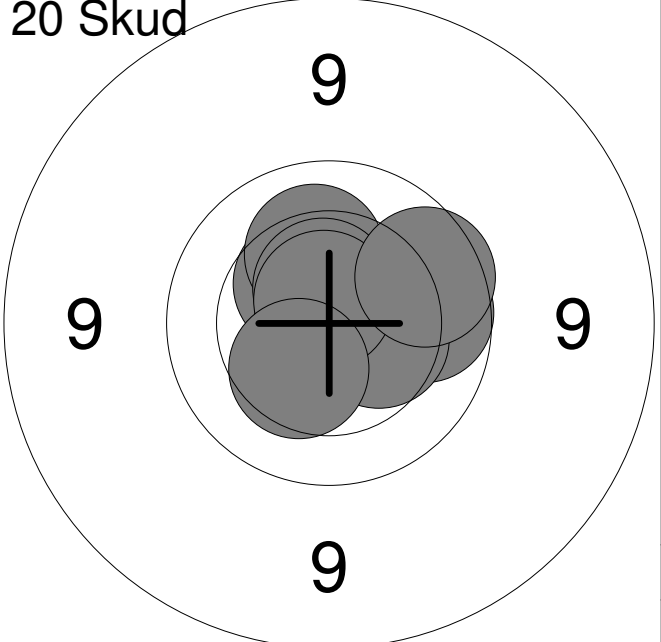
<p><b>20 Skud</b></p> 	<table style="width:100%; border-collapse: collapse;"> <tr><td style="width:10%;">1:</td><td style="width:15%;">10.5x</td><td style="width:10%; text-align: right;">↑</td></tr> <tr><td>2:</td><td>10.4</td><td style="text-align: right;">↗</td></tr> <tr><td>3:</td><td>9.9</td><td style="text-align: right;">→</td></tr> <tr><td>4:</td><td>10.2</td><td style="text-align: right;">↑</td></tr> <tr><td>5:</td><td>10.6x</td><td style="text-align: right;">↑</td></tr> <tr><td>6:</td><td>10.9x</td><td style="text-align: right;">↖</td></tr> <tr><td>7:</td><td>10.4</td><td style="text-align: right;">→</td></tr> <tr><td>8:</td><td>10.7x</td><td style="text-align: right;">↑</td></tr> <tr><td>9:</td><td>10.4</td><td style="text-align: right;">↘</td></tr> <tr><td>10:</td><td>9.9</td><td style="text-align: right;">↗</td></tr> <tr><td colspan="2"><b>Serie</b></td><td style="text-align: right;"><b>98.0</b></td></tr> <tr><td colspan="2"><b>Total</b></td><td style="text-align: right;"><b>98.0</b></td></tr> </table>	1:	10.5x	↑	2:	10.4	↗	3:	9.9	→	4:	10.2	↑	5:	10.6x	↑	6:	10.9x	↖	7:	10.4	→	8:	10.7x	↑	9:	10.4	↘	10:	9.9	↗	<b>Serie</b>		<b>98.0</b>	<b>Total</b>		<b>98.0</b>
1:	10.5x	↑																																			
2:	10.4	↗																																			
3:	9.9	→																																			
4:	10.2	↑																																			
5:	10.6x	↑																																			
6:	10.9x	↖																																			
7:	10.4	→																																			
8:	10.7x	↑																																			
9:	10.4	↘																																			
10:	9.9	↗																																			
<b>Serie</b>		<b>98.0</b>																																			
<b>Total</b>		<b>98.0</b>																																			

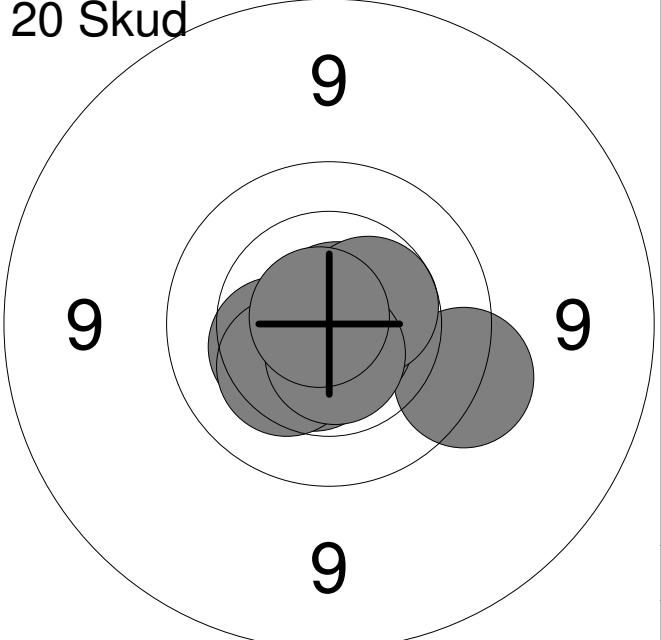
<p><b>20 Skud</b></p> 	<table style="width:100%; border-collapse: collapse;"> <tr><td style="width:10%;">11:</td><td style="width:15%;">10.3</td><td style="width:10%; text-align: right;">↖</td></tr> <tr><td>12:</td><td>10.7x</td><td style="text-align: right;">↘</td></tr> <tr><td>13:</td><td>10.5x</td><td style="text-align: right;">↘</td></tr> <tr><td>14:</td><td>9.6</td><td style="text-align: right;">→</td></tr> <tr><td>15:</td><td>10.7x</td><td style="text-align: right;">↘</td></tr> <tr><td>16:</td><td>10.3</td><td style="text-align: right;">↖</td></tr> <tr><td>17:</td><td>10.8x</td><td style="text-align: right;">↗</td></tr> <tr><td>18:</td><td>10.5</td><td style="text-align: right;">→</td></tr> <tr><td>19:</td><td>10.6x</td><td style="text-align: right;">↘</td></tr> <tr><td>20:</td><td>10.8x</td><td style="text-align: right;">↗</td></tr> <tr><td colspan="2"><b>Serie</b></td><td style="text-align: right;"><b>99.0</b></td></tr> <tr><td colspan="2"><b>Total</b></td><td style="text-align: right;"><b>197.0</b></td></tr> </table>	11:	10.3	↖	12:	10.7x	↘	13:	10.5x	↘	14:	9.6	→	15:	10.7x	↘	16:	10.3	↖	17:	10.8x	↗	18:	10.5	→	19:	10.6x	↘	20:	10.8x	↗	<b>Serie</b>		<b>99.0</b>	<b>Total</b>		<b>197.0</b>
11:	10.3	↖																																			
12:	10.7x	↘																																			
13:	10.5x	↘																																			
14:	9.6	→																																			
15:	10.7x	↘																																			
16:	10.3	↖																																			
17:	10.8x	↗																																			
18:	10.5	→																																			
19:	10.6x	↘																																			
20:	10.8x	↗																																			
<b>Serie</b>		<b>99.0</b>																																			
<b>Total</b>		<b>197.0</b>																																			

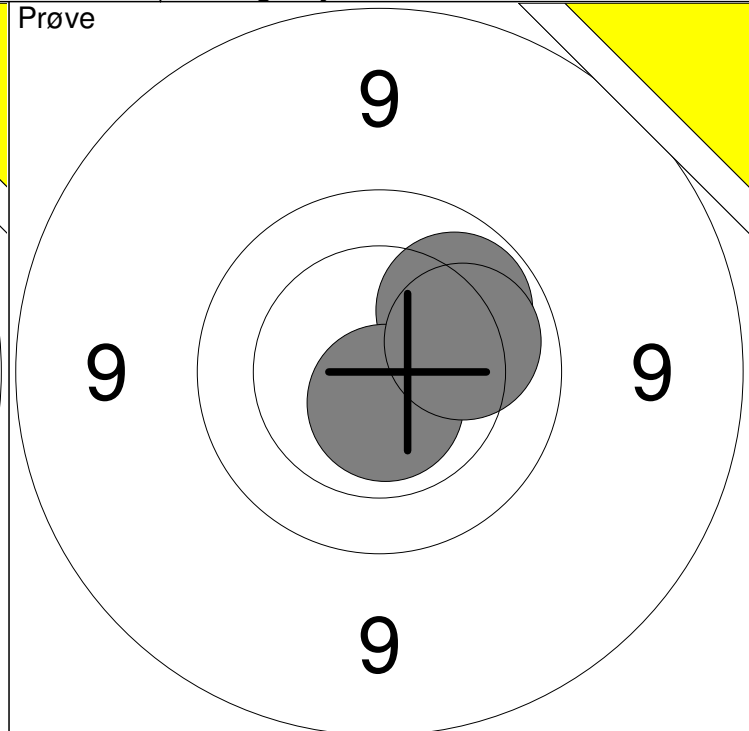
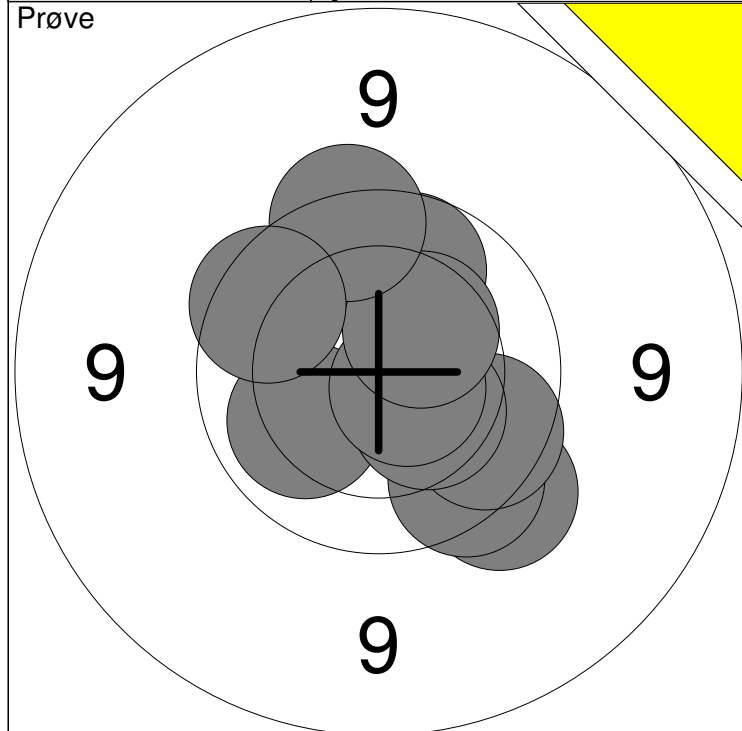

1: 9.6 ↘	6: 10.6x ↘	Serie	94
2: 9.8 ↘	7: 9.9 ↗		
3: 9.8 ↘	8: 10.4 ↗	Total	0
4: 10.1 ↙	9: 9.7 ↗		
5: 10.3 ↘	10: 9.8 ↙		

11: 10.0 ↗	Serie	30
12: 10.6x ↘		
13: 10.1 →	Total	0

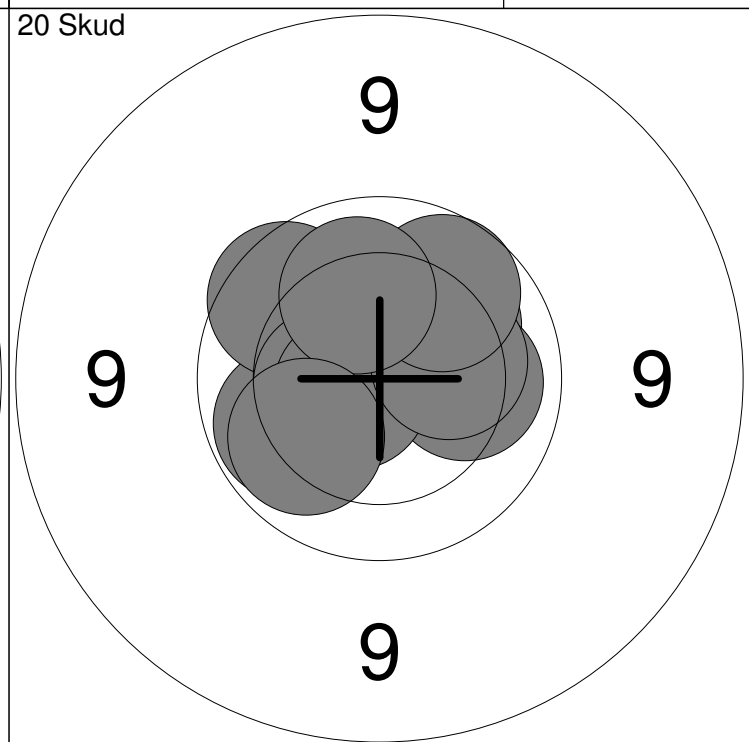
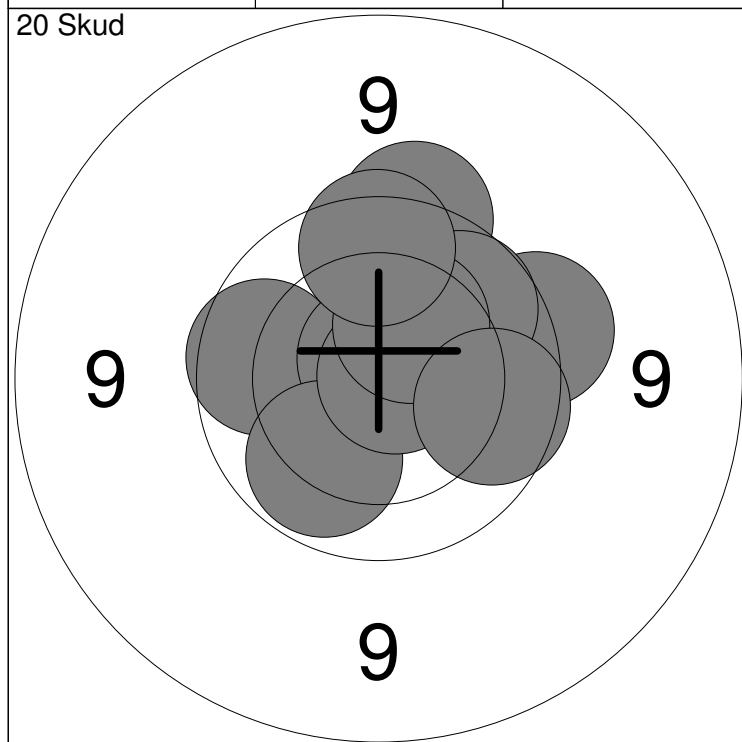

1: 9.9 ←	6: 9.9 ↗	Serie	94
2: 10.8x ↗	7: 10.8x →		
3: 9.6 ↗	8: 10.3 ↗	Total	94
4: 9.6 →	9: 9.8 ↗		
5: 10.0 ↘	10: 9.9 →		

11: 10.1 ↗	16: 10.7x ←	Serie	98
12: 10.0 ←	17: 10.3 →		
13: 9.8 ↙	18: 9.9 ↗	Total	192
14: 10.5 ←	19: 10.1 ↗		
15: 10.1 →	20: 10.0 ↘		

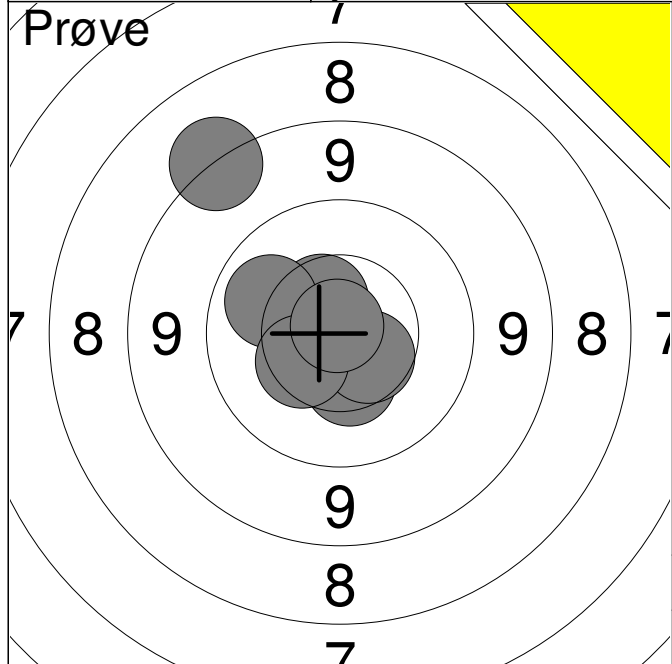

1:	8.4	↗
2:	10.5	↗
3:	10.1	↗
4:	10.4	↘
5:	10.9x	←
6:	10.5	↘
7:	10.4	↖
8:	10.9x	↗
<b>Serie</b>		<b>78.0</b>
<b>Total</b>		<b>0.0</b>

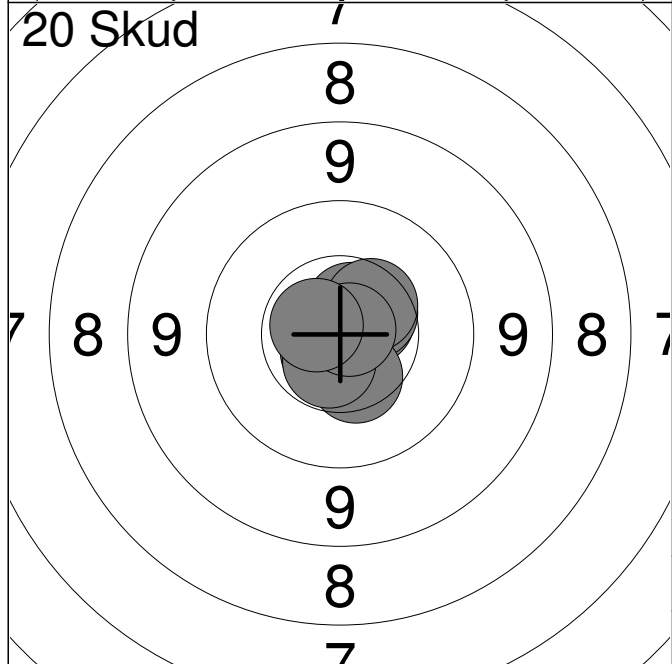

1:	10.6	↗
2:	10.7x	↘
3:	10.5	↗
4:	10.6x	↗
5:	10.7x	↘
6:	10.5	↗
7:	10.4	↘
8:	10.6x	↘
9:	10.8x	↗
10:	10.7x	↖
<b>Serie</b>		<b>100.0</b>
<b>Total</b>		<b>100.0</b>

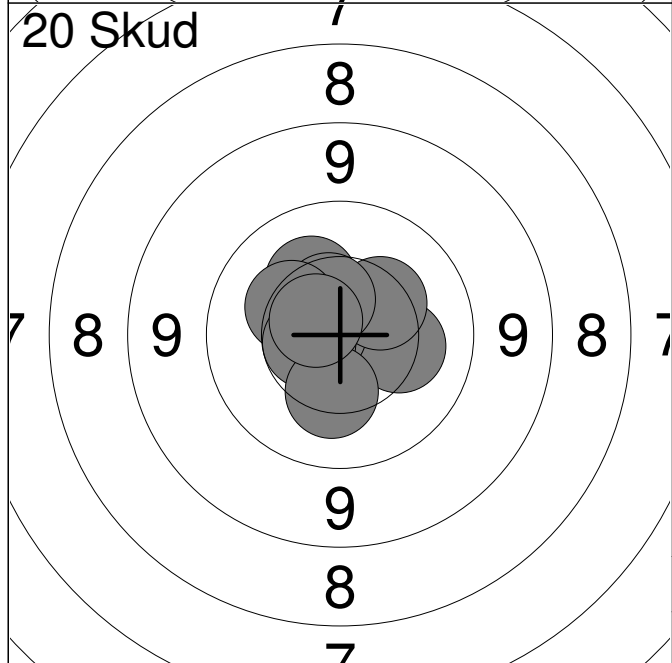

11:	10.3	→
12:	10.7x	←
13:	10.4	↗
14:	10.4	↗
15:	10.3	↗
16:	10.5	↗
17:	10.3	↗
18:	10.6	←
19:	10.3	↘
20:	10.6x	↗
<b>Serie</b>		<b>100.0</b>
<b>Total</b>		<b>200.0</b>

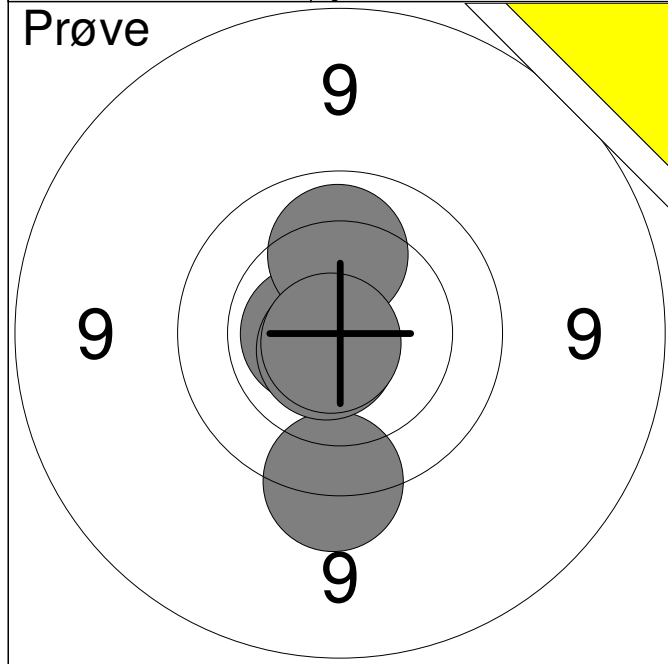

1:	9.6	↓
2:	10.6x	←
3:	10.7x	↙
4:	10.1	↑
5:	10.8x	↘
<b>Serie</b>		<b>49.0</b>
<b>Total</b>		<b>0.0</b>

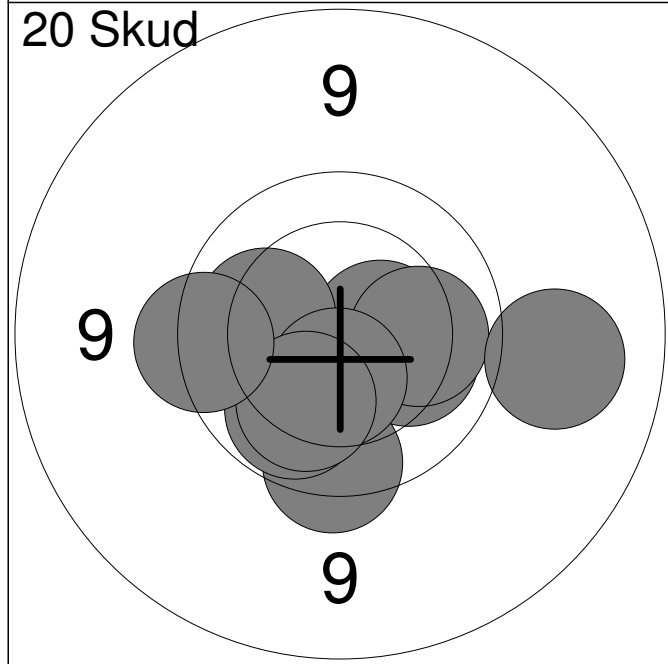

1:	10.2	→
2:	9.7	↓
3:	10.5x	→
4:	10.1	→
5:	10.0	↙
6:	10.1	←
7:	10.5	↓
8:	9.2	→
9:	10.1	↙
10:	9.7	←
<b>Serie</b>		<b>97.0</b>
<b>Total</b>		<b>97.0</b>

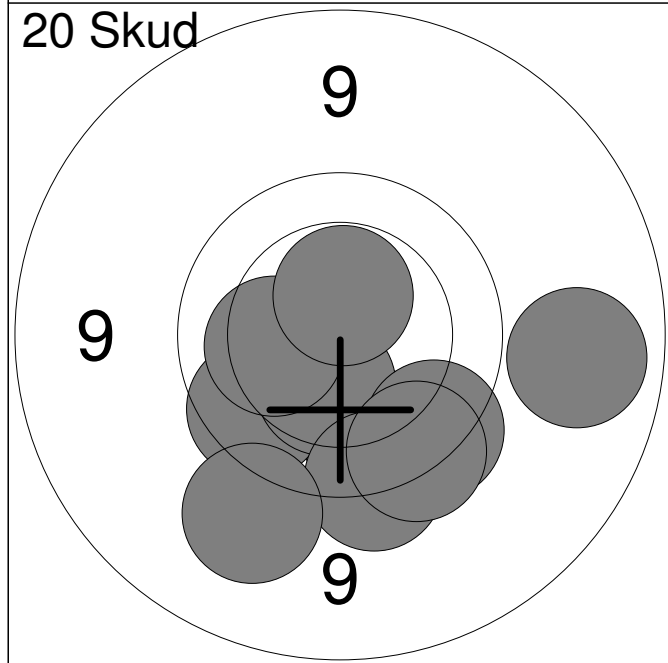

11:	9.9	↓
12:	9.8	↙
13:	10.4	↓
14:	9.1	→
15:	9.6	↓
16:	9.3	↙
17:	9.7	↘
18:	10.2	←
19:	9.7	↓
20:	10.5x	↑
<b>Serie</b>		<b>93.0</b>
<b>Total</b>		<b>190.0</b>

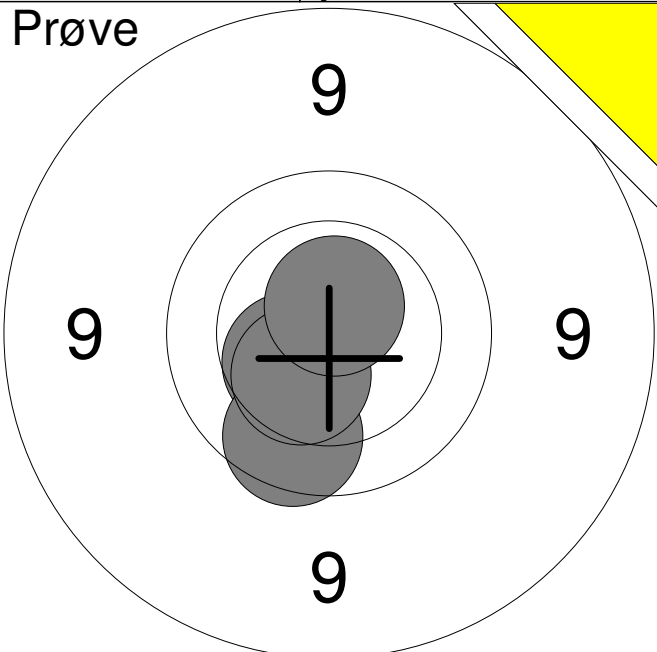
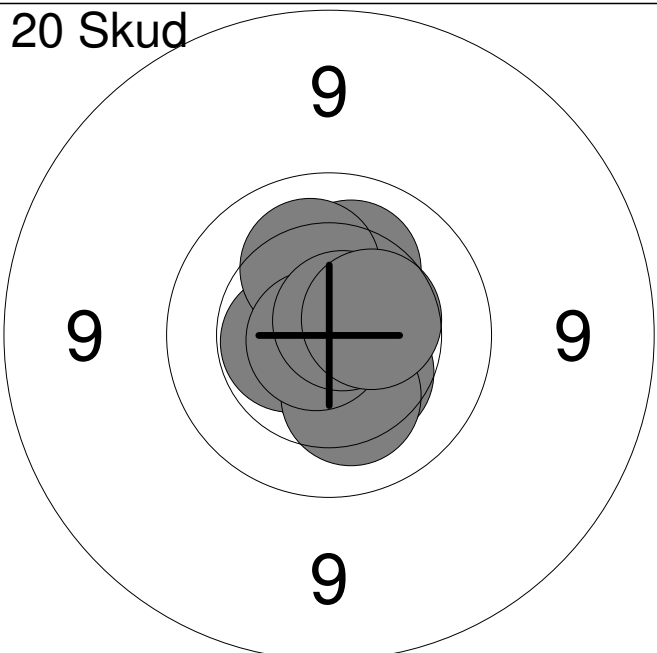
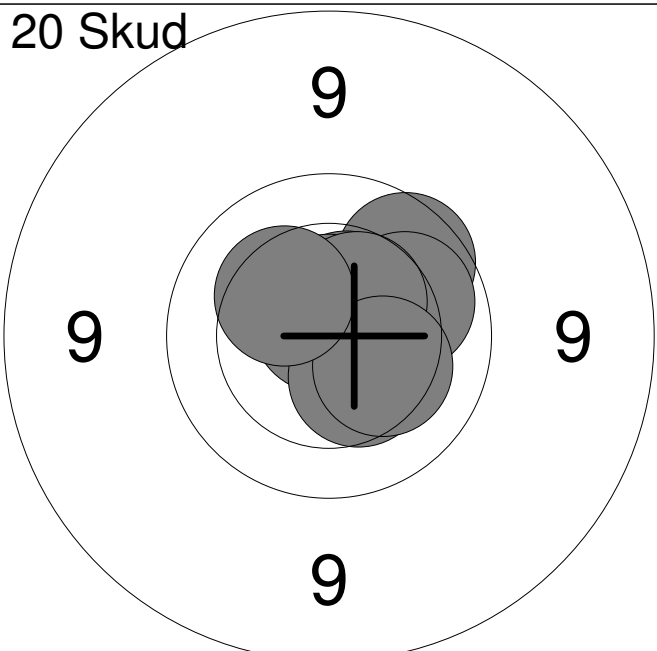
Hold	Skive	Pernille Holst Andersen	
15	10	Skf. Kimbrenne	J1
15m	Jyllandsstævne 2015		Aalborg Skyttekreds
11.02.2015			
Prøve		1: 10.4 ↙	
		2: 9.8 ↓	
		3: 10.4 ↙	
		4: 10.7x ↑	
	Serie	39.0	
	Total	0.0	
20 Skud		1: 10.9x →	
		2: 10.4 ↓	
		3: 10.5x ↓	
		4: 10.5x ←	
		5: 10.3 ↓	
		6: 10.2 ↑	
		7: 10.2 ↑	
		8: 10.8x ←	
		9: 10.7x ↗	
		10: 10.5 →	
	Serie	100.0	
	Total	100.0	
20 Skud		11: 10.8x ↑	
		12: 9.9 ↗	
		13: 10.6x →	
		14: 10.5x ↑	
		15: 10.6x ↑	
		16: 10.1 →	
		17: 10.5 ↗	
		18: 10.4 ↓	
		19: 10.3 ↓	
		20: 10.3 ↑	
	Serie	99.0	
	Total	199.0	

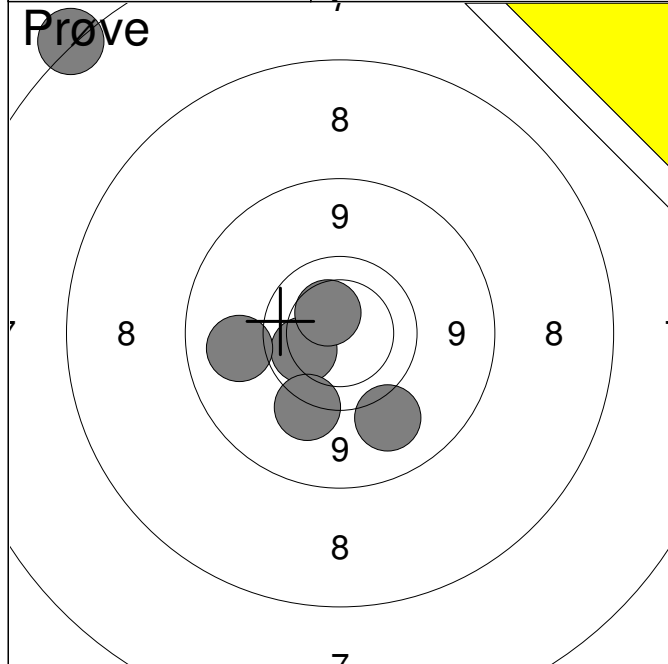

1:	6.6	↗
2:	10.0	↖
3:	9.2	↖
4:	9.3	↘
5:	9.5	↘
6:	10.4	↗

<b>Serie</b>	<b>53.0</b>
<b>Total</b>	<b>0.0</b>

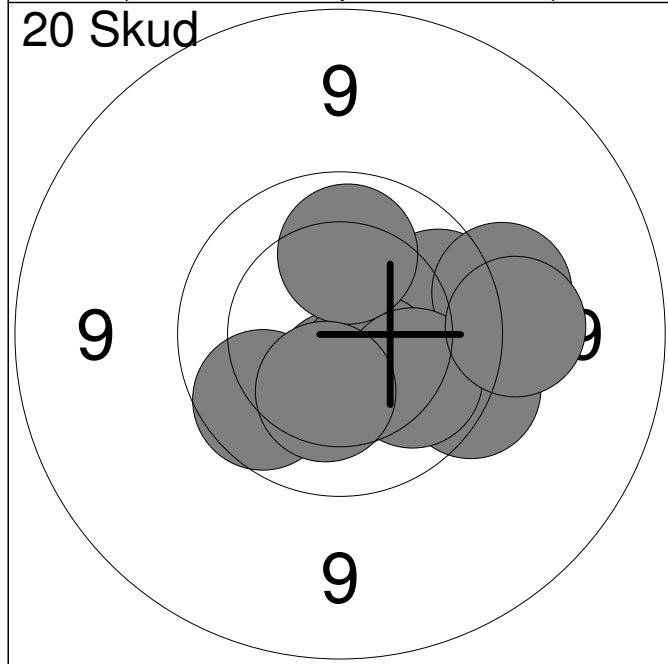

1:	10.5	↓
2:	9.9	→
3:	9.6	→
4:	9.5	→
5:	9.9	↖
6:	10.5	↘
7:	10.1	↑
8:	10.0	↘
9:	9.4	→
10:	10.3	↓

<b>Serie</b>	<b>95.0</b>
<b>Total</b>	<b>95.0</b>

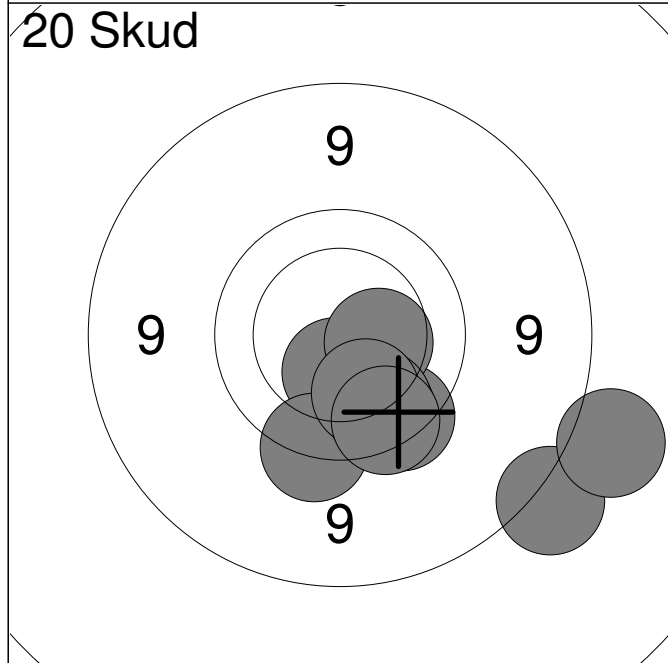

11:	8.6	↘
12:	10.4	↓
13:	9.6	↓
14:	9.7	↘
15:	9.8	↘
16:	10.4	→
17:	9.9	↘
18:	8.5	→
19:	10.1	↘
20:	9.7	↘

<b>Serie</b>	<b>91.0</b>
<b>Total</b>	<b>186.0</b>

Hold <b>16</b>	Skive <b>3</b>	<b>Rasmus M. Larsen</b>	
-------------------	-------------------	-------------------------	--

15m	Vilsted Skf.	MÅ1
-----	--------------	-----

11.02.2015	Jyllandsstævne 2015	Aalborg Skyttekreds
------------	---------------------	---------------------

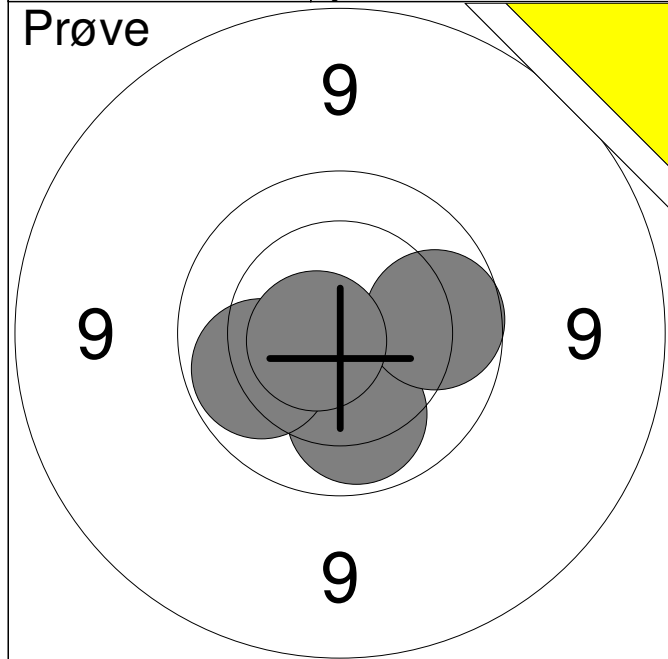

1:	10.1	↓
2:	9.9	→
3:	10.0	←
4:	10.7x	←
<b>Serie</b>		<b>39.0</b>
<b>Total</b>		<b>0.0</b>

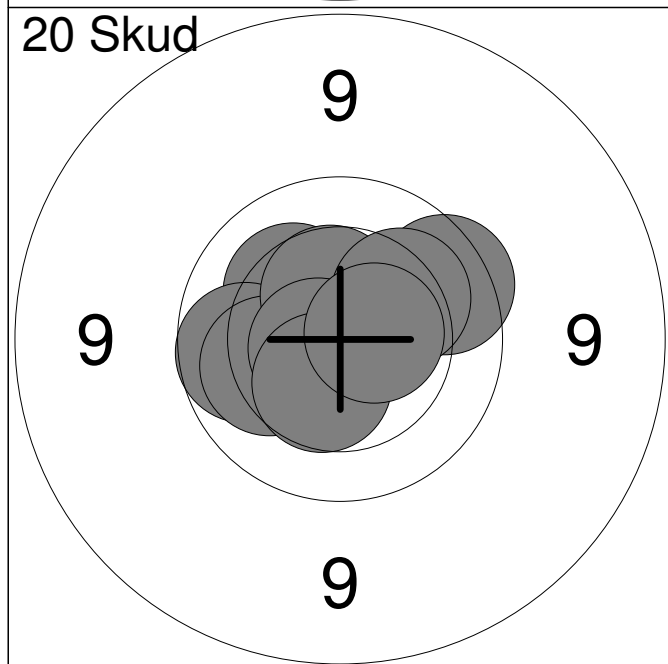

1:	10.2	↖
2:	9.9	←
3:	10.1	←
4:	10.6x	↓
5:	10.5	↑
6:	9.8	↗
7:	10.2	↗
8:	10.7x	←
9:	10.4	↓
10:	10.6x	→
<b>Serie</b>		<b>98.0</b>
<b>Total</b>		<b>98.0</b>

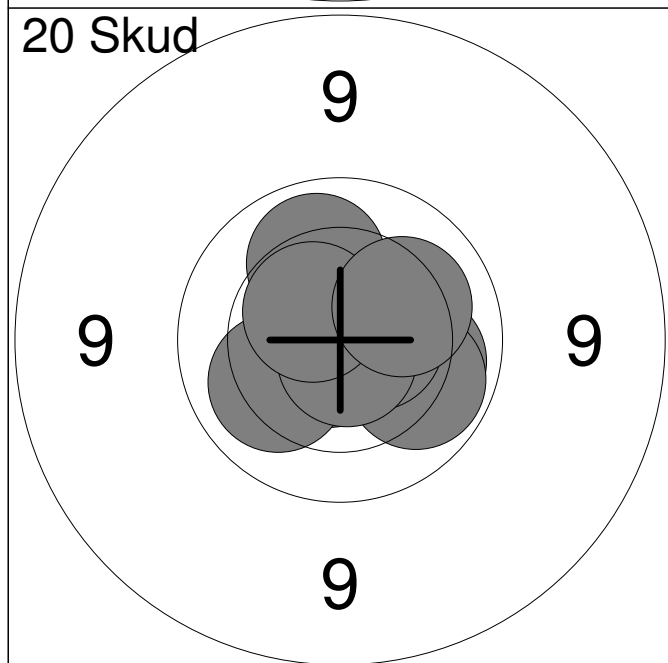

11:	10.6x	↗
12:	10.1	→
13:	10.7x	↓
14:	10.0	→
15:	10.1	←
16:	10.6x	→
17:	10.8x	↓
18:	10.1	↑
19:	10.5x	↖
20:	10.2	↗
<b>Serie</b>		<b>100.0</b>
<b>Total</b>		<b>198.0</b>

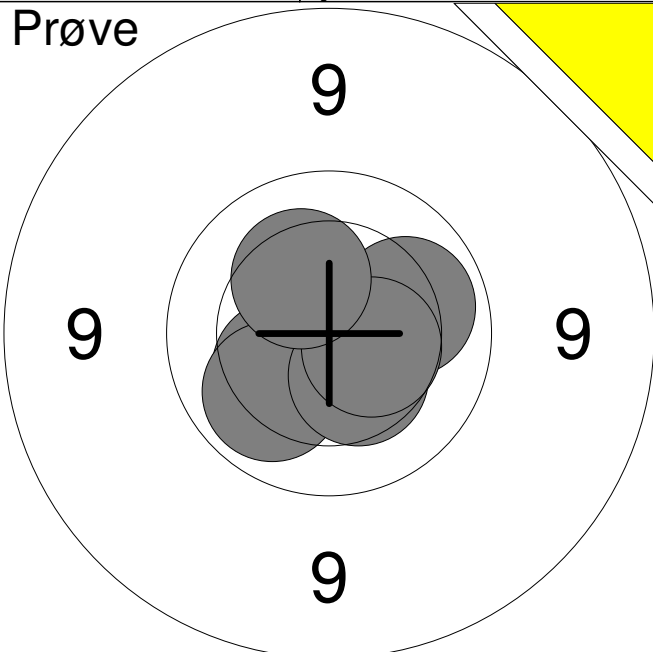
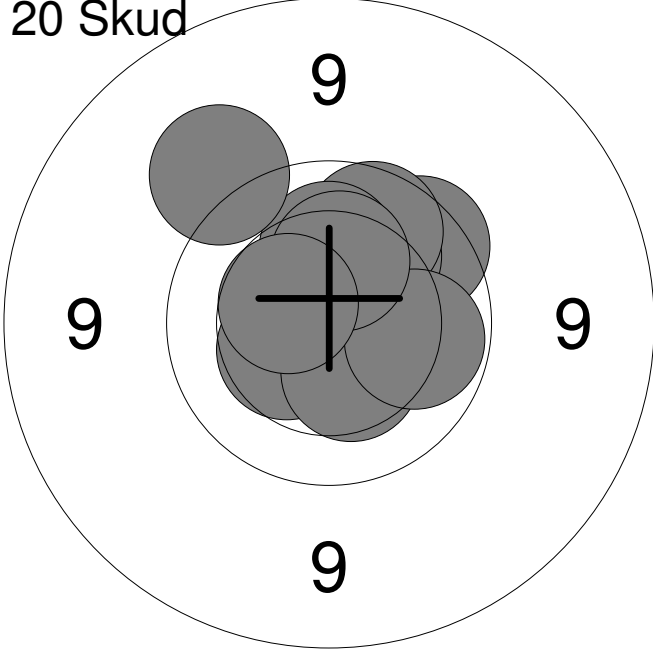
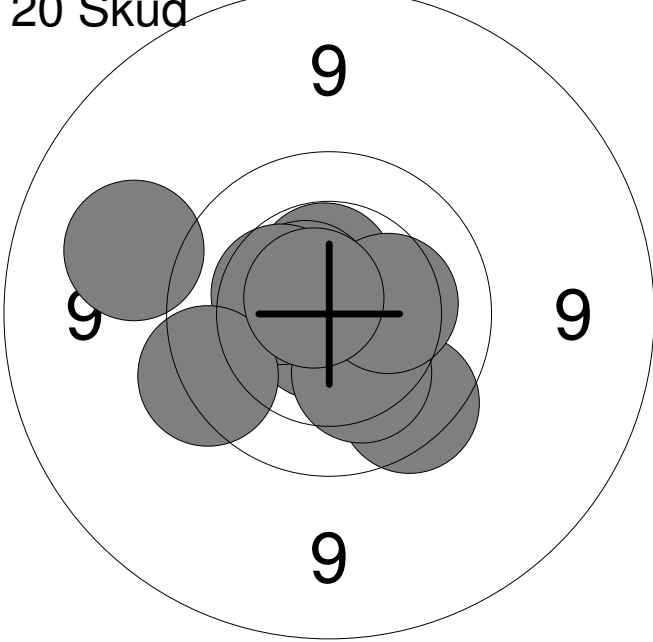

Hold	Skive	Charlotte Larsen		
16	4	Vilsted Skf.		MÅ2
15m	Jyllandsstævne 2015		Aalborg Skyttekreds	
11.02.2015				
Prøve		1:	10.3	↙
		2:	10.1	↙
		3:	10.1	→
		4:	10.4	↘
		5:	10.5	↘
		6:	10.3	↗
		<b>Serie</b>	<b>60.0</b>	
		<b>Total</b>	<b>0.0</b>	
20 Skud		1:	9.8	↗
		2:	10.1	↗
		3:	9.9	↗
		4:	10.4	↙
		5:	10.4	↘
		6:	10.2	↑
		7:	10.0	→
		8:	10.3	↑
		9:	9.4	↗
		10:	10.5	↖
		<b>Serie</b>	<b>97.0</b>	
		<b>Total</b>	<b>97.0</b>	
20 Skud		11:	9.8	↘
		12:	10.8x	↙
		13:	10.5x	↑
		14:	10.2	↘
		15:	10.6x	↗
		16:	10.4	↗
		17:	10.3	→
		18:	9.7	↙
		19:	10.7x	↗
		20:	9.3	↖
		<b>Serie</b>	<b>97.0</b>	
		<b>Total</b>	<b>194.0</b>	

Hold <b>16</b>	Skive <b>9</b>	<b>Ruby Larsen</b>	
-------------------	-------------------	--------------------	--

15m	Vilsted Skf.	MV2
-----	--------------	-----

11.02.2015	Jyllandsstævne 2015	Aalborg Skyttekreds
------------	---------------------	---------------------

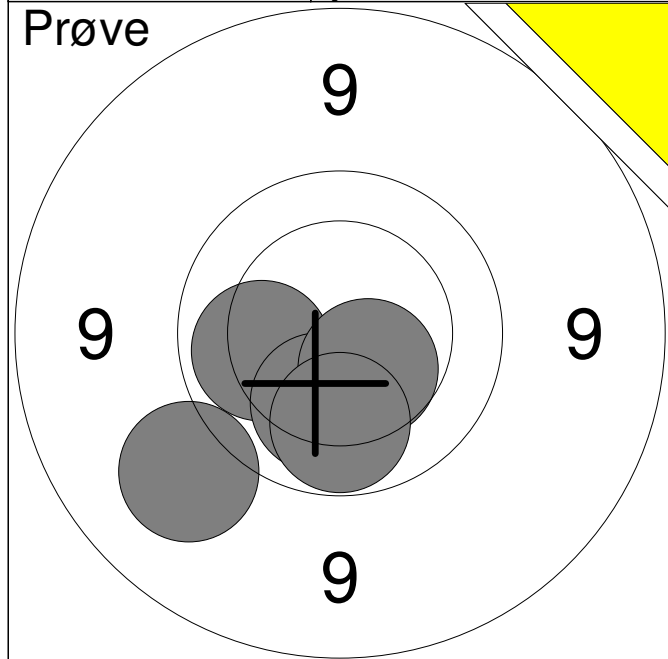

1:	9.3	↘
2:	10.1	←
3:	10.2	↘
4:	10.5	↘
5:	10.0	↓
<b>Serie</b>		<b>49.0</b>
<b>Total</b>		<b>0.0</b>

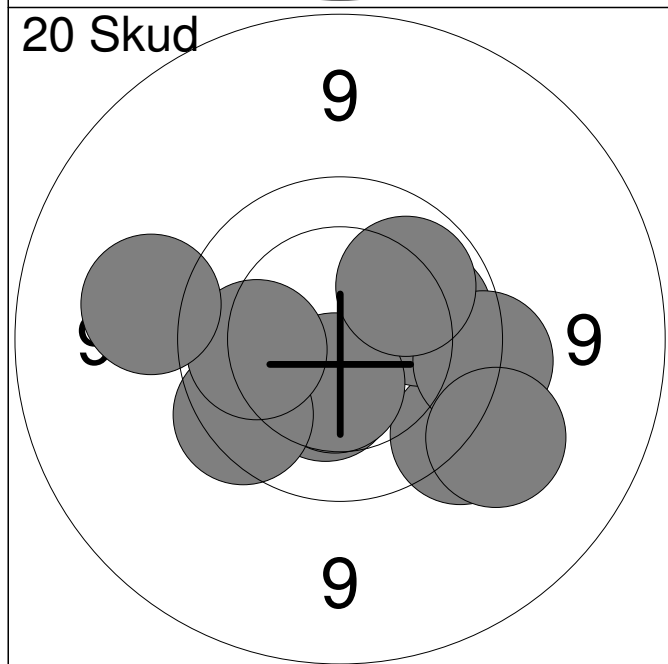

1:	9.6	↘
2:	10.4	↓
3:	10.0	→
4:	9.6	→
5:	10.5	↓
6:	9.8	↙
7:	10.0	←
8:	9.4	↘
9:	10.0	↗
10:	9.3	←
<b>Serie</b>		<b>95.0</b>
<b>Total</b>		<b>95.0</b>

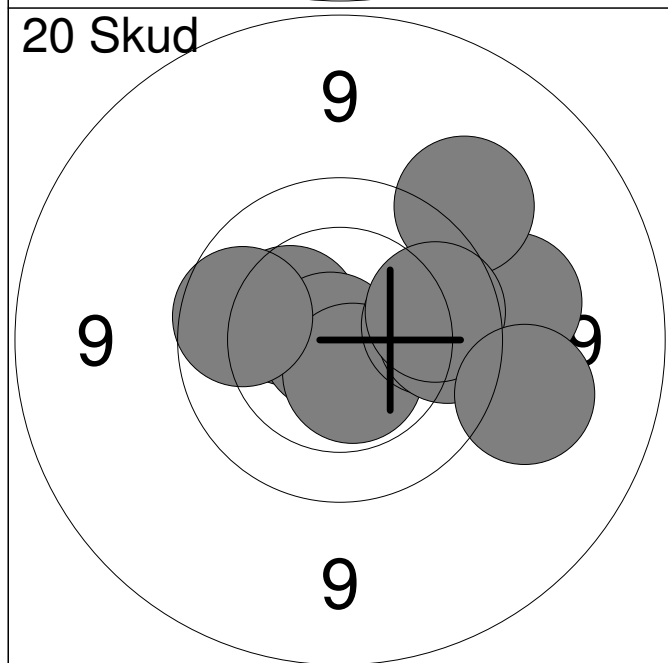

11:	10.4	↖
12:	10.8x	←
13:	10.6x	↓
14:	9.9	→
15:	9.9	→
16:	9.4	→
17:	9.4	↗
18:	9.9	→
19:	9.9	↖
20:	9.3	↘
<b>Serie</b>		<b>93.0</b>
<b>Total</b>		<b>188.0</b>

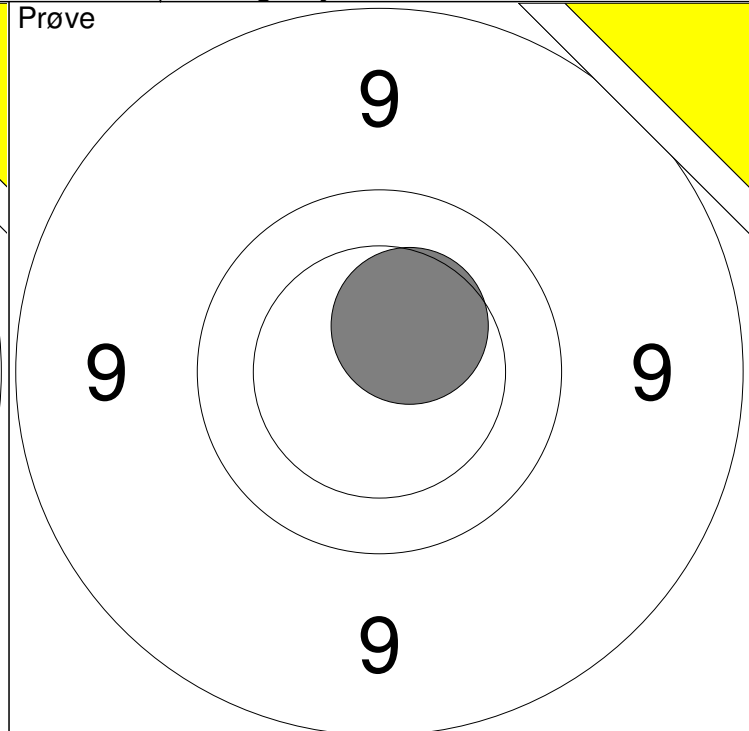
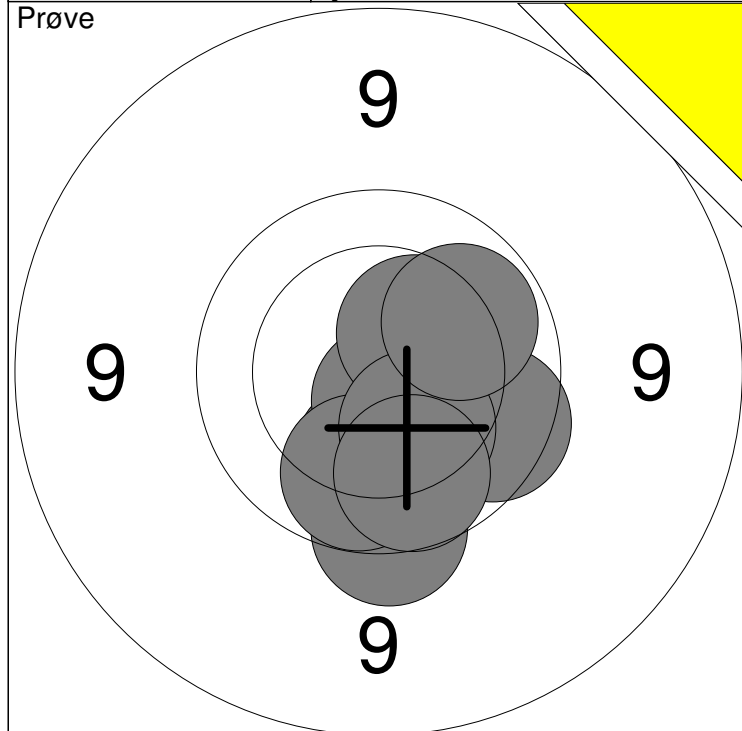

1: 10.1 ↓	6: 10.0 ↓	Serie 97
2: 9.7 ↓	7: 10.4 ↗	
3: 10.1 ↓	8: 10.3 ↓	Total 0
4: 10.7x ↓	9: 9.9 ↓	
5: 9.8 ↘	10: 10.0 ↗	

11: 10.4 ↗	Serie 10
	Total 0

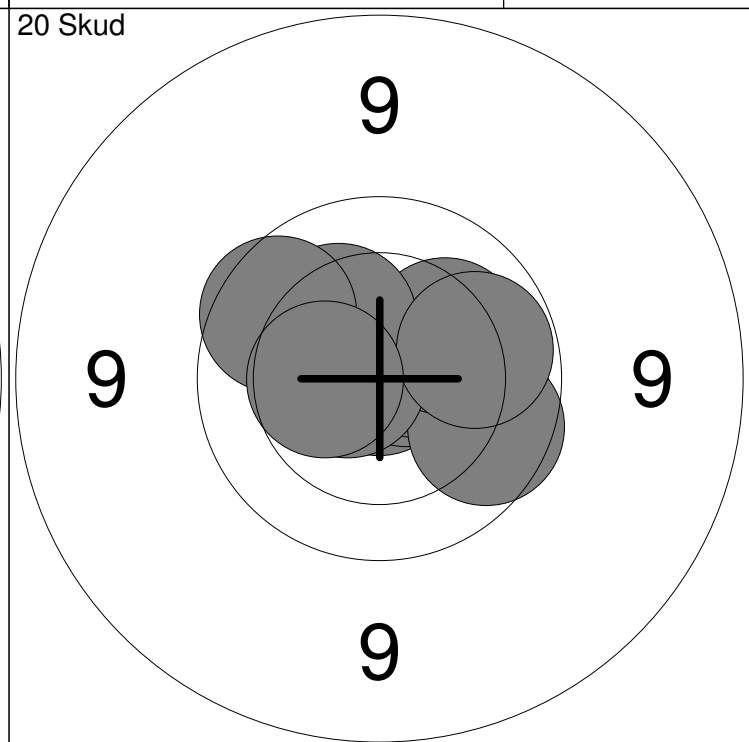
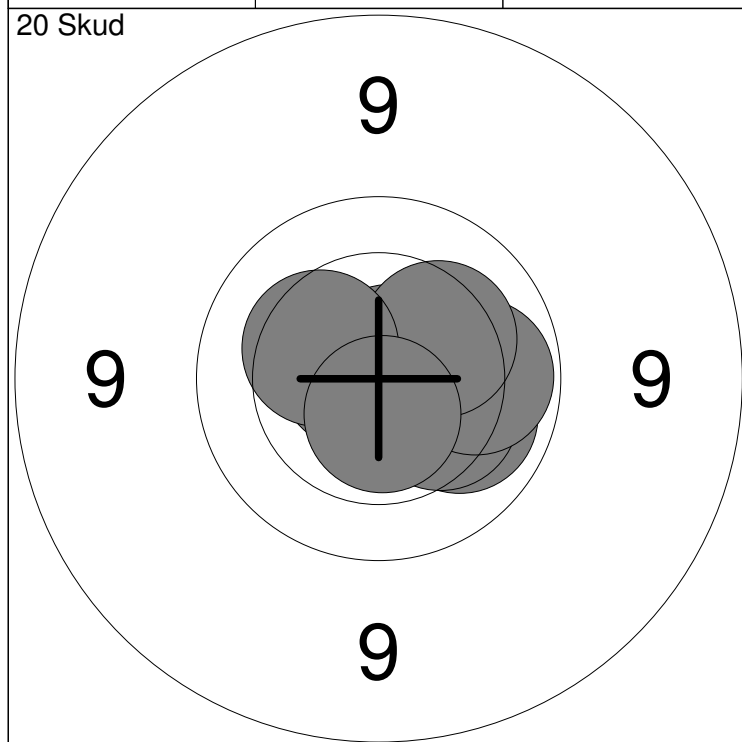

1: 10.6x ↓	6: 10.0 →	Serie 100
2: 10.1 ↓	7: 10.8x ↗	
3: 10.3 ↓	8: 10.3 ↗	Total 100
4: 10.7x ↖	9: 10.3 ↖	
5: 10.8x ↓	10: 10.6x ↓	

11: 10.9x ↗	16: 10.6x ←	Serie 98
12: 10.7x ↗	17: 10.3 ↗	
13: 10.6x ↗	18: 9.9 ↖	Total 198
14: 9.9 →	19: 10.0 →	
15: 10.2 ↗	20: 10.4 ←	

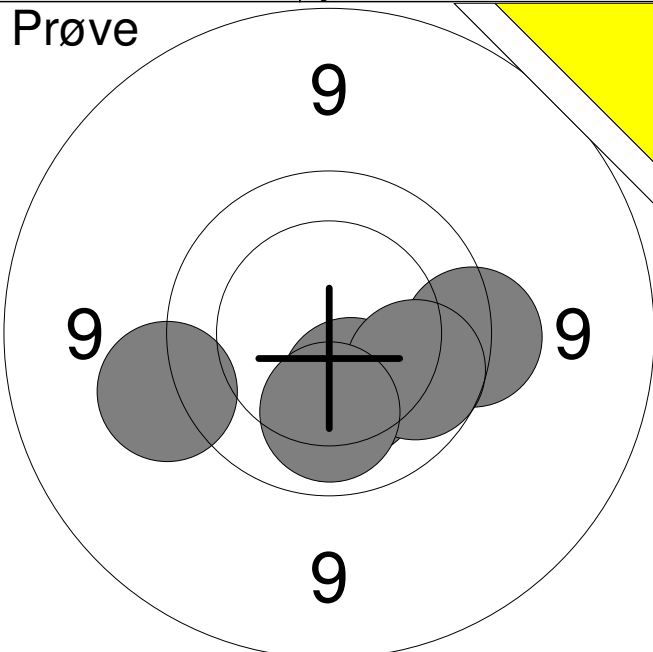
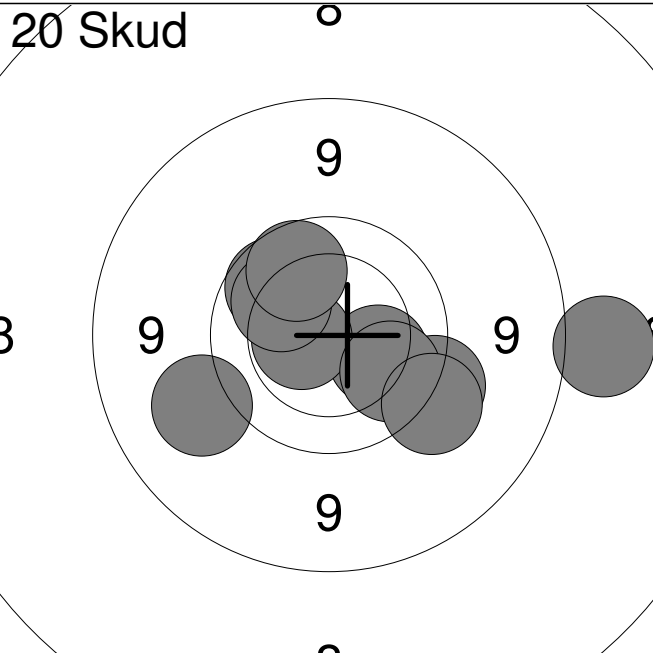
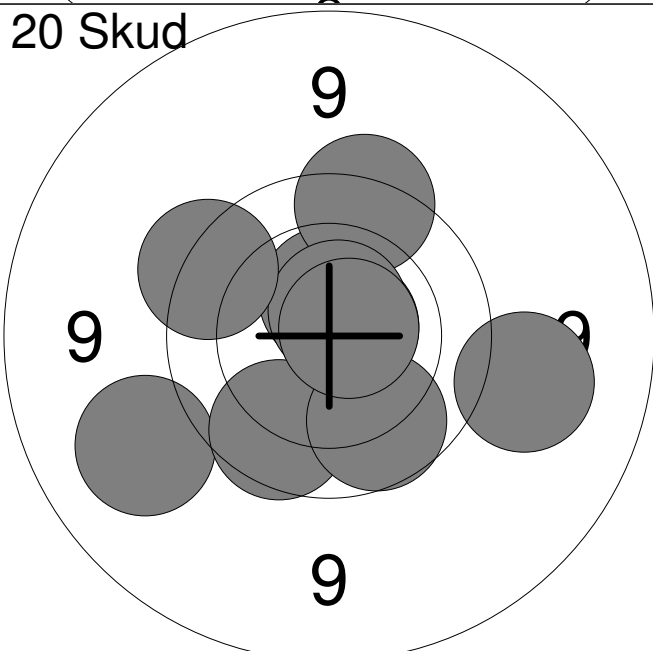
Hold	Skive	Martin Jensen		
16	11	Løgstør Sportsskytteklub		UNG
11.02.2015	Jyllandsstævne 2015	Aalborg Skyttekreds		
Prøve		1:	10.3	↓
		2:	9.5	←
		3:	9.6	→
		4:	9.9	↘
		5:	10.1	↓
		<b>Serie</b>	<b>47.0</b>	
		<b>Total</b>	<b>0.0</b>	
20 Skud		1:	9.9	↗
		2:	8.5	→
		3:	10.2	↘
		4:	9.5	↘
		5:	10.5x	←
		6:	10.1	↗
		7:	9.9	↗
		8:	9.9	↘
		9:	9.5	↘
		10:	9.3	↙
		<b>Serie</b>	<b>92.0</b>	
		<b>Total</b>	<b>92.0</b>	
20 Skud		11:	10.5x	↑
		12:	9.2	↙
		13:	9.7	↑
		14:	9.3	→
		15:	10.7x	↗
		16:	10.7x	↑
		17:	9.9	↘
		18:	9.7	↗
		19:	9.9	↘
		20:	10.7x	↗
		<b>Serie</b>	<b>94.0</b>	
		<b>Total</b>	<b>186.0</b>	

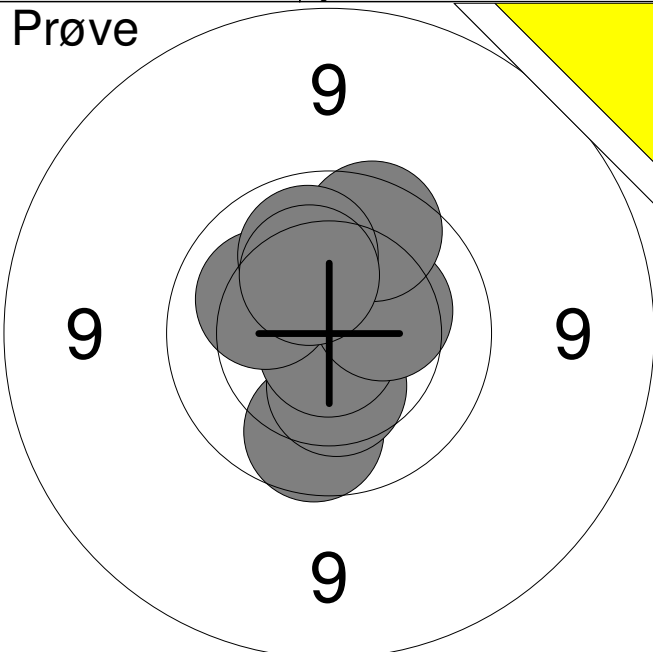
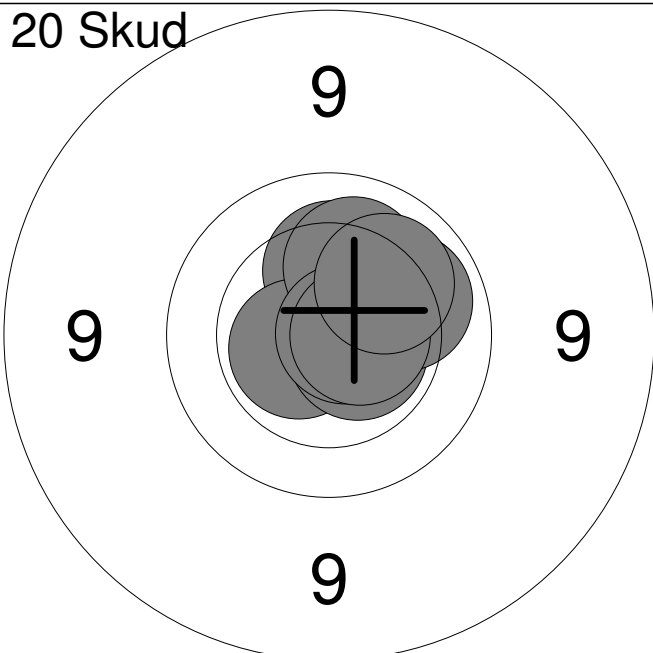
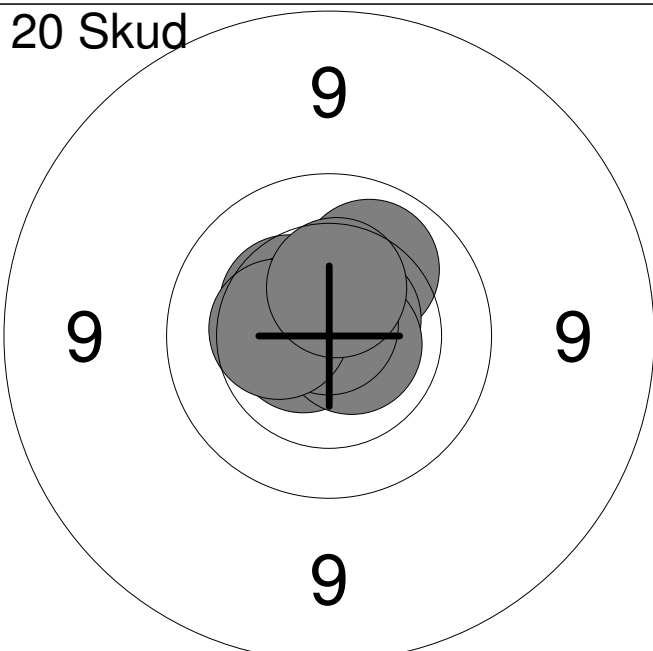
Hold	Skive	Christian Frost		
16	12	Aalborg Skyttekreds		ÅK1
15m	Jyllandsstævne 2015		Aalborg Skyttekreds	
11.02.2015	Jyllandsstævne 2015		Aalborg Skyttekreds	
Prøve		1: 9.9	↓	
		2: 10.4	↓	
		3: 10.8x	↓	
		4: 10.3	→	
		5: 9.8	↑	
		6: 10.2	↖	
		7: 10.1	↑	
		8: 10.3	↑	
		<b>Serie</b>	<b>78.0</b>	
		<b>Total</b>	<b>0.0</b>	
20 Skud		1: 10.4	↗	
		2: 10.3	↑	
		3: 10.6x	↖	
		4: 10.2	↑	
		5: 10.6x	→	
		6: 10.1	↗	
		7: 10.8x	→	
		8: 10.1	↗	
		9: 10.6x	→	
		10: 10.1	↗	
		<b>Serie</b>	<b>100.0</b>	
		<b>Total</b>	<b>100.0</b>	
20 Skud		11: 10.4	↖	
		12: 10.5x	↖	
		13: 10.1	↑	
		14: 10.6x	↖	
		15: 10.7x	↖	
		16: 10.6x	↗	
		17: 10.7x	→	
		18: 10.8x	↑	
		19: 10.4	↖	
		20: 10.4	↑	
		<b>Serie</b>	<b>100.0</b>	
		<b>Total</b>	<b>200.0</b>	

Hold <b>17</b>	Skive <b>1</b>	<b>Nicoline V. Knapp</b>	
-------------------	-------------------	--------------------------	--

15m	Mou & Omegns Skf.	BK2
-----	-------------------	-----

11.02.2015	Jyllandsstævne 2015	Aalborg Skyttekreds
------------	---------------------	---------------------

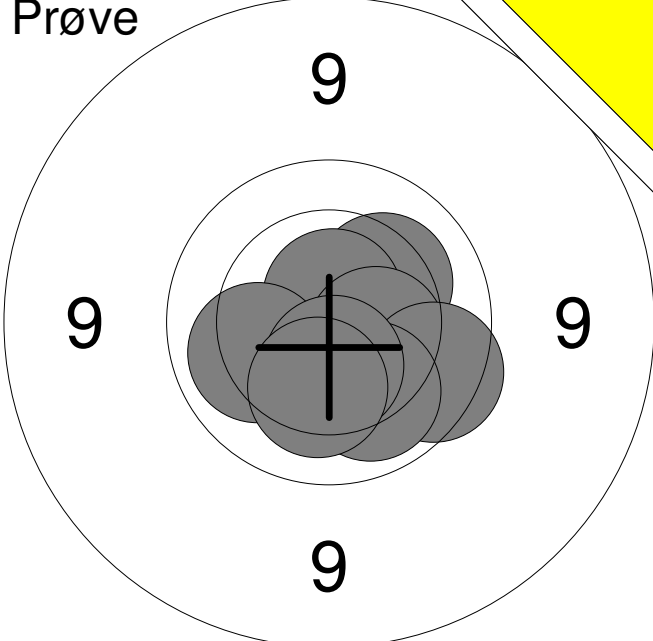
<b>Prøve</b> 	1:	10.3	↘
	2:	10.2	↗
	3:	10.7x	↑
	4:	10.4	↘
	5:	10.3	↘
	6:	10.1	↙
	7:	9.8	↘
	8:	10.1	↘
	9:	10.5	↘
	10:	10.2	↘
	<b>Serie</b>		<b>99.0</b>
<b>Total</b>		<b>0.0</b>	

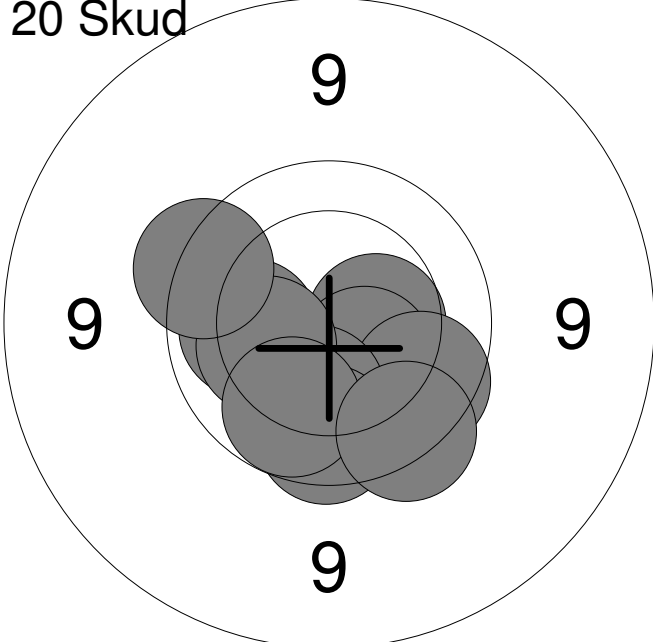
<b>20 Skud</b> 	1:	10.4	→
	2:	10.4	↘
	3:	10.1	←
	4:	9.9	↘
	5:	10.2	↘
	6:	10.2	←
	7:	9.8	↘
	8:	10.0	↘
	9:	9.7	↘
	10:	9.7	↗
	<b>Serie</b>		<b>96.0</b>
<b>Total</b>		<b>96.0</b>	

<b>20 Skud</b> 	11:	10.9x	↗
	12:	10.3	↗
	13:	10.5	↘
	14:	10.0	↘
	15:	10.3	↗
	16:	10.3	↗
	17:	9.8	↗
	18:	9.9	↗
	19:	10.6x	↗
	20:	10.5	↗
	<b>Serie</b>		<b>98.0</b>
<b>Total</b>		<b>194.0</b>	

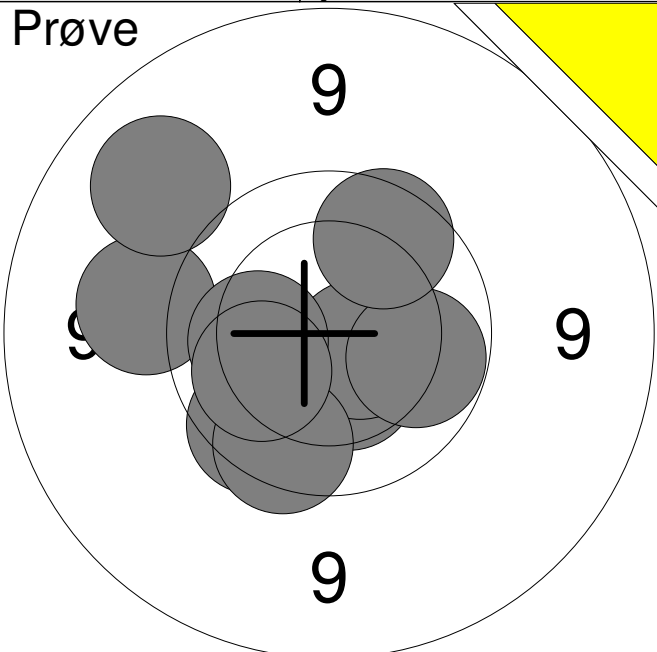
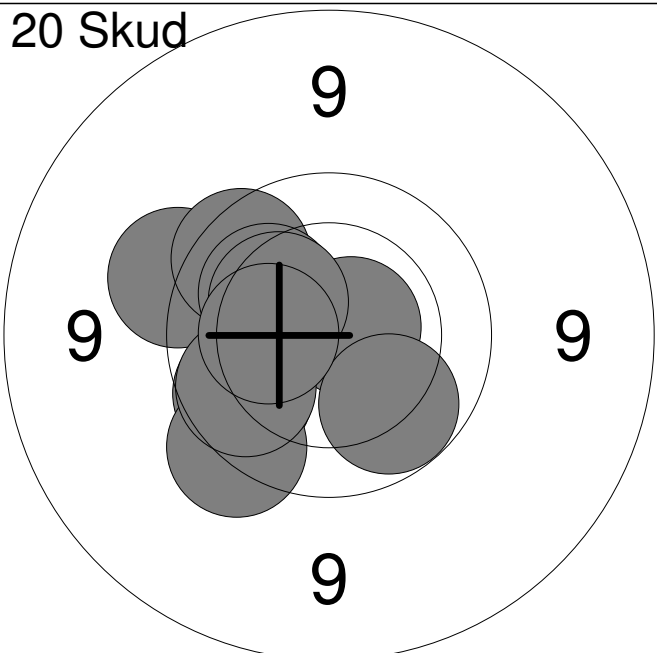
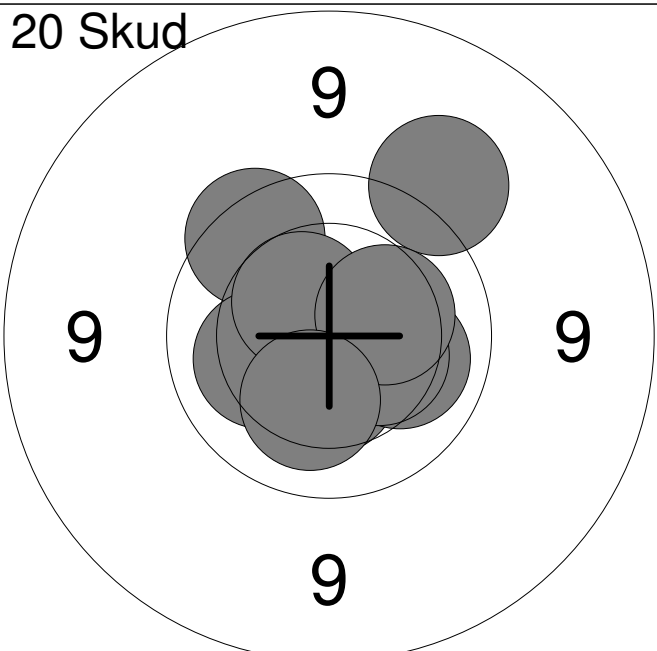
Hold	Skive	Nina Guldbæk Larsen	
17	2	Mou & Omegns Skf.	BK2
15m			
11.02.2015	Jyllandsstævne 2015	Aalborg Skyttekreds	
<b>Prøve</b> 	1:	9.4	←
	2:	9.1	↗
	3:	10.4	↓
	4:	10.6x	↓
	5:	9.8	↙
	6:	10.2	←
	7:	9.8	↓
	8:	10.0	→
	9:	10.1	↙
	10:	9.8	↗
	<b>Serie</b>		<b>95.0</b>
<b>Total</b>		<b>0.0</b>	
<b>20 Skud</b> 	1:	9.5	↗
	2:	9.8	↗
	3:	10.2	↗
	4:	9.9	↙
	5:	9.6	↙
	6:	10.7x	→
	7:	9.9	↙
	8:	10.3	↗
	9:	10.0	↓
	10:	10.3	←
<b>Serie</b>		<b>95.0</b>	
<b>Total</b>		<b>95.0</b>	
<b>20 Skud</b> 	11:	10.6x	↘
	12:	10.4	↓
	13:	9.8	↗
	14:	9.4	↗
	15:	10.1	→
	16:	10.2	↙
	17:	10.4	→
	18:	10.5	↗
	19:	10.3	→
	20:	10.2	↓
<b>Serie</b>		<b>98.0</b>	
<b>Total</b>		<b>193.0</b>	

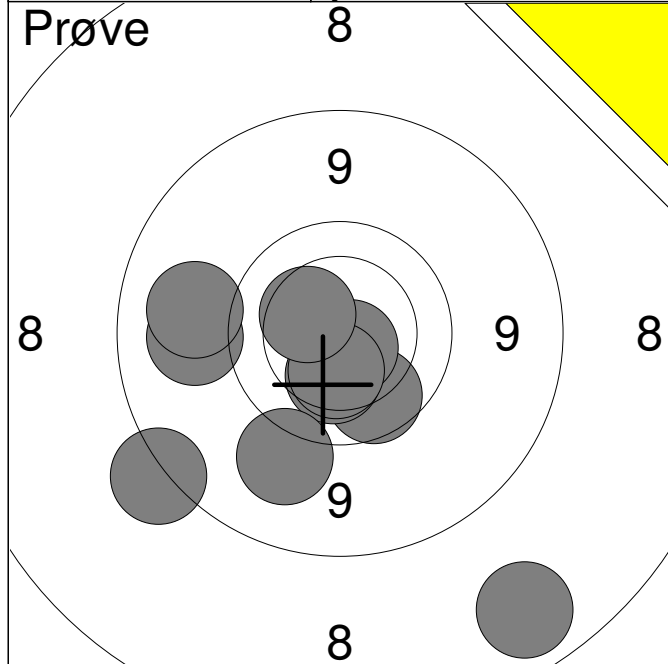

1:	8.0	↘
2:	9.9	↘
3:	10.3	↘
4:	9.3	↘
5:	9.2	←
6:	10.7x	↘
7:	10.4	↘
8:	8.6	←
9:	9.2	←
10:	10.4	↗

<b>Serie</b>	<b>92.0</b>
<b>Total</b>	<b>0.0</b>

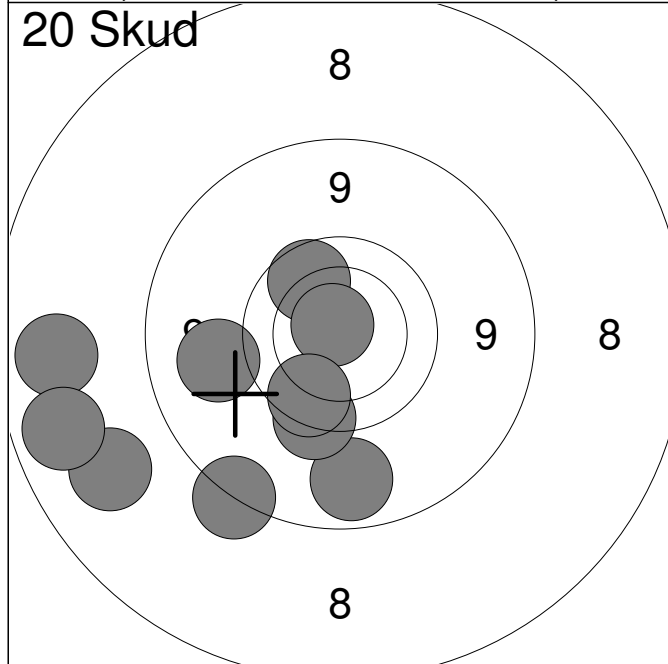

1:	8.7	↘
2:	9.2	←
3:	9.9	↗
4:	8.2	←
5:	9.0	↘
6:	8.1	←
7:	9.6	↘
8:	10.7x	↗
9:	8.0	←
10:	9.8	↘

<b>Serie</b>	<b>87.0</b>
<b>Total</b>	<b>87.0</b>

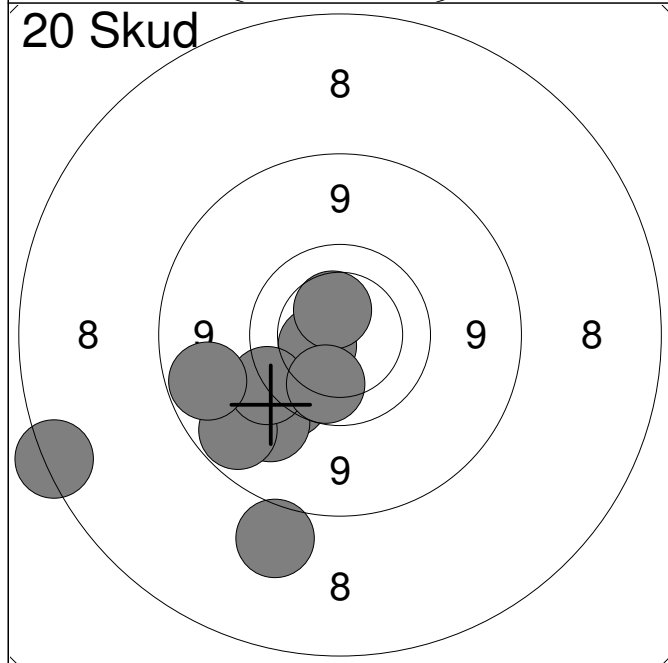

11:	9.6	↘
12:	9.3	↘
13:	9.0	↘
14:	8.4	↘
15:	10.5	←
16:	10.4	↗
17:	9.5	↘
18:	9.0	←
19:	7.7	←
20:	10.0	↘

<b>Serie</b>	<b>90.0</b>
<b>Total</b>	<b>177.0</b>

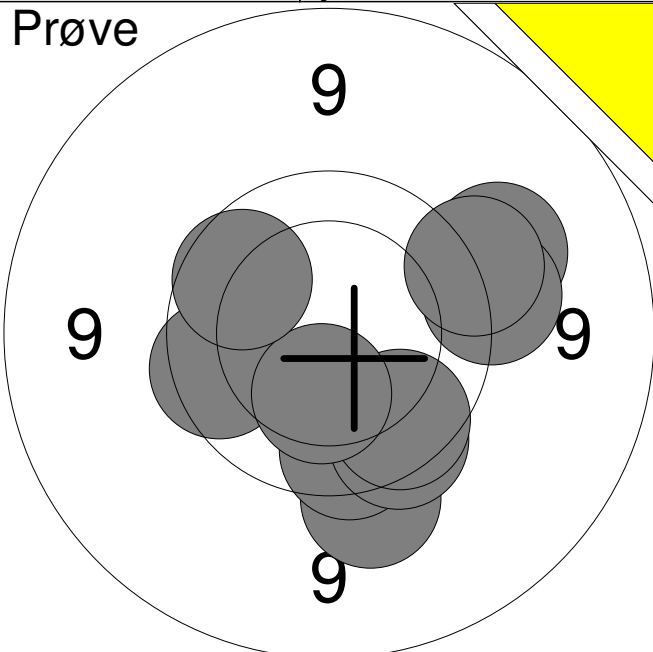
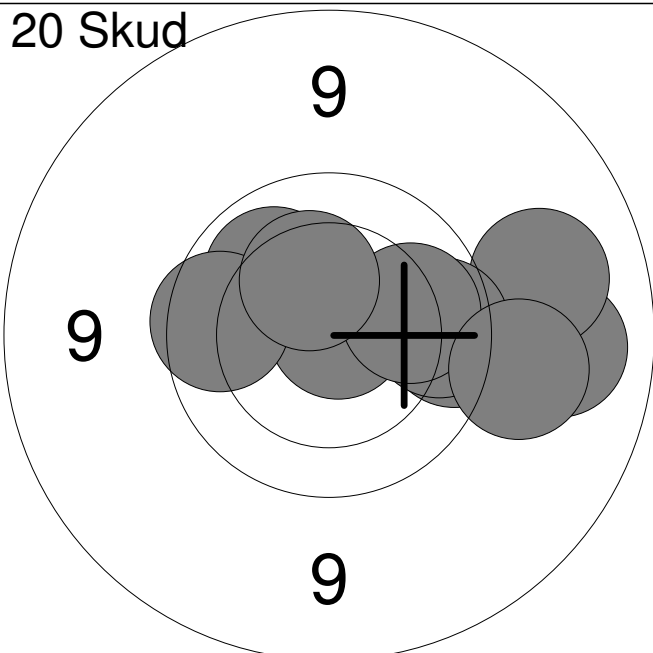
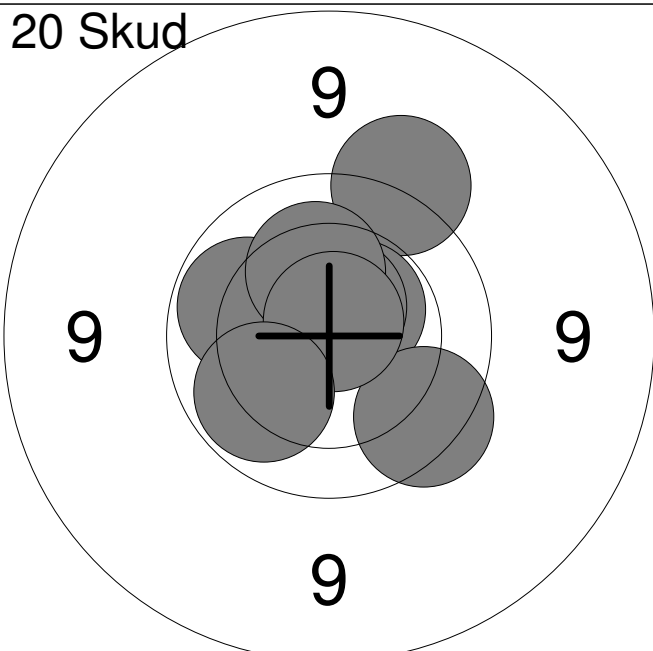

Hold <b>17</b>	Skive <b>4</b>	<b>Jens Niss</b>	
15m	Mou & Omegns Skf.	ÅK2	
11.02.2015	Jyllandsstævne 2015	Aalborg Skyttekreds	
<b>Prøve</b> 	1:	9.4	→
	2:	9.5	↓
	3:	9.8	↓
	4:	9.7	↓
	5:	9.8	↓
	6:	9.8	←
	7:	10.3	↓
	8:	9.5	→
	9:	9.5	→
	10:	9.9	↖
	<b>Serie</b>		<b>91.0</b>
<b>Total</b>		<b>0.0</b>	
<b>20 Skud</b> 	1:	9.1	→
	2:	9.7	→
	3:	9.2	→
	4:	10.8x	↗
	5:	10.1	↗
	6:	9.8	←
	7:	9.8	→
	8:	10.0	→
	9:	9.3	→
	10:	10.3	↖
	<b>Serie</b>		<b>94.0</b>
<b>Total</b>		<b>94.0</b>	
<b>20 Skud</b> 	11:	9.5	↖
	12:	10.5x	↗
	13:	10.1	←
	14:	9.8	↓
	15:	10.4	↗
	16:	10.0	←
	17:	10.6x	↖
	18:	10.2	↖
	19:	10.8x	↖
	20:	10.0	↙
	<b>Serie</b>		<b>98.0</b>
<b>Total</b>		<b>192.0</b>	

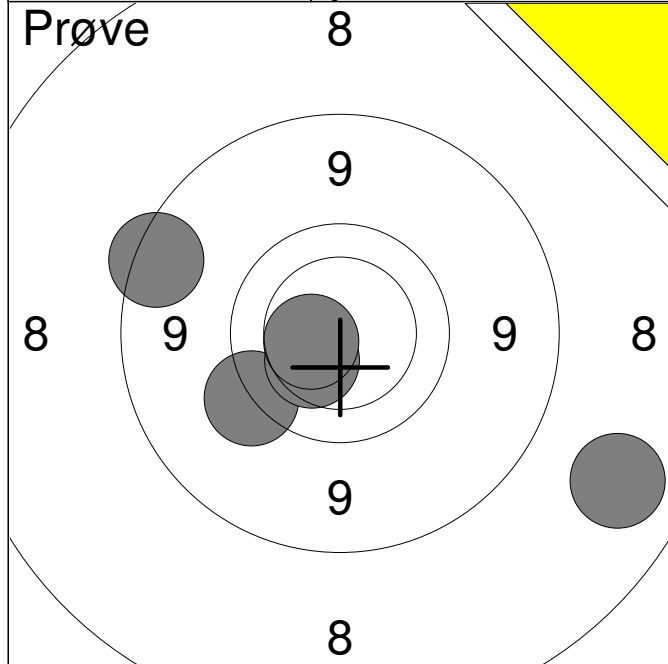

1:	8.1	→
2:	8.8	↖
3:	9.5	↙
4:	10.3	↙
5:	10.5	↖

<b>Serie</b>	<b>45.0</b>
<b>Total</b>	<b>0.0</b>

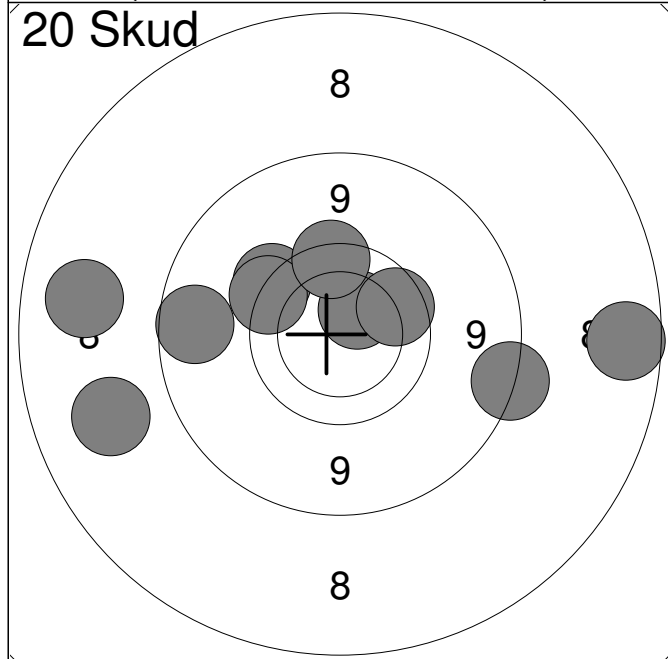

1:	8.2	↖
2:	9.6	↗
3:	9.6	↗
4:	8.7	→
5:	10.4	↗
6:	8.9	↖
7:	8.1	↖
8:	9.8	↗
9:	9.7	↑
10:	7.9	→

<b>Serie</b>	<b>85.0</b>
<b>Total</b>	<b>85.0</b>

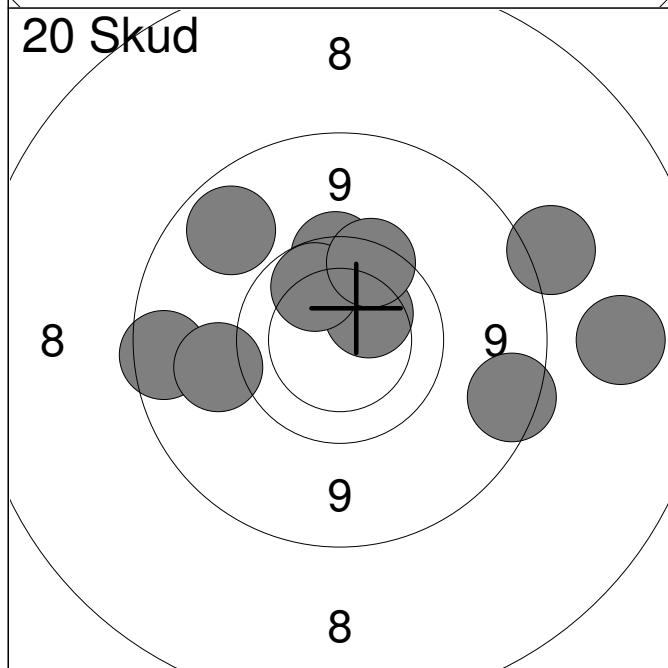

11:	10.3	↗
12:	8.2	→
13:	8.8	→
14:	9.7	↑
15:	8.9	↖
16:	9.0	↗
17:	8.5	→
18:	10.0	↗
19:	9.7	↗
20:	9.3	↖

<b>Serie</b>	<b>88.0</b>
<b>Total</b>	<b>173.0</b>

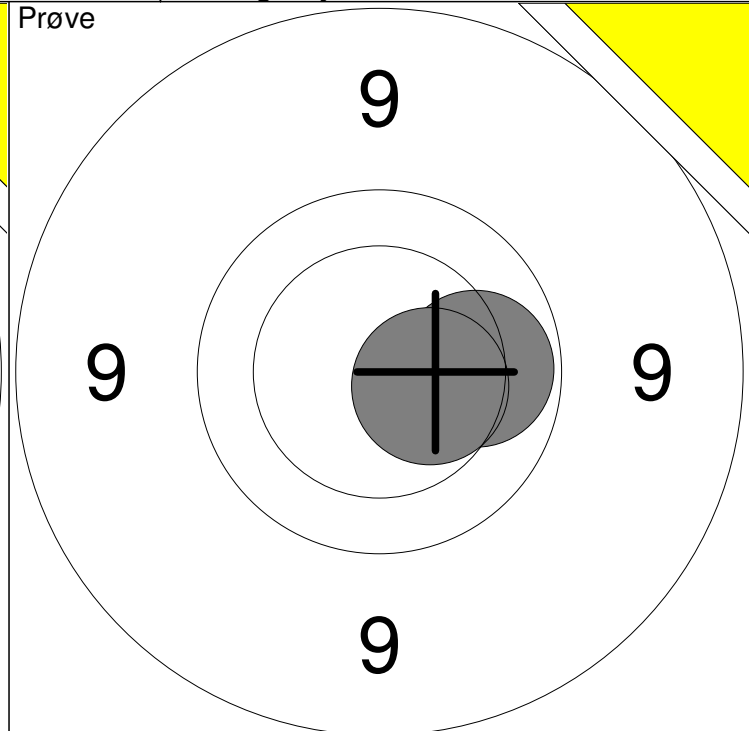
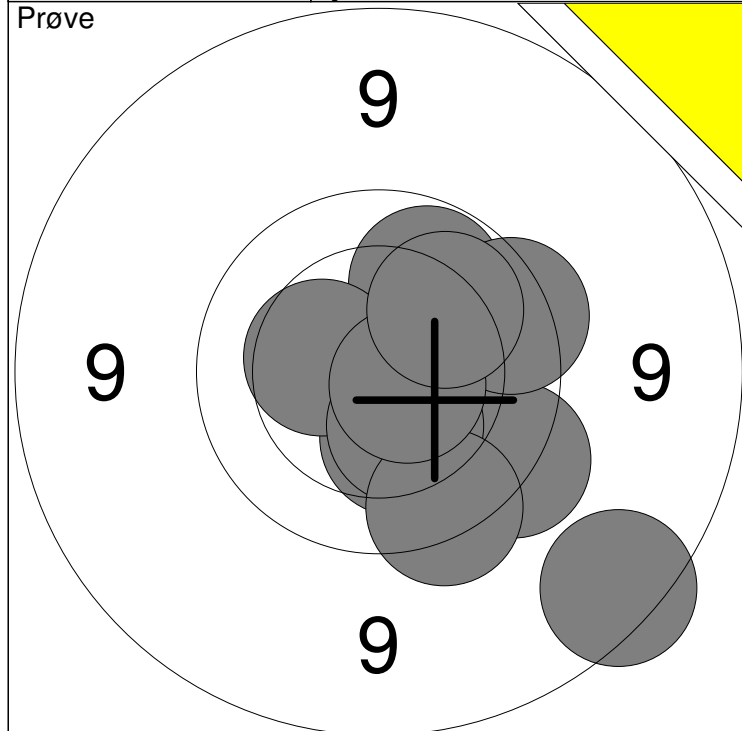

1: 8.8 ↘	6: 9.7 →	Serie	95
2: 9.6 ↘	7: 10.4 ↘		
3: 10.3 ↘	8: 9.7 ↘	Total	0
4: 10.0 ↗	9: 10.6x →		
5: 10.4 ←	10: 10.1 ↗		

11: 10.0 →	Serie	20
12: 10.4 →		
Total		0

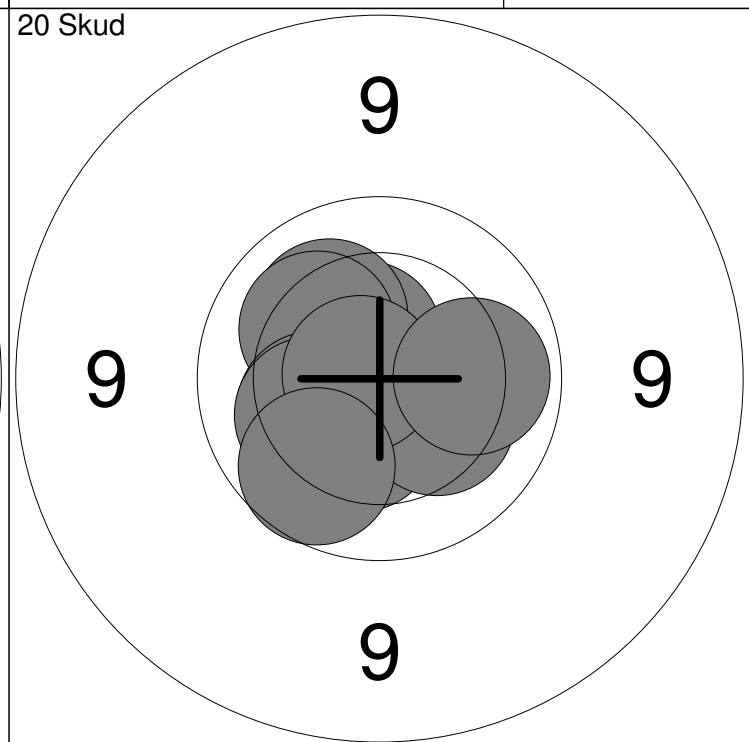
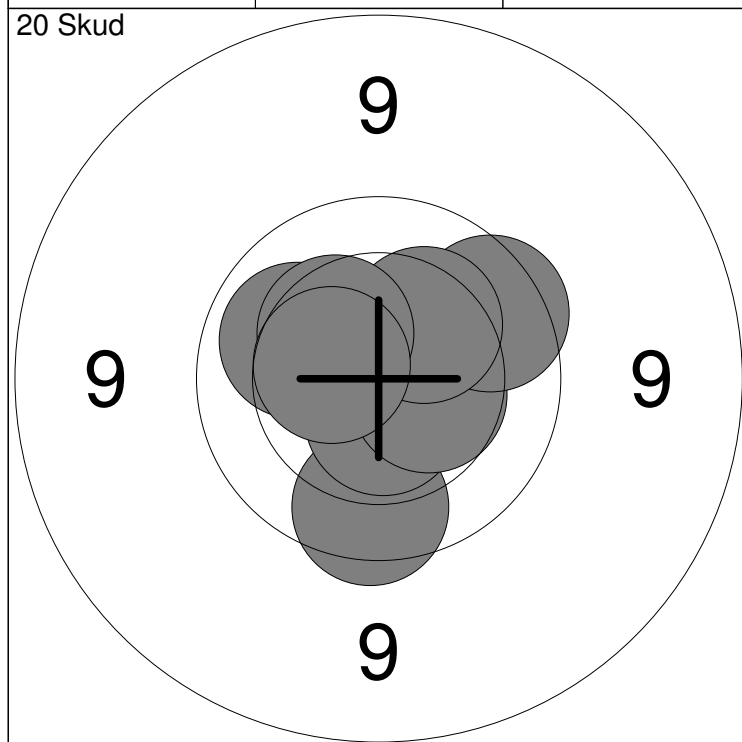

1: 10.6x →	6: 10.4 →	Serie	98
2: 10.3 ↗	7: 9.8 →		
3: 9.8 ↘	8: 10.3 ↗	Total	98
4: 10.6x ↘	9: 10.3 ↗		
5: 10.1 ↗	10: 10.5 ←		

11: 10.5x ↗	16: 10.2 ←	Serie	99
12: 10.2 ↗	17: 10.3 ↘		
13: 10.2 ↗	18: 10.8x ←	Total	197
14: 10.4 ↘	19: 9.9 ↘		
15: 10.3 ←	20: 10.1 →		

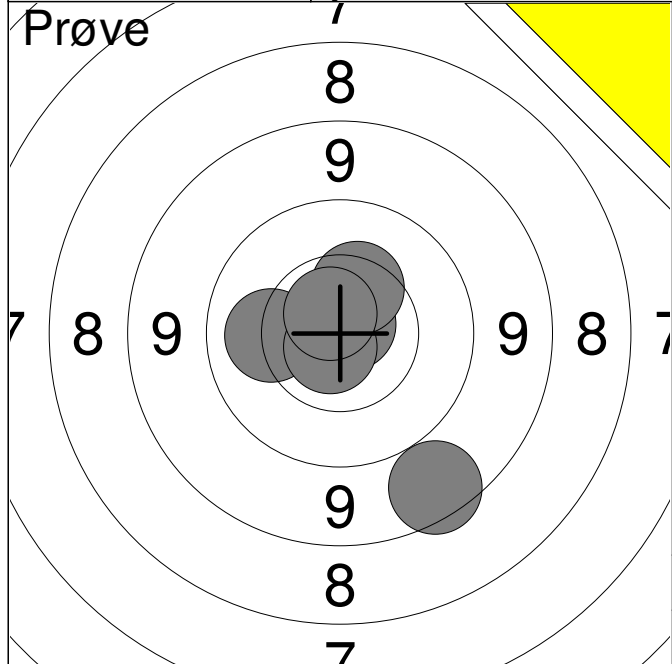

1:	8.7	↘
2:	10.2	←
3:	10.8x	↗
4:	10.4	↗
5:	10.8x	↘
6:	10.7x	↗
<b>Serie</b>		<b>58.0</b>
<b>Total</b>		<b>0.0</b>

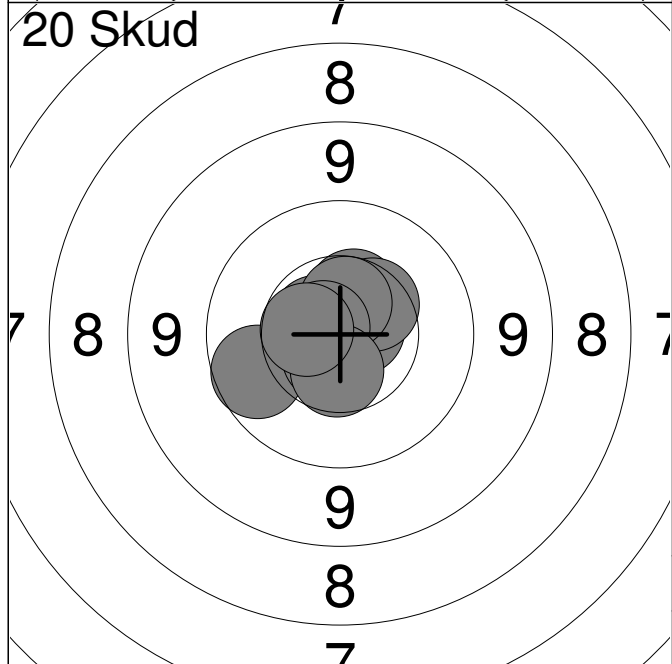

1:	10.5	↗
2:	10.7x	→
3:	9.9	←
4:	10.7x	↘
5:	10.7x	↖
6:	10.4	↗
7:	10.6x	↗
8:	10.7x	←
9:	10.5	↘
10:	10.6	←
<b>Serie</b>		<b>99.0</b>
<b>Total</b>		<b>99.0</b>

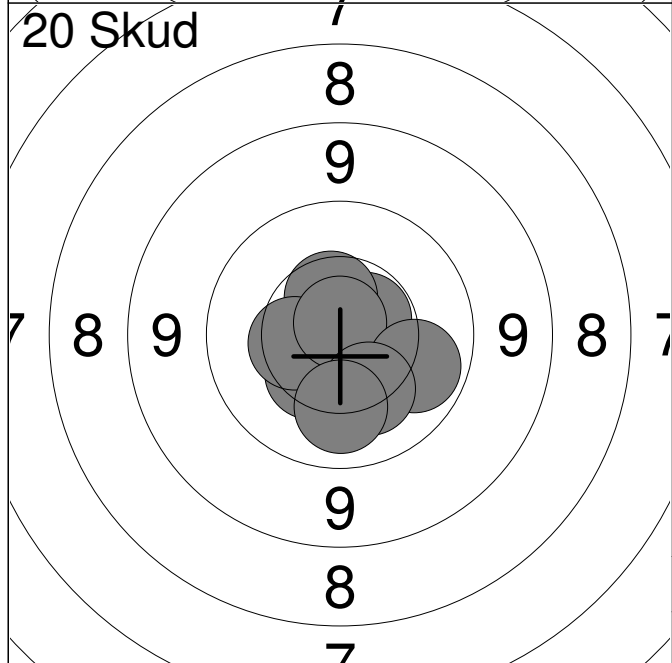

11:	10.4	↘
12:	10.6x	↗
13:	10.7x	↘
14:	10.5	↗
15:	10.3	↘
16:	10.4	←
17:	10.8x	↗
18:	10.0	→
19:	10.2	↘
20:	10.1	↘
<b>Serie</b>		<b>100.0</b>
<b>Total</b>		<b>199.0</b>

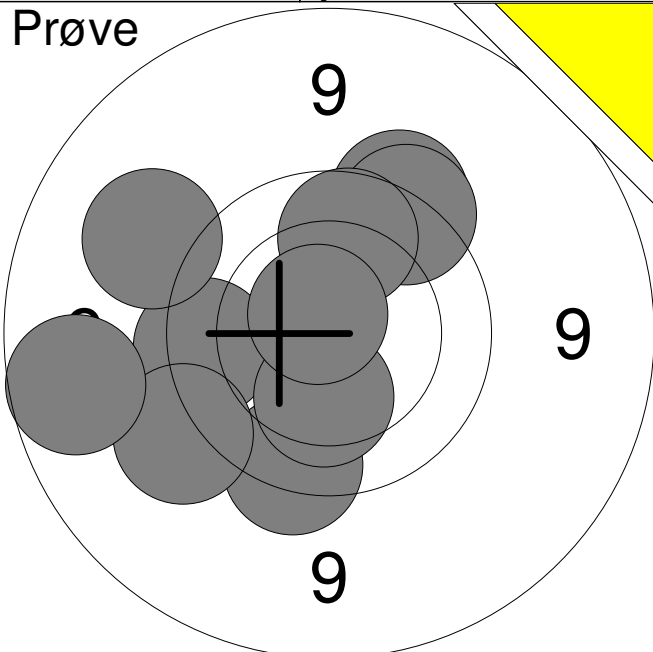
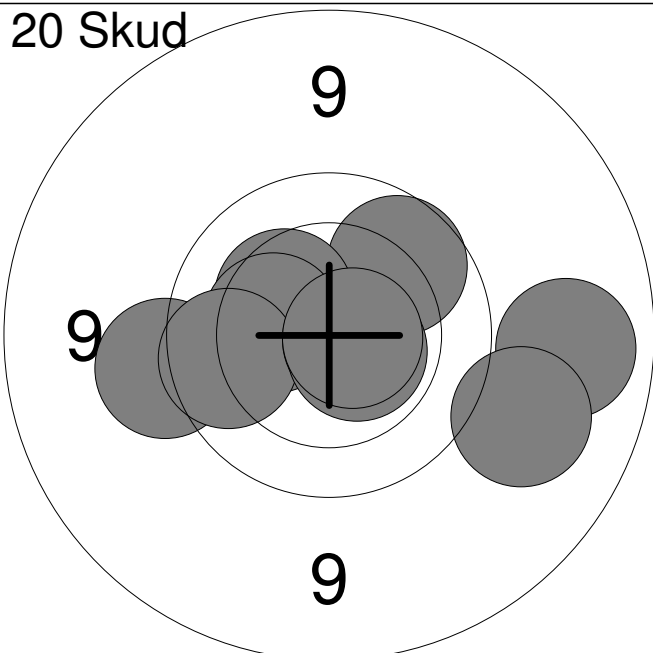
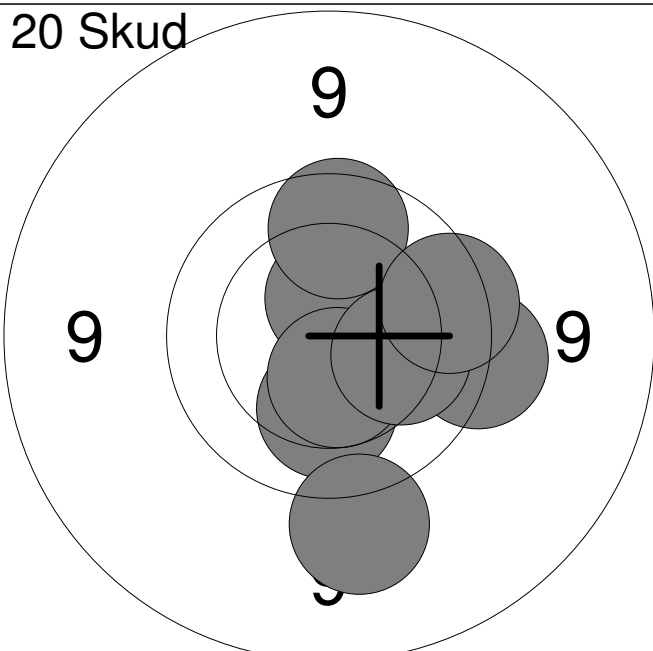
Hold	Skive	Michael Guldbæk Larsen	
17	8	15m	Mou & Omegns Skf. ÅK3
11.02.2015	Jyllandsstævne 2015	Aalborg Skyttekreds	
<b>Prøve</b> 	1:	9.7	↓
	2:	9.7	←
	3:	9.3	↗
	4:	9.4	↙
	5:	8.9	←
	6:	10.3	↓
	7:	9.6	↗
	8:	9.6	↗
	9:	9.9	↑
	10:	10.7x	↖
	<b>Serie</b>		<b>91.0</b>
<b>Total</b>		<b>0.0</b>	
<b>20 Skud</b> 	1:	9.9	↗
	2:	10.3	↗
	3:	9.5	←
	4:	10.3	←
	5:	9.9	←
	6:	9.1	→
	7:	10.7x	→
	8:	9.2	→
	9:	10.6x	↘
	10:	10.7x	→
<b>Serie</b>		<b>95.0</b>	
<b>Total</b>		<b>95.0</b>	
<b>20 Skud</b> 	11:	9.9	→
	12:	9.6	→
	13:	10.1	→
	14:	10.2	↓
	15:	10.5x	↑
	16:	9.9	↑
	17:	10.5x	↓
	18:	10.2	→
	19:	9.8	→
	20:	9.3	↓
<b>Serie</b>		<b>95.0</b>	
<b>Total</b>		<b>190.0</b>	

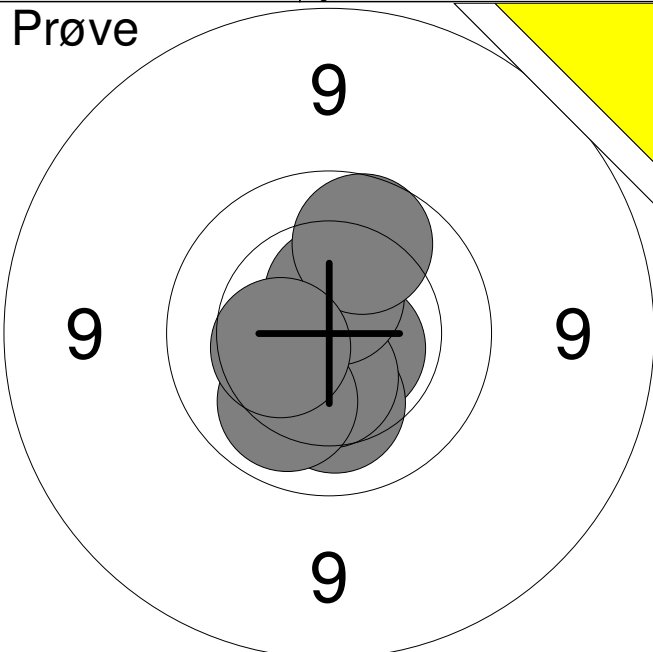
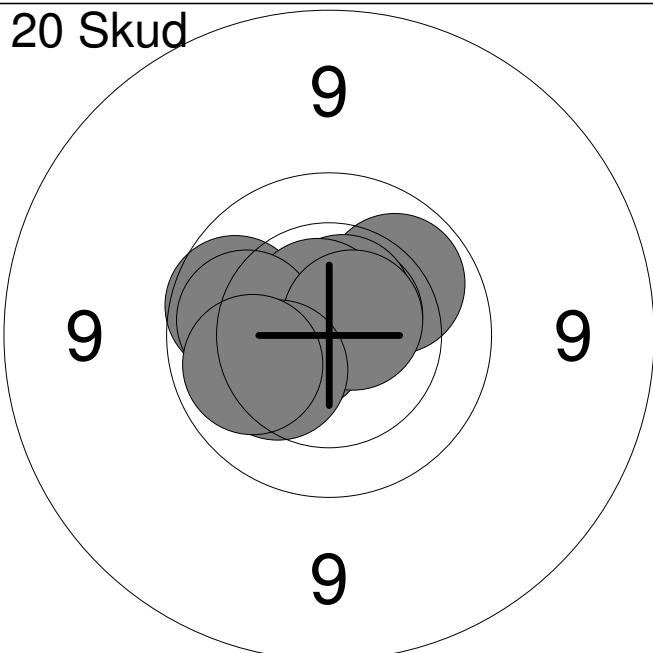
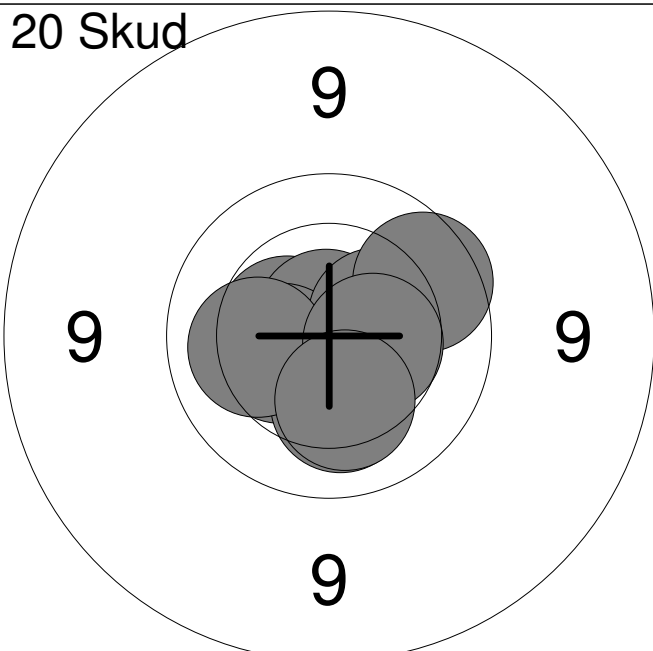
Hold	Skive	Christian Frost		
17	9	Aalborg Skyttekreds		MÅ1
15m	Jyllandsstævne 2015		Aalborg Skyttekreds	
11.02.2015	Jyllandsstævne 2015		Aalborg Skyttekreds	
Prøve		1:	10.6x	→
		2:	10.2	↓
		3:	10.5	↓
		4:	10.1	↙
		5:	10.5x	↑
		6:	9.9	↑
		7:	10.4	←
		<b>Serie</b>	<b>69.0</b>	
		<b>Total</b>	<b>0.0</b>	
20 Skud		1:	9.9	←
		2:	10.0	↗
		3:	10.6x	↗
		4:	10.6x	↑
		5:	10.6x	←
		6:	10.6x	↑
		7:	10.0	←
		8:	10.6x	↗
		9:	10.3	↙
		10:	10.1	←
		<b>Serie</b>	<b>99.0</b>	
		<b>Total</b>	<b>99.0</b>	
20 Skud		11:	10.7x	↖
		12:	10.5	←
		13:	10.8x	↑
		14:	10.4	←
		15:	10.4	↗
		16:	9.9	↗
		17:	10.2	↓
		18:	10.2	←
		19:	10.5	→
		20:	10.2	↓
		<b>Serie</b>	<b>99.0</b>	
		<b>Total</b>	<b>198.0</b>	

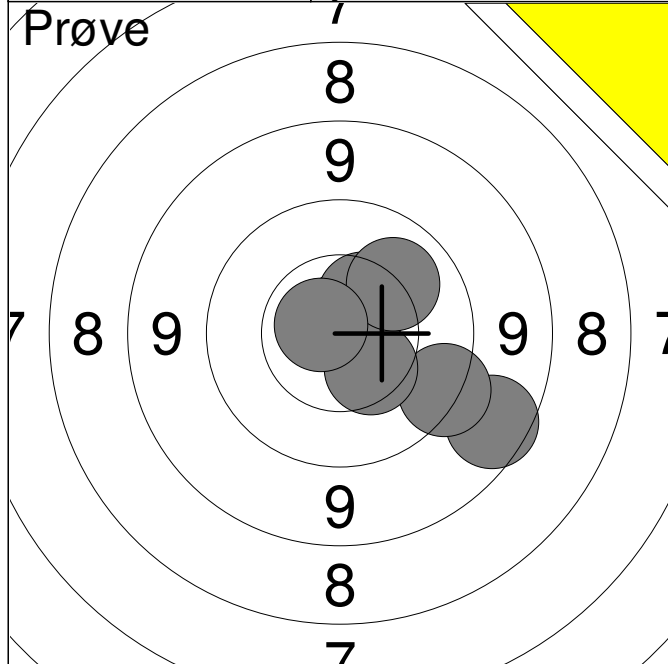

1:	8.8	↘
2:	10.5	↗
3:	9.5	↘
4:	10.8x	↗
5:	10.5	↗
6:	10.4	↘
7:	10.1	↗
8:	10.7x	↖
<b>Serie</b>		<b>77.0</b>
<b>Total</b>		<b>0.0</b>

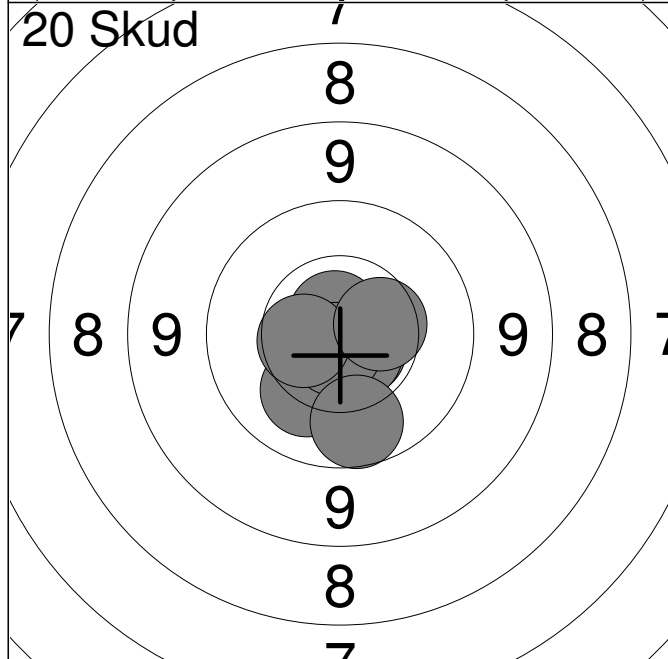

1:	10.7x	↘
2:	10.3	↓
3:	10.2	↓
4:	10.8x	←
5:	10.7x	↘
6:	10.7x	↗
7:	10.8x	↓
8:	9.9	↓
9:	10.5	←
10:	10.5	→
<b>Serie</b>		<b>99.0</b>
<b>Total</b>		<b>99.0</b>

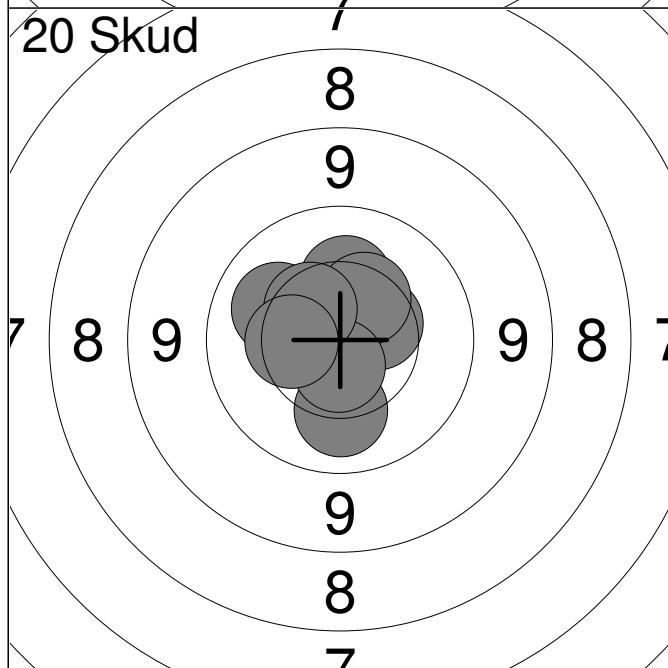

11:	10.5	↗
12:	10.4	↗
13:	10.7x	↗
14:	10.3	↑
15:	10.2	↗
16:	10.1	↓
17:	10.4	↗
18:	10.7x	↓
19:	10.5	↗
20:	10.4	←
<b>Serie</b>		<b>100.0</b>
<b>Total</b>		<b>199.0</b>

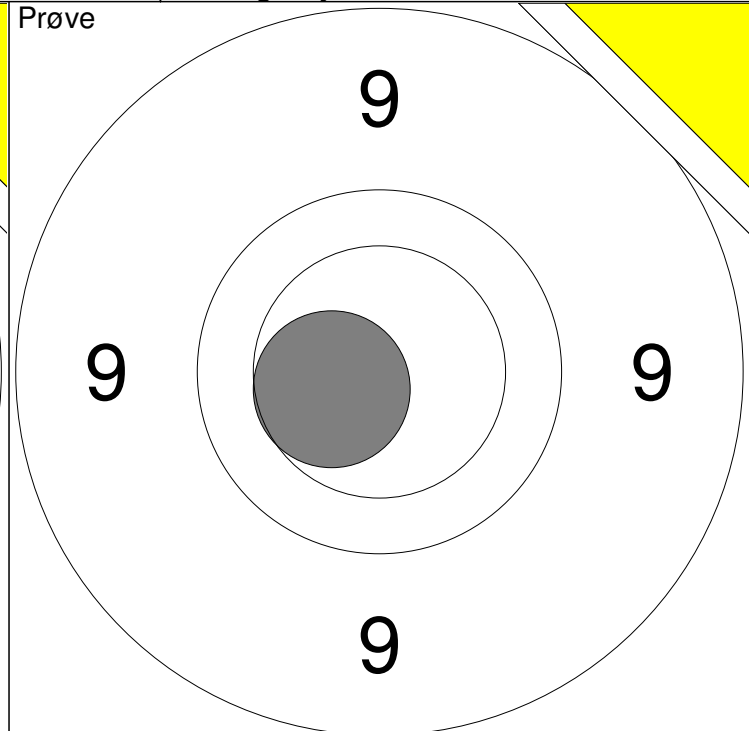
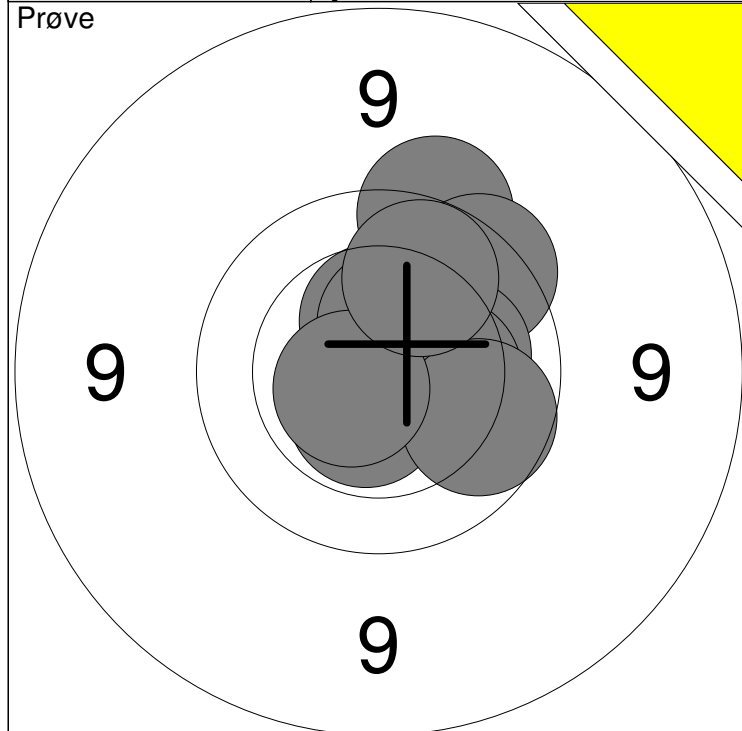

1: 9.6 ↑	6: 10.5 ↑	Serie	97
2: 9.7 ↗	7: 10.3 →		
3: 10.5 ↑	8: 9.9 ↘	Total	0
4: 10.2 →	9: 10.6x ↙		
5: 10.6x ↓	10: 10.0 ↑		

11: 10.5 ←		Serie	10
		Total	0

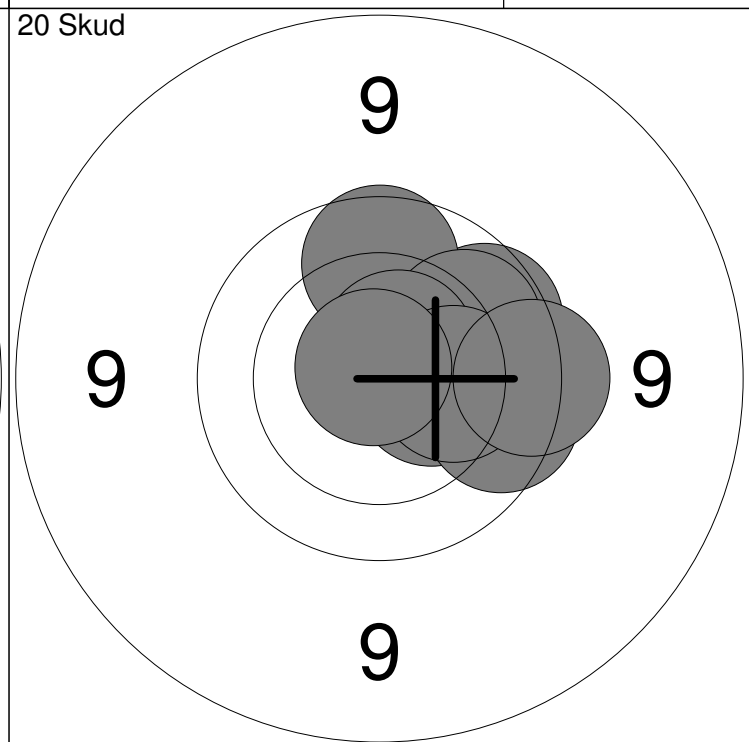
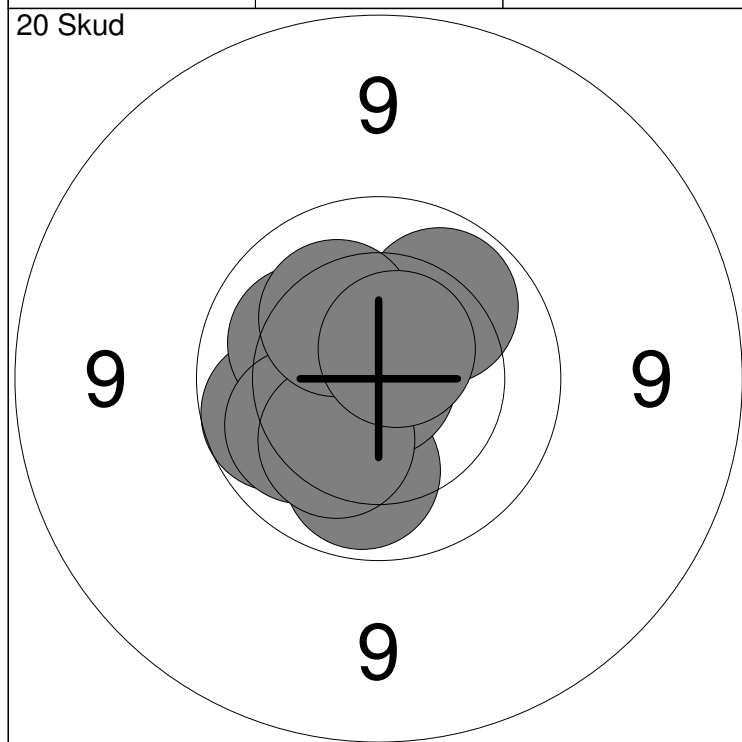

1: 10.6x ↑	6: 10.9x ↓	Serie	99
2: 9.9 ←	7: 10.0 ↗		
3: 10.2 ↖	8: 10.2 ↓	Total	99
4: 10.1 ↙	9: 10.2 ↗		
5: 10.0 ↓	10: 10.6x ↗		

11: 10.4 →	16: 10.0 ↗	Serie	96
12: 10.2 ↗	17: 10.6x ↗		
13: 9.9 ↗	18: 10.2 →	Total	195
14: 9.9 ↑	19: 10.8x ↖		
15: 9.8 →	20: 9.7 →		

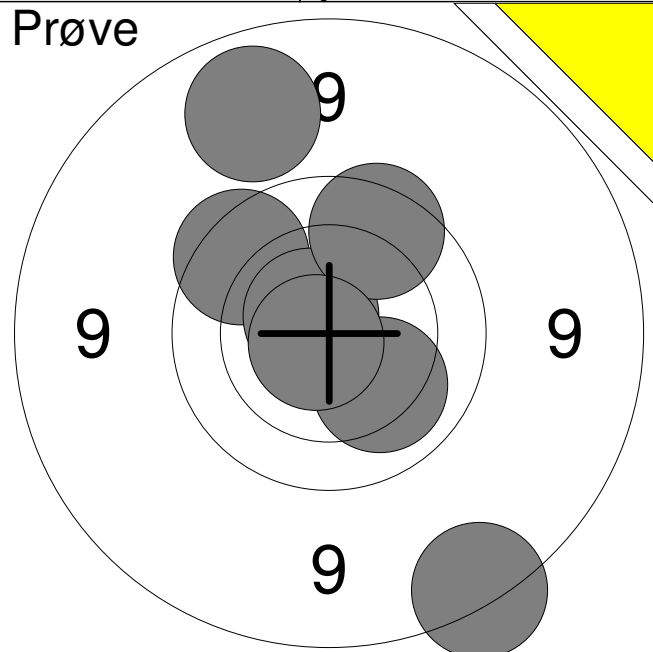
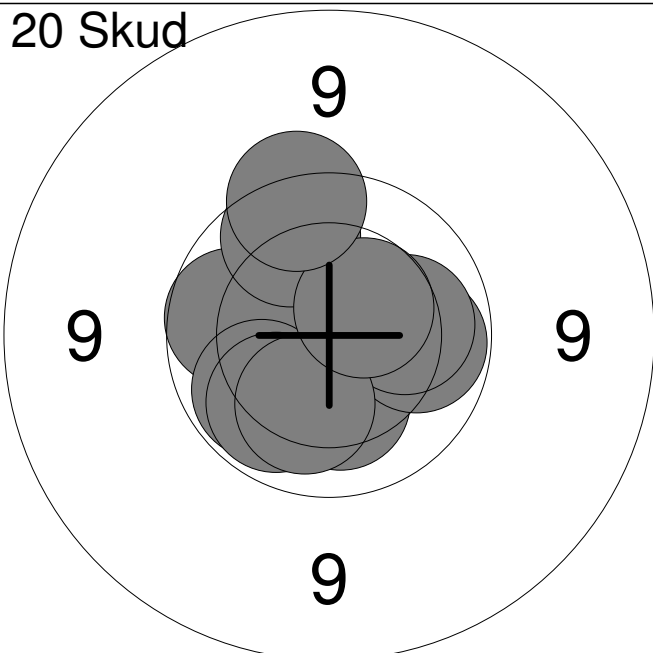
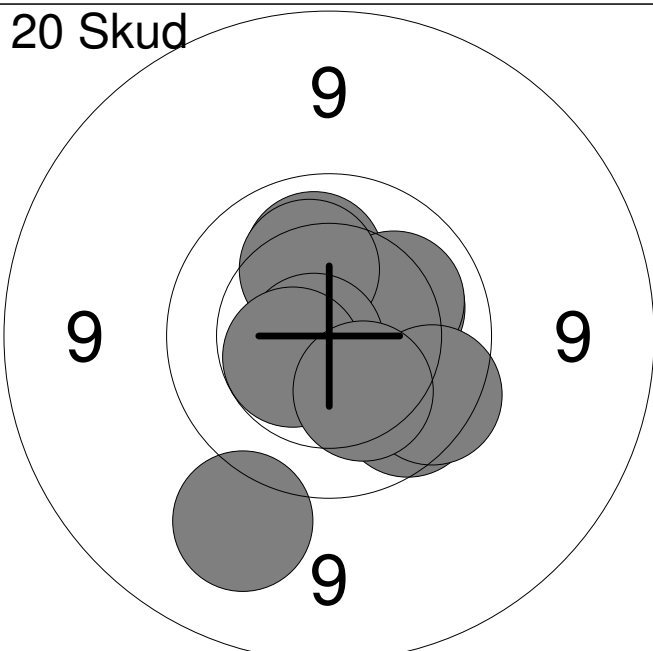

Hold	Skive	Jens Justenlund	
17	12	15m	Åbybro Skytteforening
11.02.2015	Jyllandsstævne 2015	Aalborg Skyttekreds	
<b>Prøve</b> 	1:	8.7	↘
	2:	10.1	↘
	3:	9.8	↗
	4:	9.0	↗
	5:	10.7x	↗
	6:	9.8	↗
	7:	10.8x	↙
	<b>Serie</b>	<b>65.0</b>	
	<b>Total</b>	<b>0.0</b>	
<b>20 Skud</b> 	1:	10.2	↘
	2:	9.9	←
	3:	10.0	↙
	4:	10.0	→
	5:	10.1	→
	6:	10.0	↙
	7:	9.9	↗
	8:	10.2	↘
	9:	10.5	↗
	10:	9.7	↗
	<b>Serie</b>	<b>97.0</b>	
	<b>Total</b>	<b>97.0</b>	
<b>20 Skud</b> 	11:	10.1	↗
	12:	10.2	→
	13:	9.3	↘
	14:	10.2	→
	15:	9.9	↘
	16:	10.2	↗
	17:	10.8x	↙
	18:	9.8	↘
	19:	10.5x	↙
	20:	10.2	↘
	<b>Serie</b>	<b>97.0</b>	
	<b>Total</b>	<b>194.0</b>	

Hold	Skive	Mathias Haugaard Mikkelsen	
18	1	Hjørring Skytteforening	J1
15m		Jyllandsstævne 2015	Aalborg Skyttekreds
11.02.2015			
Prøve		1: 10.3 ←	
		2: 9.9 ↖	
		3: 10.3 ↘	
		4: 9.9 ↖	
		5: 10.5x ↗	
		7: 10.3 ↘	
		8: 9.7 ↘	
		9: 10.1 ↗	
		10: 10.8x ↘	
		<b>Serie</b>	<b>87.0</b>
		<b>Total</b>	<b>0.0</b>
20 Skud		1: 10.0 ↗	
		2: 10.1 ↘	
		3: 9.8 ↖	
		4: 10.7x ↘	
		5: 10.1 ↘	
		6: 10.5x ↘	
		7: 9.6 ↗	
		8: 10.6x ↘	
		9: 10.4 ↗	
		10: 10.7x ↗	
		<b>Serie</b>	<b>98.0</b>
		<b>Total</b>	<b>98.0</b>
20 Skud		11: 9.6 ↖	
		12: 10.4 ↗	
		13: 10.2 ↗	
		14: 10.3 ↖	
		15: 10.1 ↖	
		16: 10.6x ↗	
		17: 9.6 ↗	
		18: 9.9 ↖	
		19: 10.8x ↘	
		20: 10.4 ↗	
		<b>Serie</b>	<b>97.0</b>
		<b>Total</b>	<b>195.0</b>

Hold <b>18</b>	Skive <b>2</b>	<b>Jasmin Kristensen</b>	
-------------------	-------------------	--------------------------	--

15m	Mou & Omegns Skf.	BK2	
-----	-------------------	-----	--

11.02.2015	Jyllandsstævne 2015	Aalborg Skyttekreds	
------------	---------------------	---------------------	--

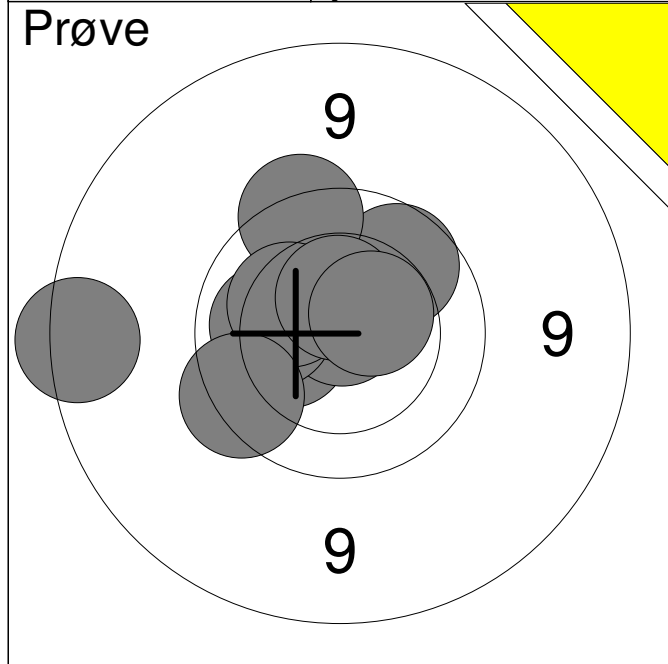

1:	9.9	↗
2:	10.3	←
3:	10.8x	↑
4:	8.8	←
5:	9.7	↑
6:	10.1	←
7:	10.2	↗
8:	10.5x	↑
9:	9.7	↙
10:	10.5x	↗
<b>Serie</b>		<b>95.0</b>
<b>Total</b>		<b>0.0</b>

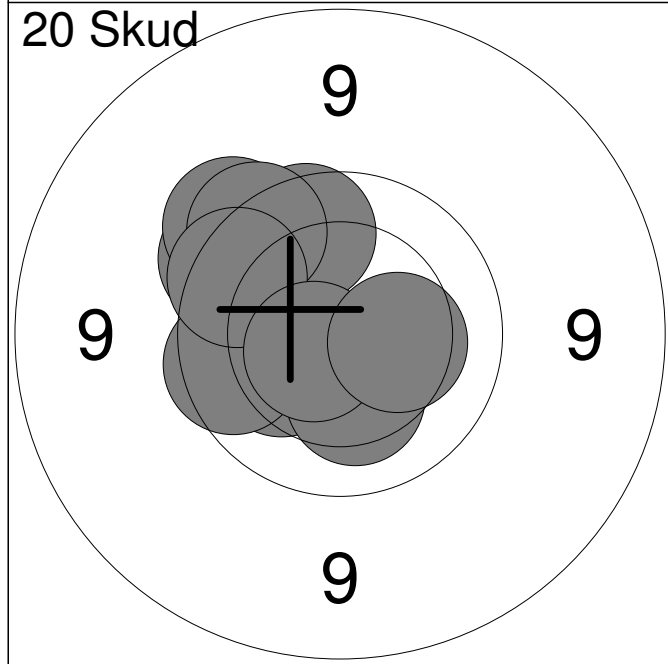

1:	9.7	↗
2:	9.6	↗
3:	10.2	↙
4:	9.8	←
5:	9.9	↑
6:	9.7	↗
7:	9.8	↗
8:	10.3	↓
9:	10.6x	↙
10:	10.3	→
<b>Serie</b>		<b>94.0</b>
<b>Total</b>		<b>94.0</b>

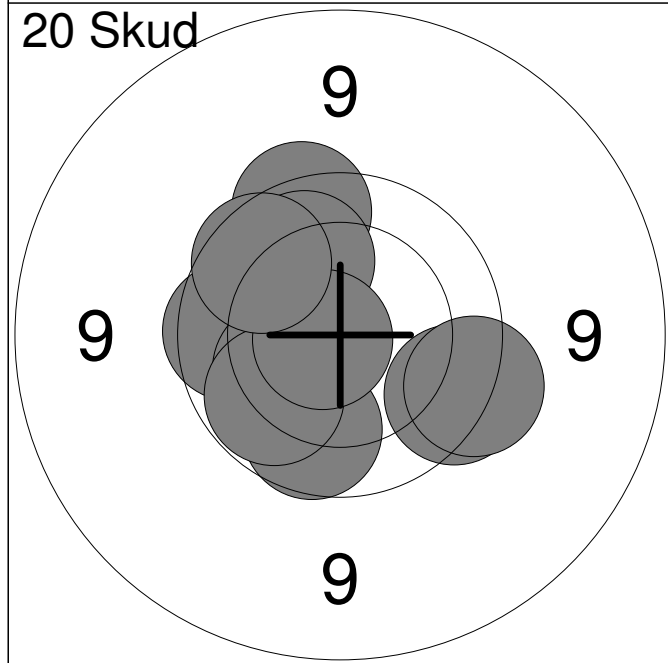

11:	9.9	↓
12:	9.9	←
13:	9.7	↘
14:	10.2	↙
15:	9.6	↘
16:	9.7	↑
17:	10.1	↗
18:	10.0	↙
19:	10.8x	↙
20:	9.9	↗
<b>Serie</b>		<b>94.0</b>
<b>Total</b>		<b>188.0</b>

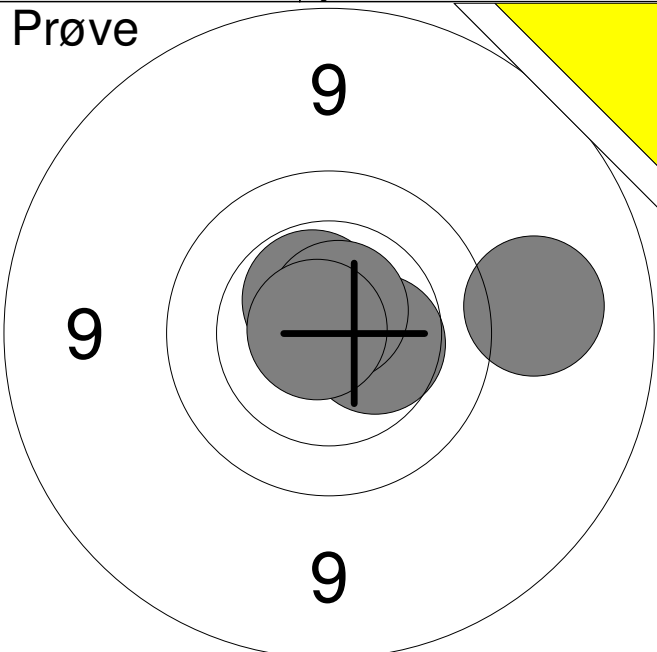
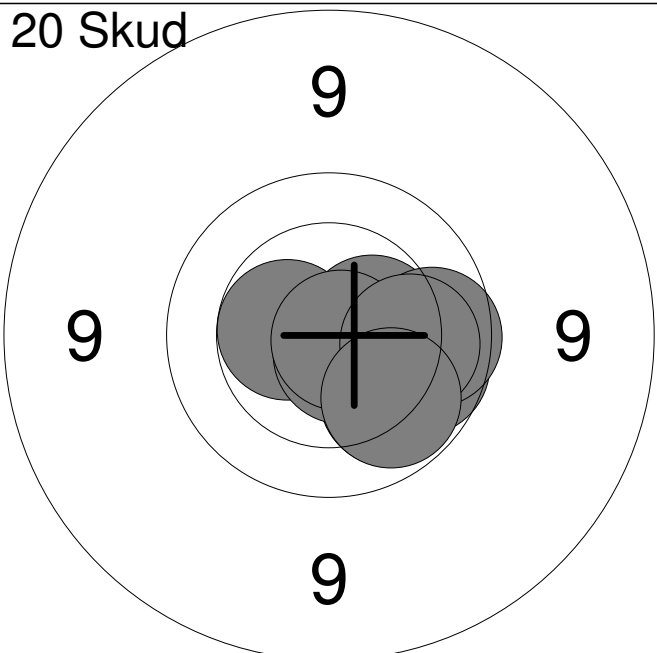
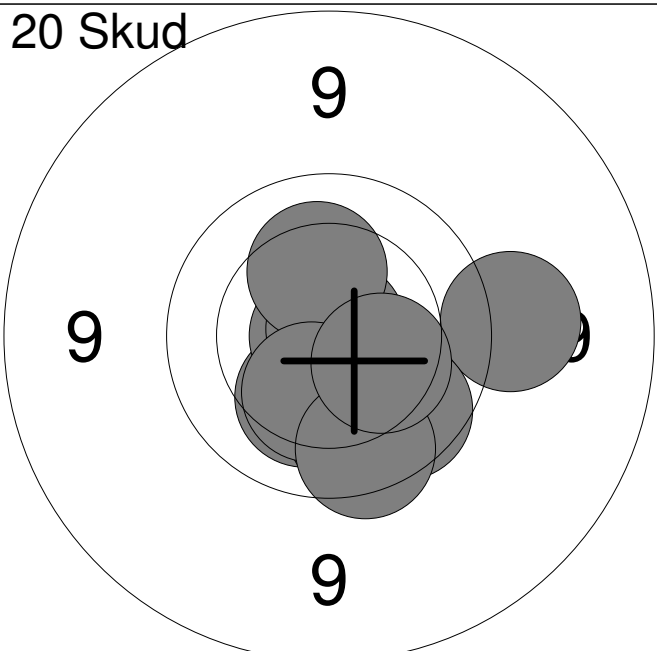
Hold	Skive	Mathias Meulengracht	
18	3	Mou & Omegns Skf.	J2
15m	Jyllandsstævne 2015		Aalborg Skyttekreds
11.02.2015			
Prøve		1: 9.2 →	
		2: 10.5x ↗	
		3: 10.4 →	
		4: 10.7x ↗	
		5: 10.8x ↖	
		<b>Serie</b>	<b>49.0</b>
		<b>Total</b>	<b>0.0</b>
20 Skud		1: 10.5 →	
		2: 9.9 →	
		3: 10.5x ←	
		4: 10.0 ↘	
		5: 10.7x ↘	
		6: 10.2 →	
		7: 10.8x →	
		8: 9.9 →	
		9: 10.1 →	
		10: 10.0 ↘	
		<b>Serie</b>	<b>98.0</b>
		<b>Total</b>	<b>98.0</b>
20 Skud		11: 10.2 ↘	
		12: 10.8x ←	
		13: 10.8x ↗	
		14: 9.9 ↘	
		15: 10.2 ↗	
		16: 9.4 →	
		17: 10.3 ↘	
		18: 9.9 ↘	
		19: 9.8 ↘	
		20: 10.3 ↘	
		<b>Serie</b>	<b>96.0</b>
		<b>Total</b>	<b>194.0</b>

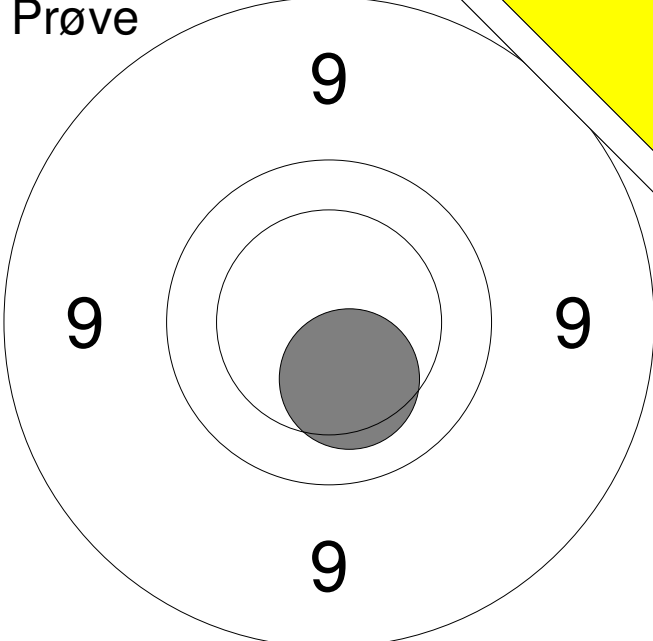
<p><b>Prøve</b></p> 	<p><b>1: 10.3</b> ↓</p>				
<table style="width:100%; border-collapse: collapse;"> <tr> <td style="width:50%;"><b>Serie</b></td> <td style="text-align: right;"><b>10.0</b></td> </tr> <tr> <td><b>Total</b></td> <td style="text-align: right;"><b>0.0</b></td> </tr> </table>		<b>Serie</b>	<b>10.0</b>	<b>Total</b>	<b>0.0</b>
<b>Serie</b>	<b>10.0</b>				
<b>Total</b>	<b>0.0</b>				

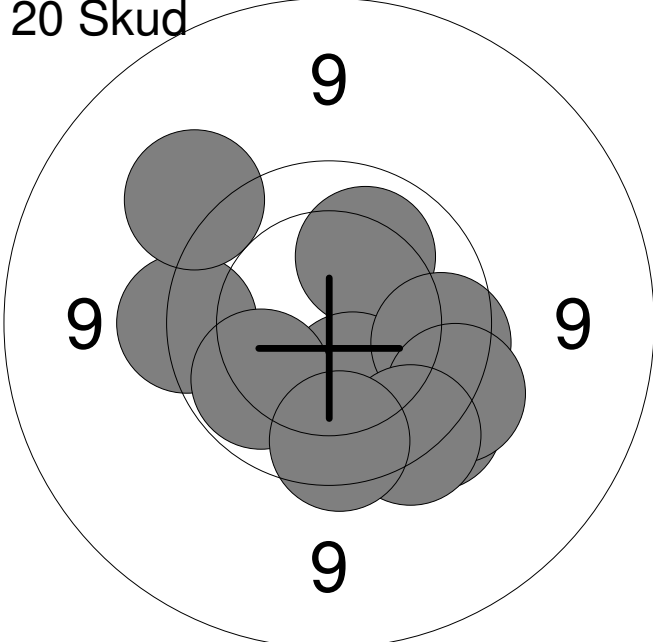
<p><b>20 Skud</b></p> 	<p>1: 10.1 ↗                  2: 10.3 ↓                  3: 9.6 ↓                  4: 9.8 →                  5: 9.6 ↓                  6: 9.6 ←                  7: 9.7 ↓                  8: 9.4 ↗                  9: 10.0 ↙                  10: 9.8 ↓</p>				
<table style="width:100%; border-collapse: collapse;"> <tr> <td style="width:50%;"><b>Serie</b></td> <td style="text-align: right;"><b>93.0</b></td> </tr> <tr> <td><b>Total</b></td> <td style="text-align: right;"><b>93.0</b></td> </tr> </table>		<b>Serie</b>	<b>93.0</b>	<b>Total</b>	<b>93.0</b>
<b>Serie</b>	<b>93.0</b>				
<b>Total</b>	<b>93.0</b>				

<p><b>20 Skud</b></p> 	<p>11: 9.7 →                  12: 10.0 ↓                  13: 9.4 →                  14: 9.5 ↙                  15: 10.6x ↓                  16: 9.9 ↓                  17: 9.6 ↙                  18: 9.8 ↙                  19: 9.9 →                  20: 10.5 ↗</p>				
<table style="width:100%; border-collapse: collapse;"> <tr> <td style="width:50%;"><b>Serie</b></td> <td style="text-align: right;"><b>93.0</b></td> </tr> <tr> <td><b>Total</b></td> <td style="text-align: right;"><b>186.0</b></td> </tr> </table>		<b>Serie</b>	<b>93.0</b>	<b>Total</b>	<b>186.0</b>
<b>Serie</b>	<b>93.0</b>				
<b>Total</b>	<b>186.0</b>				

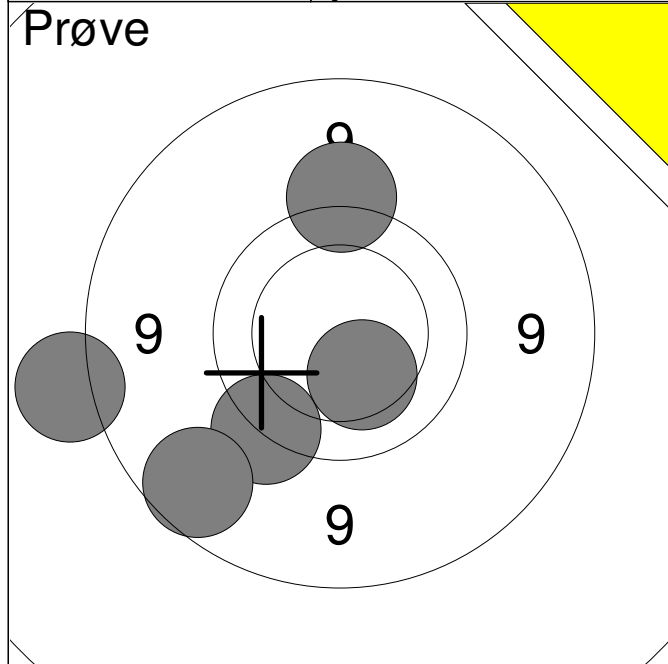

1:	9.6	↙
2:	10.3	↓
3:	8.6	←
4:	8.9	↙
5:	9.4	↑
<b>Serie</b>		<b>44.0</b>
<b>Total</b>		<b>0.0</b>

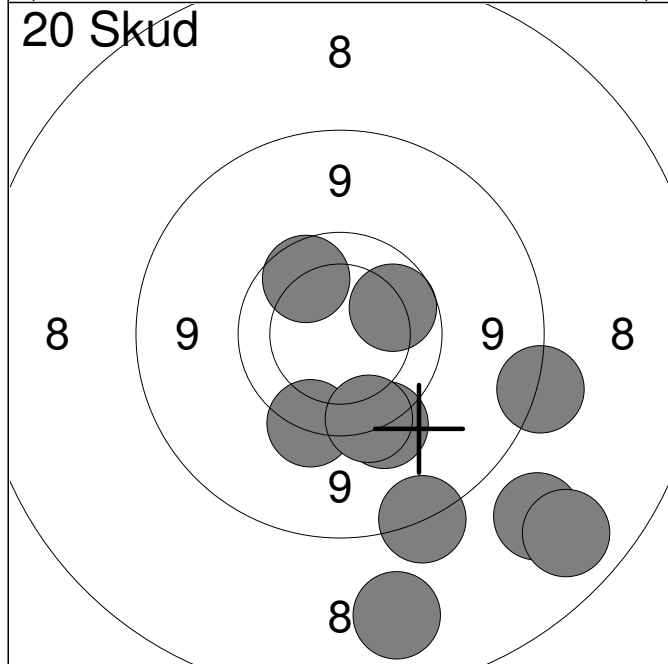

1:	8.3	↘
2:	9.5	↘
3:	9.9	↗
4:	9.6	↘
5:	8.6	→
6:	8.0	↘
7:	8.1	↘
8:	8.7	↘
9:	9.9	→
10:	9.6	↘
<b>Serie</b>		<b>85.0</b>
<b>Total</b>		<b>85.0</b>

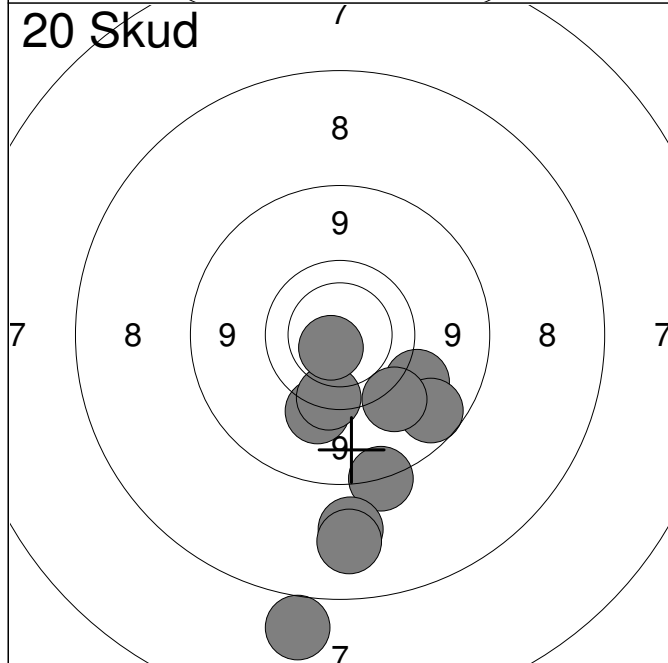

11:	7.4	↓
12:	9.5	↘
13:	8.7	↘
14:	9.7	↘
15:	9.3	↘
16:	8.3	↘
17:	10.6x	↘
18:	8.9	↘
19:	9.4	↘
20:	8.2	↓
<b>Serie</b>		<b>85.0</b>
<b>Total</b>		<b>170.0</b>

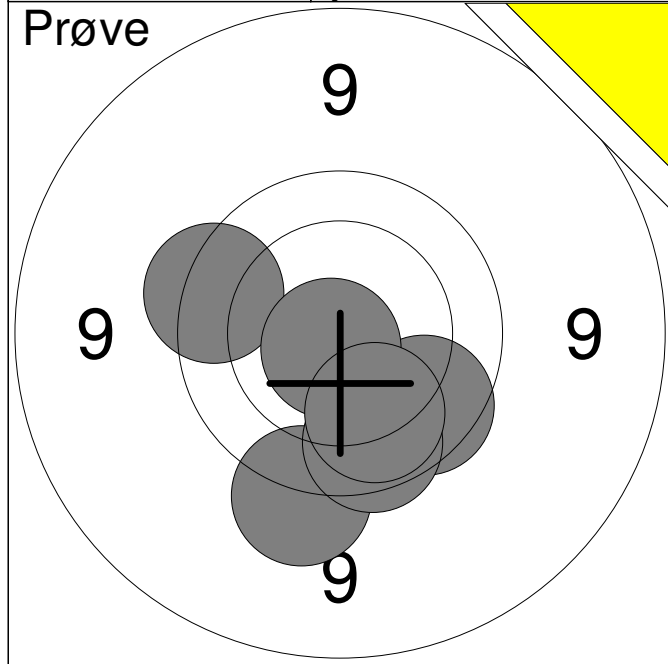

1:	9.7	↖
2:	9.5	↘
3:	9.8	↘
4:	9.8	↘
5:	10.8x	↘
6:	10.0	↘
<b>Serie</b>		<b>56.0</b>
<b>Total</b>		<b>0.0</b>

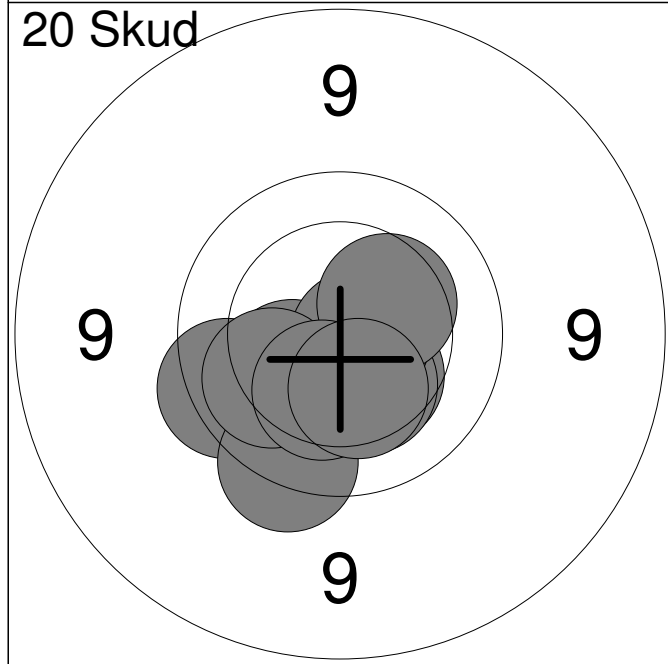

1:	10.4	↘
2:	10.3	↖
3:	10.3	↘
4:	10.7x	→
5:	9.7	↖
6:	10.3	↗
7:	9.7	↘
8:	10.1	↖
9:	10.3	↘
10:	10.3	↘
<b>Serie</b>		<b>98.0</b>
<b>Total</b>		<b>98.0</b>

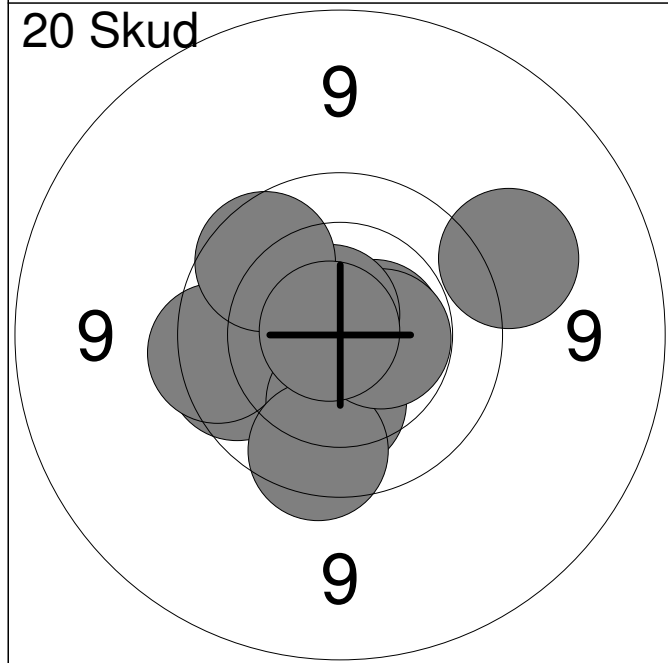

11:	10.6x	→
12:	9.9	↖
13:	9.8	↖
14:	10.2	↘
15:	9.8	↘
16:	10.5x	→
17:	10.7x	↗
18:	9.9	↗
19:	9.4	→
20:	10.8x	↖
<b>Serie</b>		<b>95.0</b>
<b>Total</b>		<b>193.0</b>

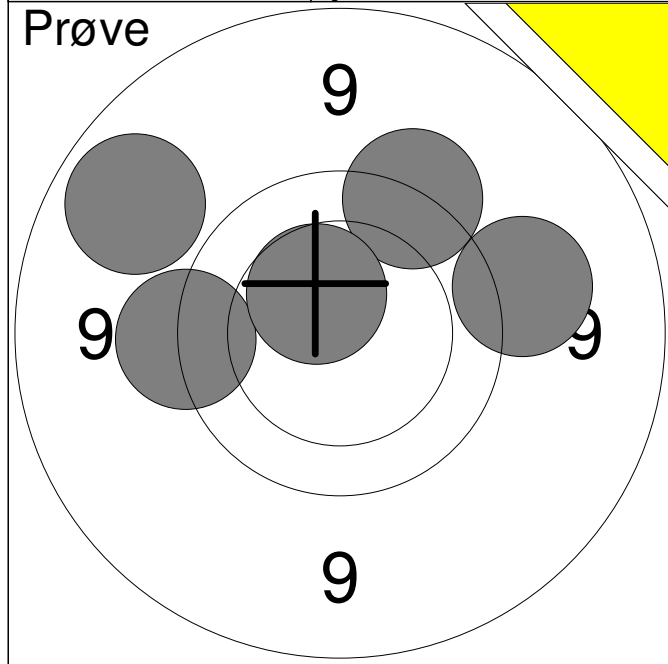

1:	9.6	←
2:	9.0	↗
3:	9.6	↗
4:	9.4	→
5:	10.5	↗
<b>Serie</b>		<b>46.0</b>
<b>Total</b>		<b>0.0</b>

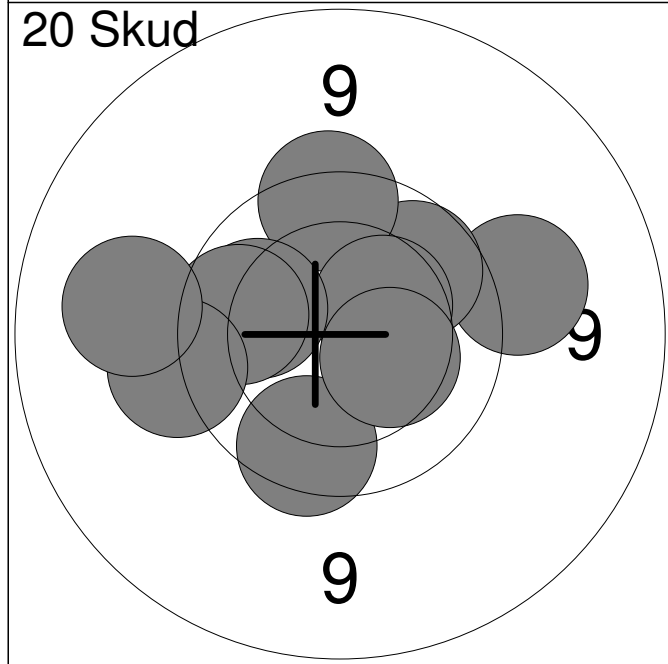

1:	9.4	→
2:	9.9	↗
3:	9.7	↑
4:	10.4	↗
5:	9.8	↓
6:	10.4	↘
7:	10.0	←
8:	9.9	←
9:	9.5	←
10:	9.2	←
<b>Serie</b>		<b>93.0</b>
<b>Total</b>		<b>93.0</b>

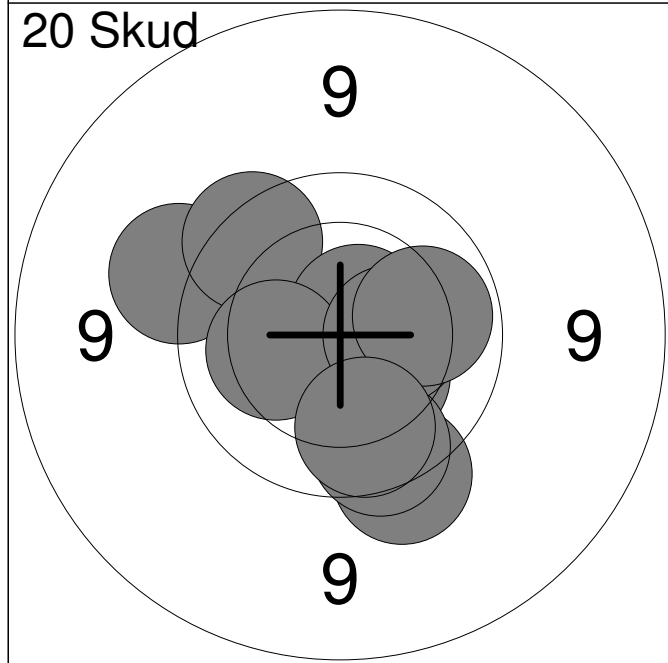

11:	10.3	↘
12:	9.6	↘
13:	9.8	↘
14:	9.5	↗
15:	9.7	↗
16:	10.7x	↗
17:	10.2	←
18:	10.4	→
19:	10.0	→
20:	9.9	↓
<b>Serie</b>		<b>95.0</b>
<b>Total</b>		<b>188.0</b>



Hold	Skive	Pernille Holst Andersen	
18	8	15m	Skf. Kimbreerne MJ1
11.02.2015	Jyllandsstævne 2015	Aalborg Skyttekreds	
Prøve		1: 10.5	↑
		2: 10.2	↑
		3: 9.9	↗
		4: 10.3	↗
		5: 10.1	↗
		6: 10.4	↗
		<b>Serie</b>	<b>59.0</b>
		<b>Total</b>	<b>0.0</b>
20 Skud		1: 10.1	↙
		2: 10.5x	↓
		3: 10.8x	↗
		4: 10.7x	↓
		5: 10.1	↙
		6: 10.5x	←
		7: 10.5x	↗
		8: 10.5x	↗
		9: 10.4	↓
		10: 10.1	↗
		<b>Serie</b>	<b>100.0</b>
		<b>Total</b>	<b>100.0</b>
20 Skud		11: 10.3	↑
		12: 10.9x	↙
		13: 10.7x	↓
		14: 10.8x	↗
		15: 10.5	↓
		16: 10.4	↗
		17: 10.2	↗
		18: 10.2	↑
		19: 10.3	↘
		20: 10.2	↓
		<b>Serie</b>	<b>100.0</b>
		<b>Total</b>	<b>200.0</b>

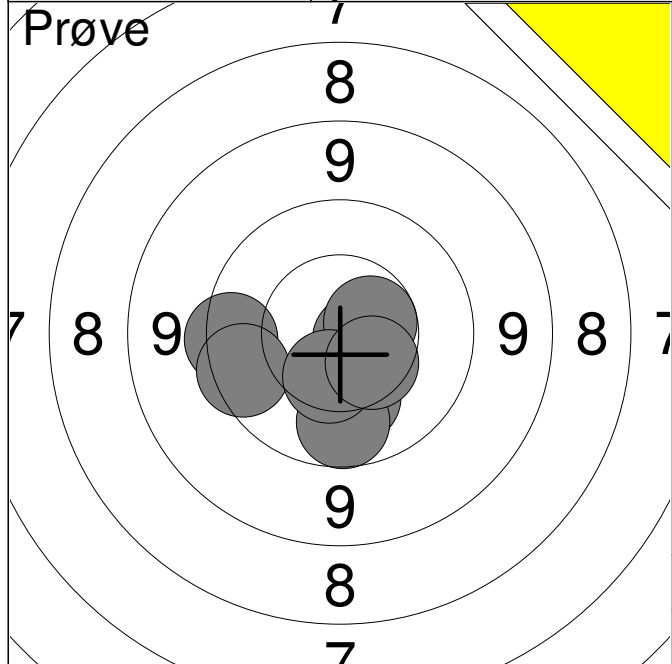

1:	9.7	←
2:	9.7	←
3:	10.7x	→
4:	10.2	↓
5:	10.6	→
6:	9.9	↓
7:	10.4	↓
8:	10.4	↓
<b>Serie</b>		<b>77.0</b>
<b>Total</b>		<b>0.0</b>

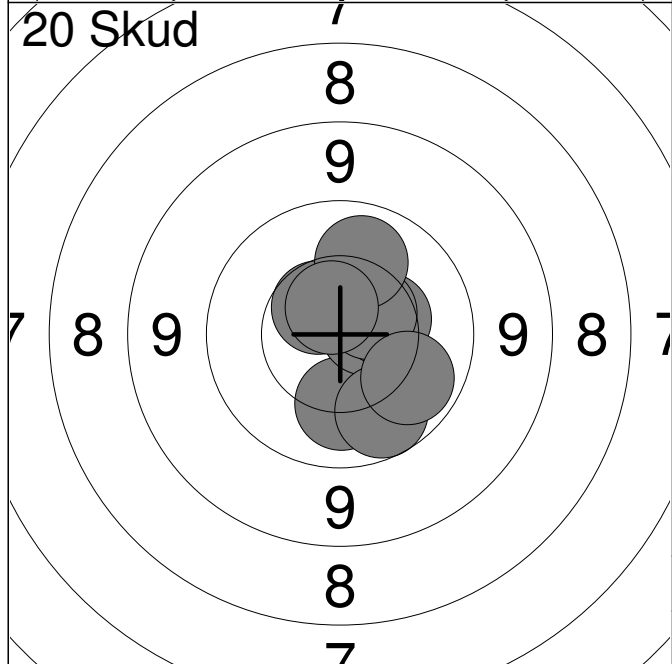

1:	10.1	↓
2:	10.6x	↑
3:	10.5	↑
4:	10.6x	→
5:	10.4	→
6:	9.9	↓
7:	10.5	→
8:	10.1	↑
9:	10.0	→
10:	10.6x	↑
<b>Serie</b>		<b>99.0</b>
<b>Total</b>		<b>99.0</b>

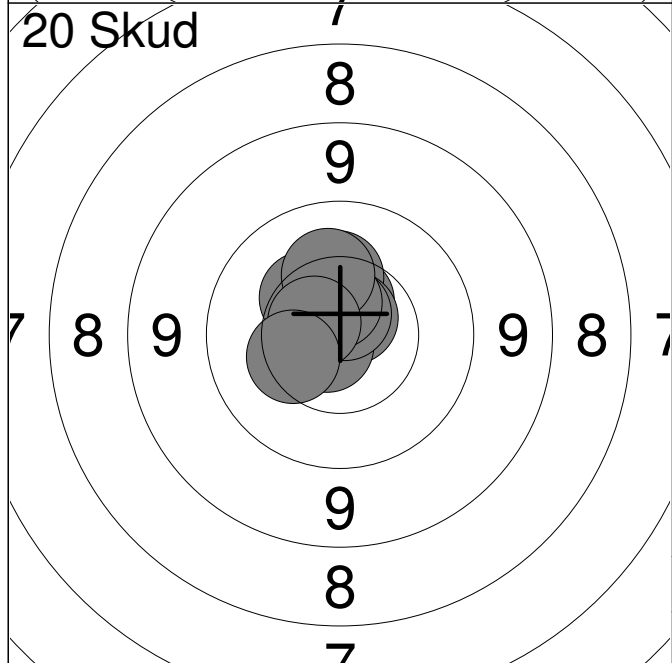

11:	10.5	↑
12:	10.3	↑
13:	10.7x	↗
14:	10.4	↖
15:	10.8x	↙
16:	10.7x	↑
17:	10.6	↑
18:	10.2	↑
19:	10.6x	↖
20:	10.4	↙
<b>Serie</b>		<b>100.0</b>
<b>Total</b>		<b>199.0</b>

Hold <b>18</b>	Skive <b>10</b>	<b>Mikkel Larsen</b>
-------------------	--------------------	----------------------

15m	Vodskov Skytteforening	BK3
-----	------------------------	-----

11.02.2015	Jyllandsstævne 2015	Aalborg Skyttekreds
------------	---------------------	---------------------

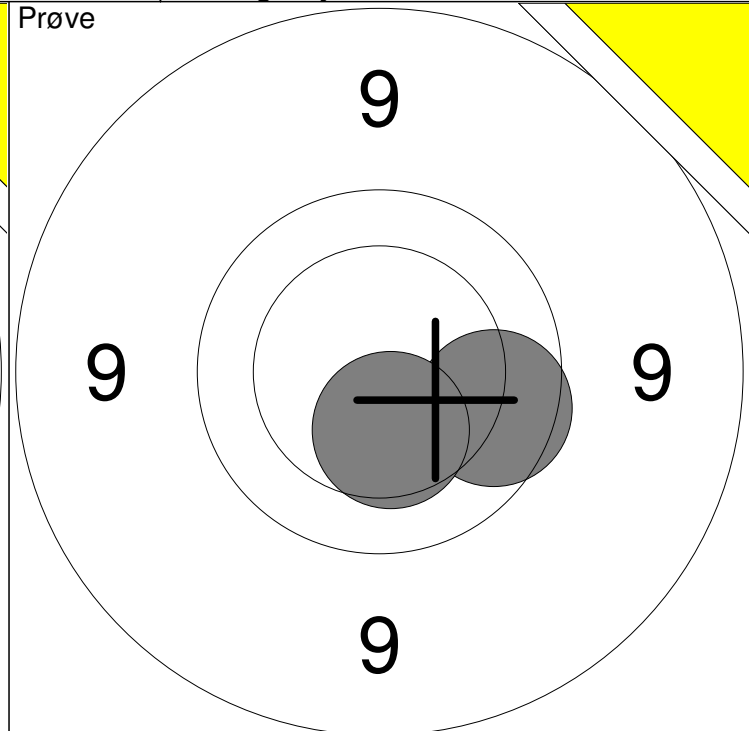
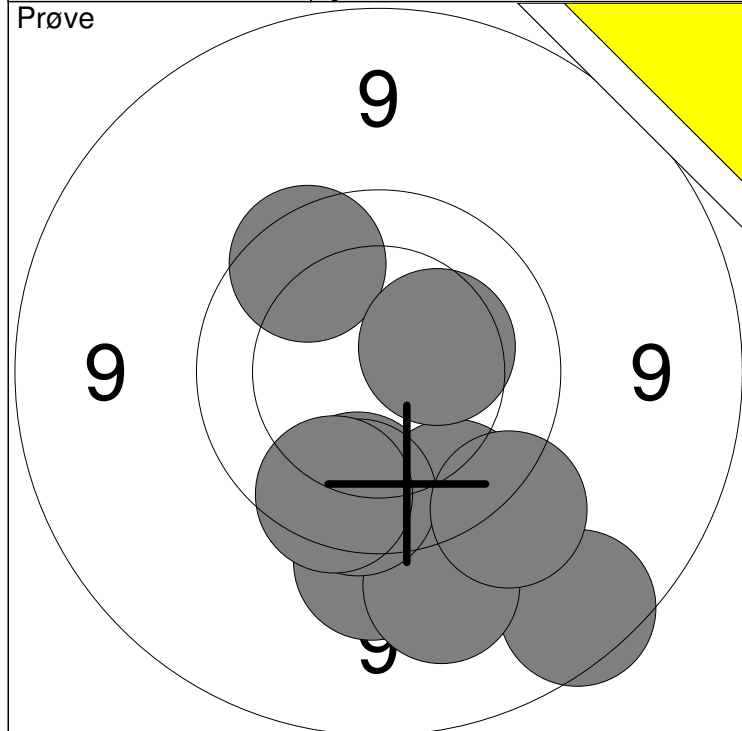

1: 9.9 ↓	6: 9.8 ↗	Serie	90
2: 8.9 ↓	7: 10.3 →		
3: 9.7 ↓	8: 9.8 ↓	Total	0
4: 9.5 ↓	9: 9.5 ↓		
5: 9.3 ↓	10: 9.8 ↓		

11: 9.9 →	Serie	19
12: 10.4 ↓		
	Total	0

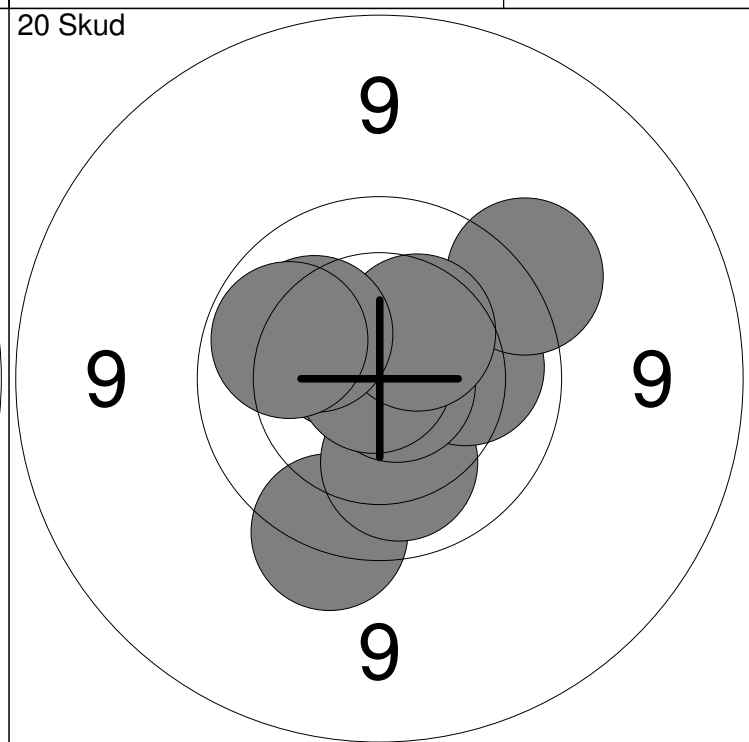
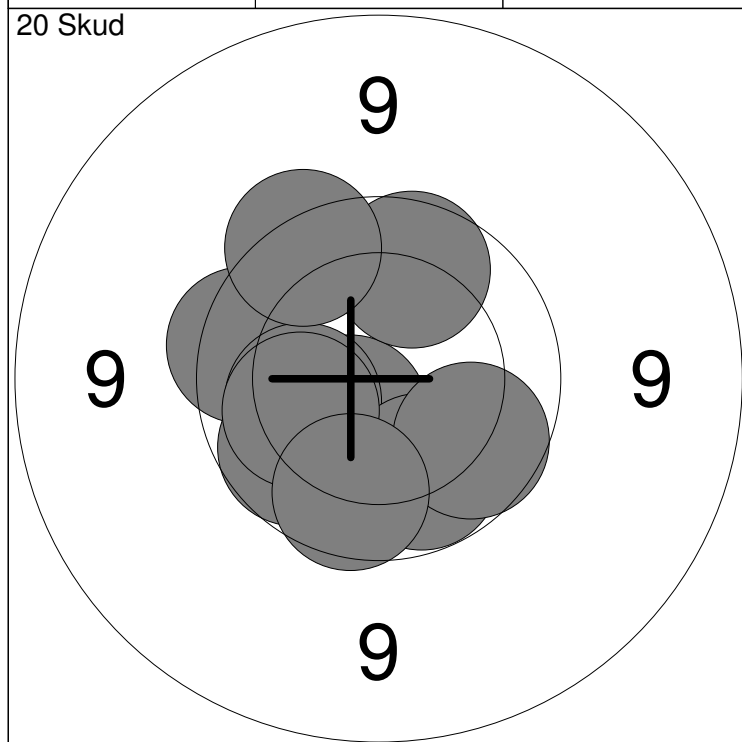

1: 10.5x ↙	6: 10.0 ↓	Serie	94
2: 9.8 ←	7: 9.9 ↓		
3: 10.2 ←	8: 10.1 ←	Total	94
4: 9.9 ↙	9: 9.7 ↗		
5: 9.9 ↑	10: 9.9 ↓		

11: 9.6 ↓	16: 9.5 ↗	Serie	98
12: 10.1 ↓	17: 10.9x ↙		
13: 10.1 →	18: 10.4 ↗	Total	192
14: 10.8x →	19: 10.2 ↙		
15: 10.5x ↗	20: 10.0 ←		

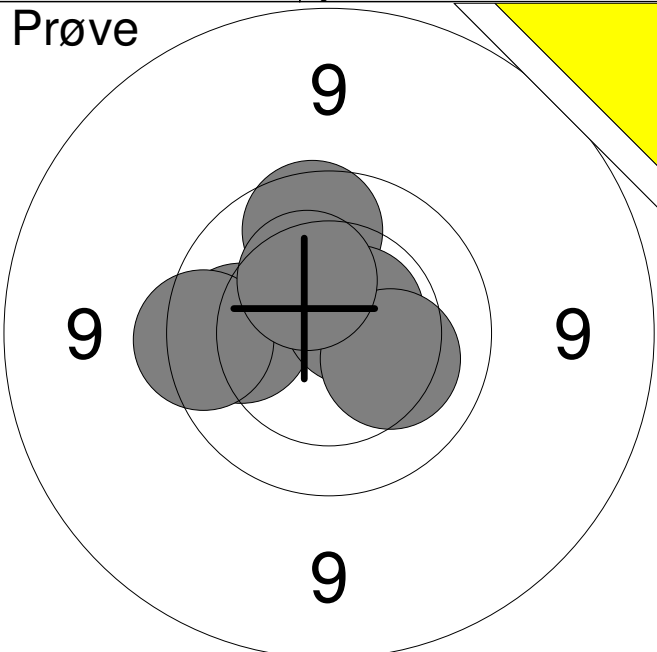
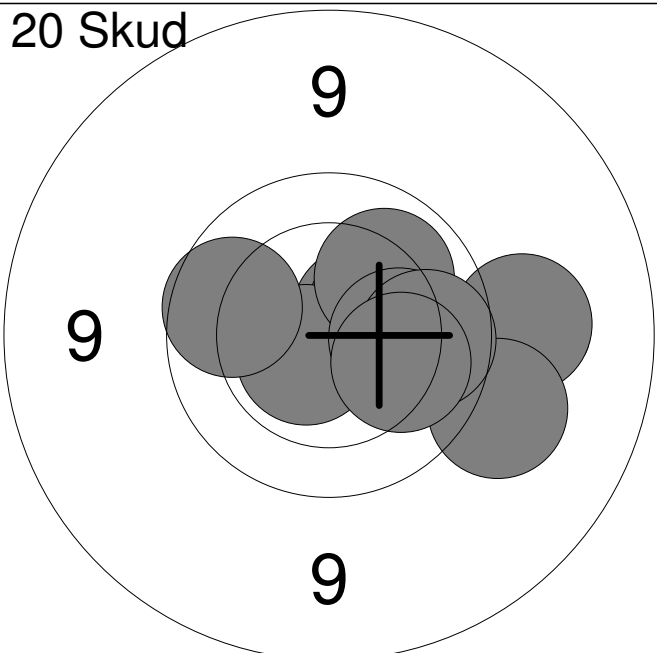
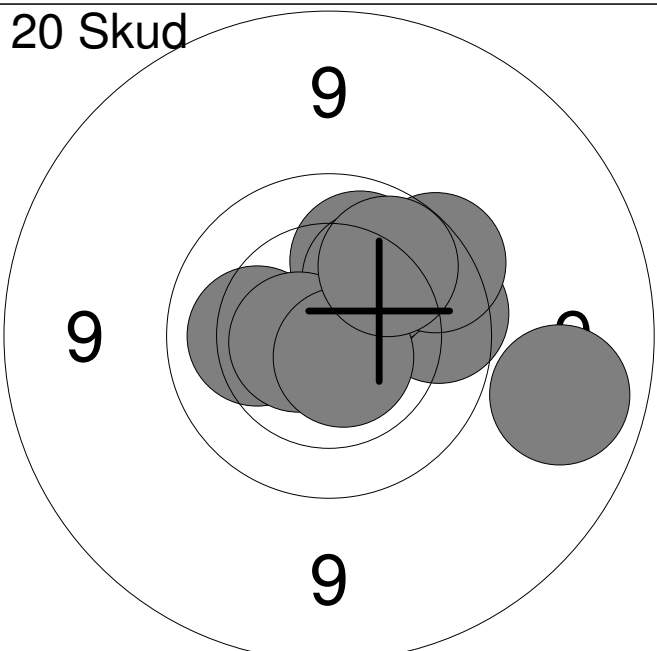
Hold	Skive	Sebastian C. Bonde	
18	11		
15m	Vodskov Skytteforening	BK3	
11.02.2015	Jyllandsstævne 2015	Aalborg Skyttekreds	
Prøve		1: 10.5	↗
		2: 10.0	←
		3: 9.9	↗
		4: 10.6x	↗
		5: 9.7	←
		6: 10.2	↘
		7: 10.3	↗
		<b>Serie</b>	<b>68.0</b>
		<b>Total</b>	<b>0.0</b>
20 Skud		1: 10.5x	↗
		2: 9.3	→
		3: 10.4	↗
		4: 10.6x	↖
		5: 9.9	←
		6: 9.4	↘
		7: 10.1	↗
		8: 10.2	→
		9: 9.9	→
		10: 10.1	↘
		<b>Serie</b>	<b>96.0</b>
		<b>Total</b>	<b>96.0</b>
20 Skud		11: 9.8	→
		12: 10.3	↗
		13: 9.1	→
		14: 10.1	↗
		15: 10.2	↗
		16: 10.2	←
		17: 10.6x	←
		18: 10.7x	↘
		19: 9.7	↗
		20: 10.0	↗
		<b>Serie</b>	<b>97.0</b>
		<b>Total</b>	<b>193.0</b>

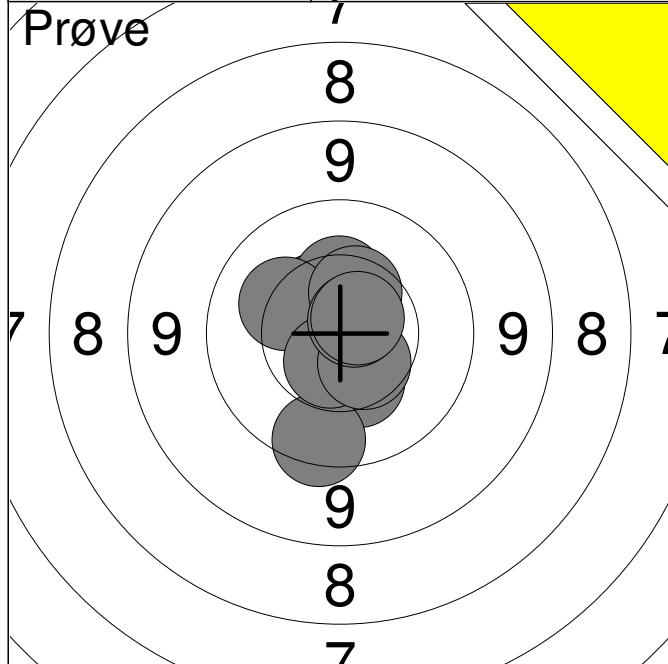

1:	10.4	↓
2:	9.7	↓
3:	10.5	↗
4:	10.4	↑
5:	10.2	↖
6:	10.6x	↓
7:	10.4	↑
8:	10.5	↓
9:	10.7x	↗
10:	10.7x	↗
<b>Serie</b>		<b>99.0</b>
<b>Total</b>		<b>0.0</b>

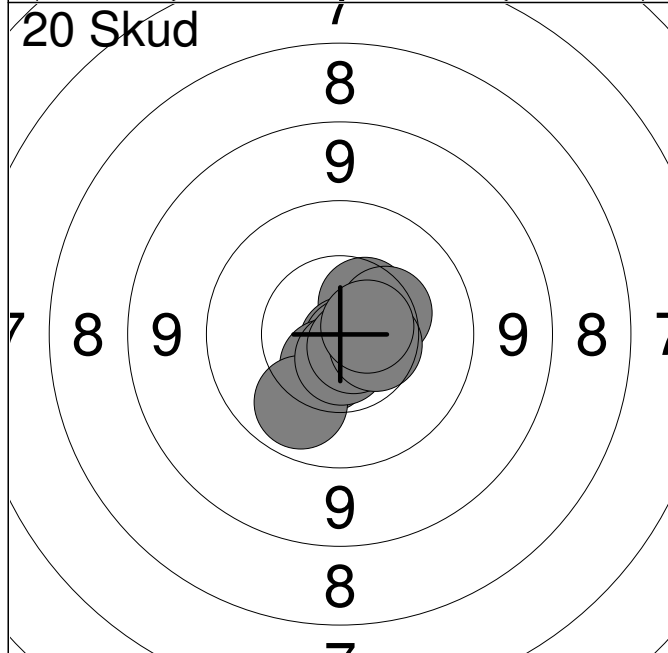

1:	10.5	↗
2:	10.8x	↓
3:	10.8x	↓
4:	10.6	↓
5:	10.0	↓
6:	10.7x	↓
7:	10.7x	↓
8:	10.4	→
9:	10.5	→
10:	10.6x	→
<b>Serie</b>		<b>100.0</b>
<b>Total</b>		<b>100.0</b>

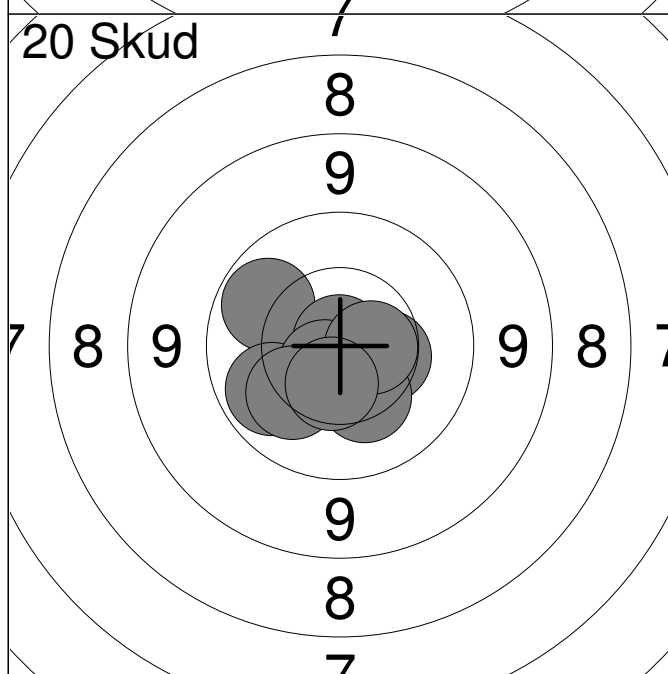

11:	10.8x	←
12:	10.4	→
13:	10.3	↓
14:	10.0	↗
15:	10.0	↖
16:	10.9x	↑
17:	10.7x	↓
18:	10.6x	→
19:	10.2	↖
20:	10.5	↓
<b>Serie</b>		<b>100.0</b>
<b>Total</b>		<b>200.0</b>

Hold	Skive	Nicoline V. Knapp	
19	1	Mou & Omegns Skf.	MB2
15m		Jyllandsstævne 2015	Aalborg Skyttekreds
11.02.2015			
Prøve		1:	10.6x ↗
		2:	9.7 ↗
		3:	10.3 ↑
		4:	10.3 →
		5:	9.9 →
		6:	10.0 ↑
		7:	9.9 ←
		8:	10.5x ←
		9:	9.7 ←
		10:	10.0 ↓
		Serie	
Total		0.0	
20 Skud		1:	9.7 ←
		2:	10.1 ↗
		3:	10.4 ↑
		4:	10.1 ←
		5:	10.3 ↗
		6:	10.5 ↓
		7:	9.9 ↓
		8:	9.8 ←
		9:	10.4 ↙
		10:	10.2 ↑
		Serie	
Total		97.0	
20 Skud		11:	9.8 ↙
		12:	9.9 ←
		13:	10.2 ↓
		14:	10.7x →
		15:	10.7x ↙
		16:	10.7x ←
		17:	9.1 ↗
		18:	10.7x ↓
		19:	10.3 ←
		20:	10.6x ←
		Serie	
Total		194.0	

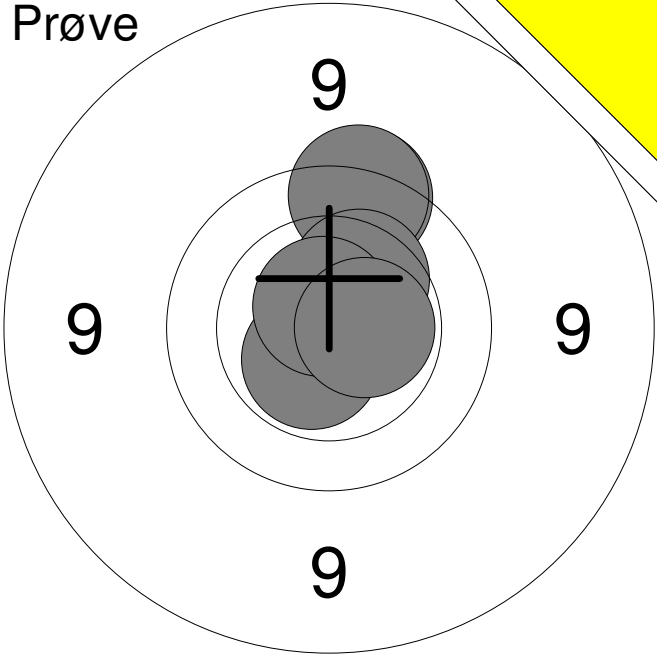
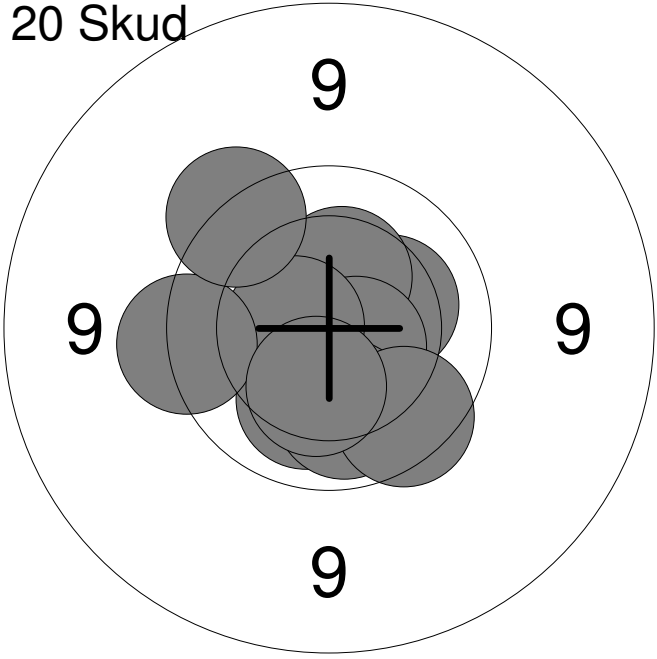
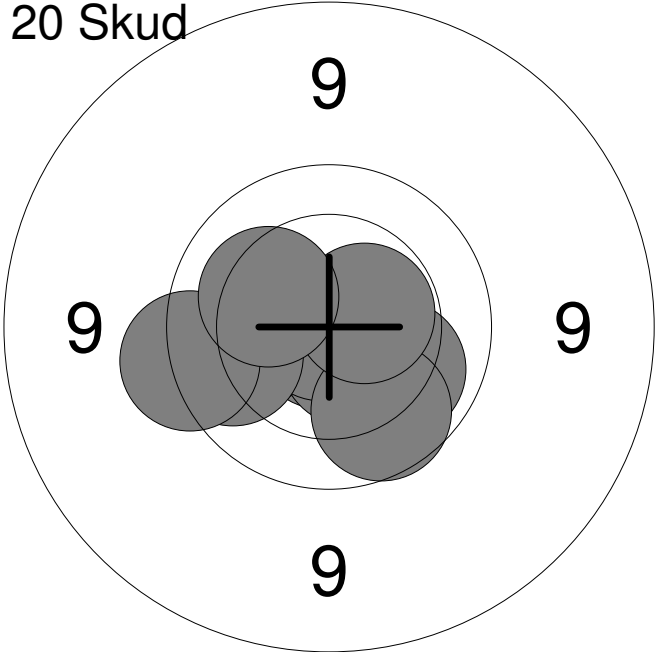
Hold	Skive	Nina Guldbæk Larsen	
19	2	Mou & Omegns Skf.	MB2
15m			
11.02.2015	Jyllandsstævne 2015	Aalborg Skyttekreds	
Prøve		1: 9.7	↑
		2: 9.7	↑
		3: 10.6x	↙
		4: 10.3	↗
		5: 10.7x	↑
		6: 10.6x	→
		<b>Serie</b>	<b>58.0</b>
		<b>Total</b>	<b>0.0</b>
20 Skud		1: 10.3	→
		2: 10.4	↑
		3: 10.6x	↘
		4: 10.1	↙
		5: 10.6x	←
		6: 10.1	↙
		7: 9.6	←
		8: 9.6	↗
		9: 9.8	↘
		10: 10.3	↘
		<b>Serie</b>	<b>97.0</b>
		<b>Total</b>	<b>97.0</b>
20 Skud		11: 10.8x	↙
		12: 10.1	←
		13: 10.6x	↘
		14: 10.9x	←
		15: 9.9	←
		16: 10.1	↘
		17: 9.9	↘
		18: 10.5x	→
		19: 9.6	←
		20: 10.2	↖
		<b>Serie</b>	<b>97.0</b>
		<b>Total</b>	<b>194.0</b>

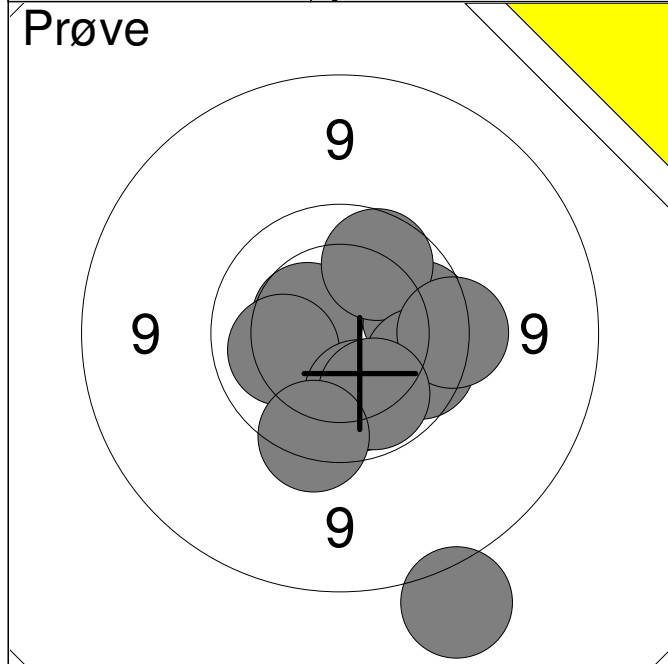

1:	8.5	↓
2:	9.9	→
3:	10.5	↗
4:	9.9	↗
5:	10.1	←
6:	9.9	↓
7:	10.1	↓
8:	9.6	→
9:	10.0	↓
10:	9.7	↓
<b>Serie</b>		<b>93.0</b>
<b>Total</b>		<b>0.0</b>

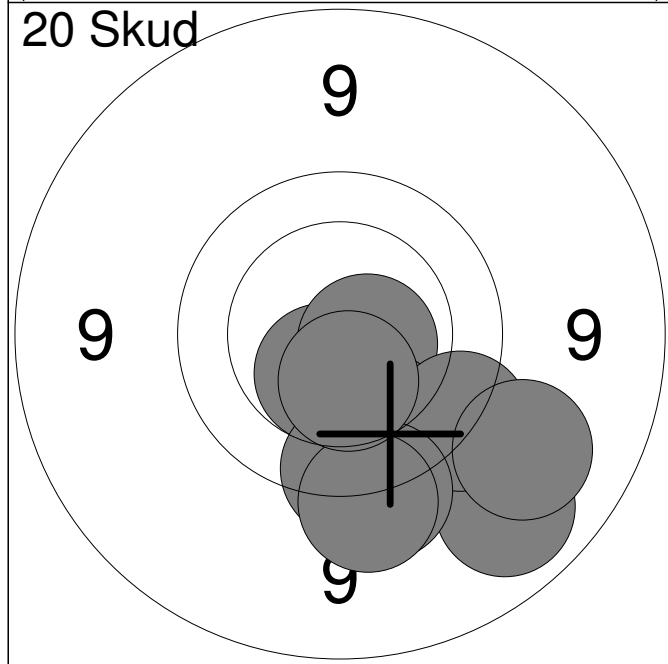

1:	10.5x	↓
2:	10.6x	→
3:	9.9	↓
4:	9.1	↓
5:	9.7	↓
6:	9.6	↓
7:	9.5	↓
8:	9.5	↓
9:	10.4	↓
10:	9.2	↓
<b>Serie</b>		<b>93.0</b>
<b>Total</b>		<b>93.0</b>

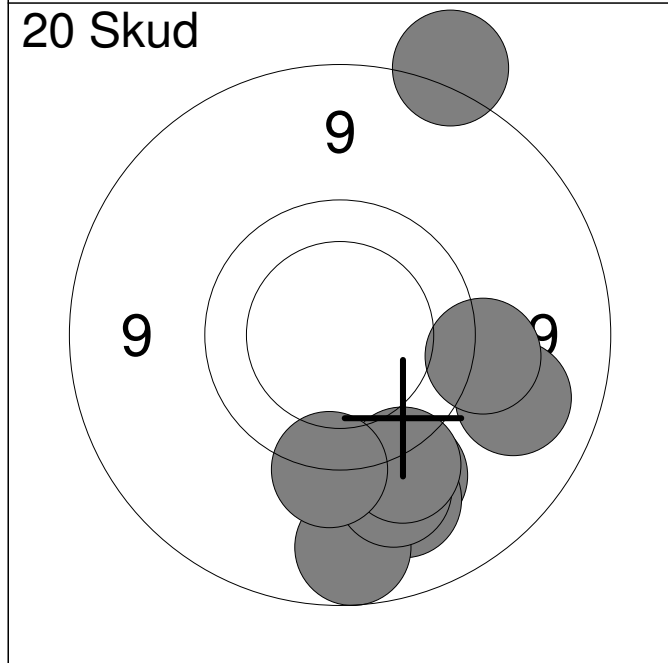

11:	9.3	↓
12:	9.2	→
13:	9.4	↓
14:	9.2	↓
15:	8.9	↓
16:	9.3	↓
17:	9.5	↓
18:	9.5	→
19:	8.6	↗
20:	9.5	↓
<b>Serie</b>		<b>88.0</b>
<b>Total</b>		<b>181.0</b>

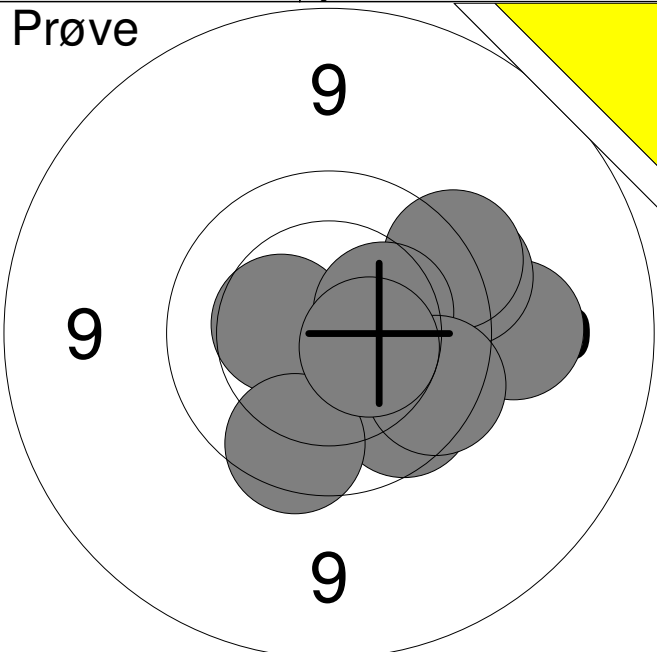
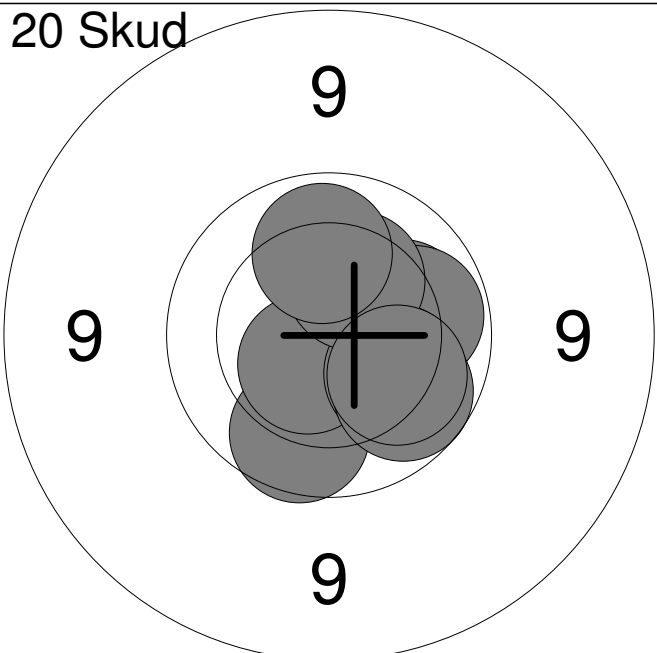
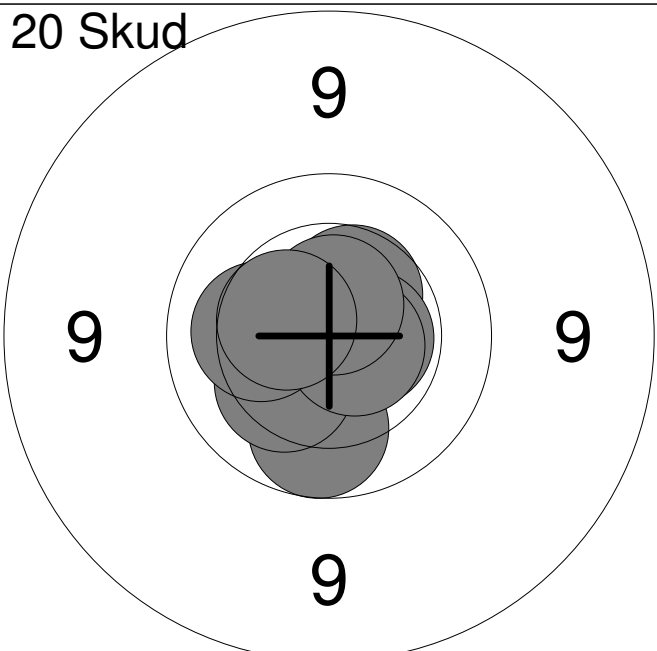

Hold	Skive	Jens Niss	
19	4	Mou & Omegns Skf.	MÅ2
15m			
11.02.2015	Jyllandsstævne 2015	Aalborg Skyttekreds	
Prøve		1: 10.8x ↘ 2: 10.4 ← 3: 9.4 → 4: 9.9 ↘ 5: 9.6 → 6: 9.6 ↗ 7: 10.3 → 8: 9.8 ↘ 9: 9.8 ↘ 10: 10.5x →	
		<b>Serie</b>	<b>94.0</b>
		<b>Total</b>	<b>0.0</b>
20 Skud		1: 10.5x → 2: 10.1 → 3: 10.0 → 4: 9.9 ↘ 5: 10.6x ↘ 6: 10.1 ↘ 7: 10.3 ↗ 8: 10.1 ↑ 9: 10.0 ↘ 10: 10.1 ↘	
		<b>Serie</b>	<b>99.0</b>
		<b>Total</b>	<b>99.0</b>
20 Skud		11: 10.4 ↗ 12: 10.8x ↗ 13: 9.9 ↘ 14: 10.6x ← 15: 10.3 ↘ 16: 10.6x → 17: 10.7x → 18: 10.6x ↑ 19: 10.2 ← 20: 10.5 ←	
		<b>Serie</b>	<b>99.0</b>
		<b>Total</b>	<b>198.0</b>

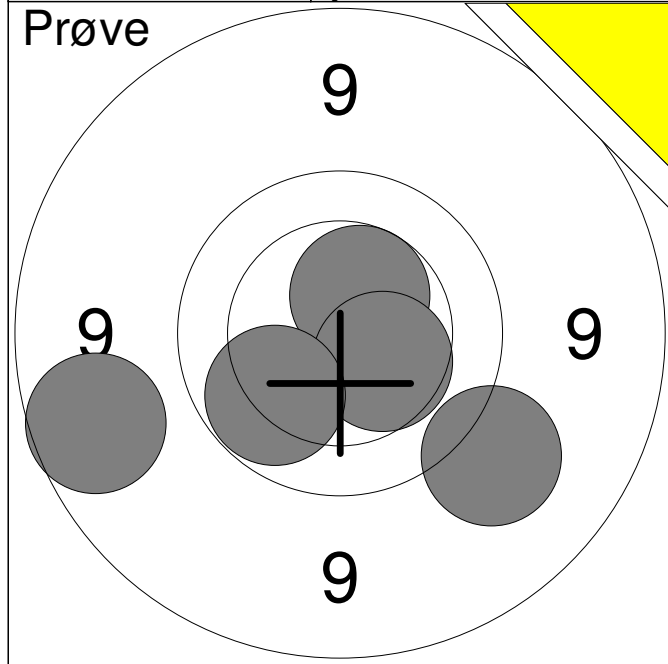

1:	10.5	↗
2:	9.3	↘
3:	10.4	↘
4:	8.9	↖
5:	10.0	↙
<b>Serie</b>		<b>47.0</b>
<b>Total</b>		<b>0.0</b>

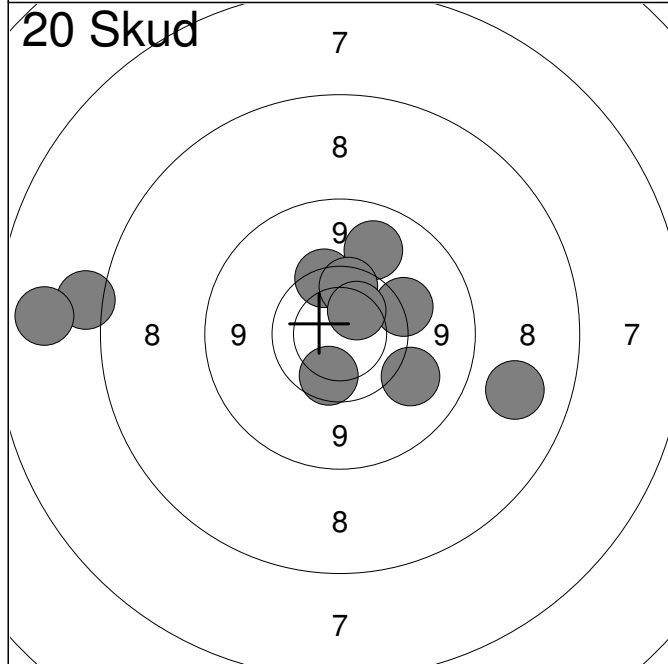

1:	9.9	↘
2:	9.5	→
3:	9.3	↘
4:	7.5	←
5:	9.2	↗
6:	9.7	↗
7:	9.8	↗
8:	7.1	←
9:	10.2	↗
10:	8.2	→
<b>Serie</b>		<b>86.0</b>
<b>Total</b>		<b>86.0</b>

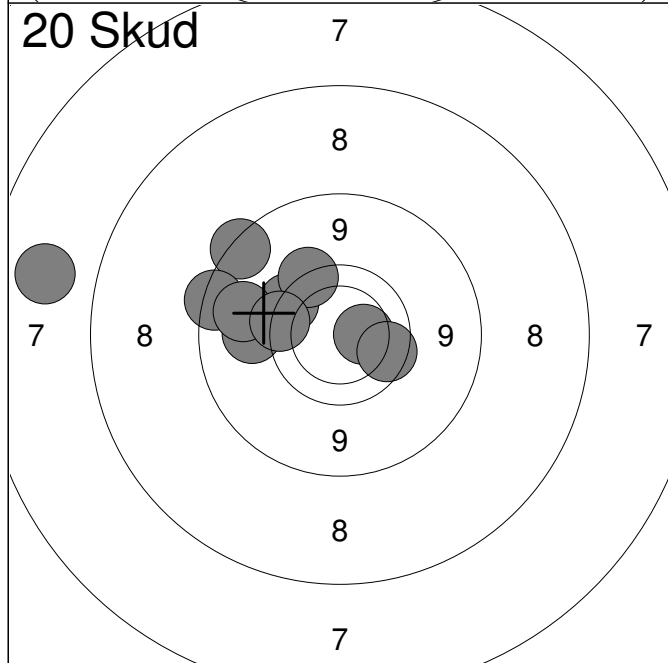

11:	9.3	←
12:	8.8	↗
13:	10.4	→
14:	9.7	↗
15:	7.2	←
16:	8.8	↗
17:	9.6	↗
18:	9.1	↗
19:	9.8	↘
20:	9.6	←
<b>Serie</b>		<b>87.0</b>
<b>Total</b>		<b>173.0</b>

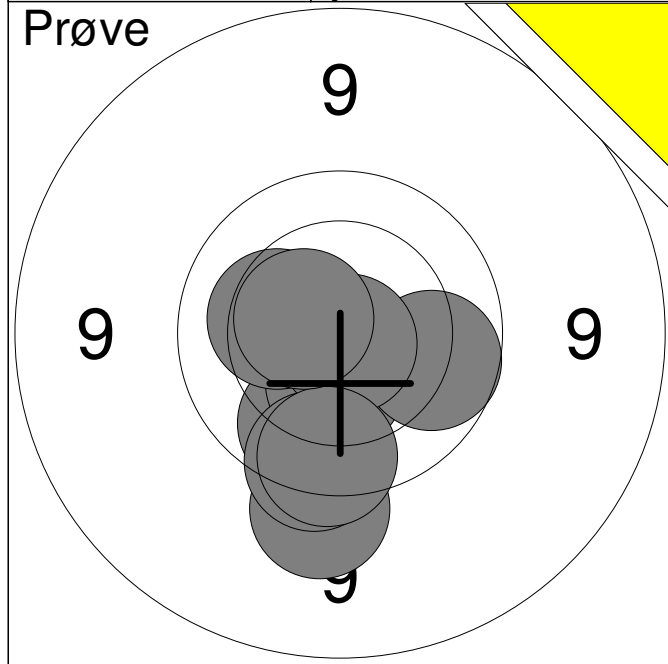

1:	9.4	↓
2:	9.9	↓
3:	10.4	↓
4:	9.9	→
5:	10.3	←
6:	9.7	↓
7:	10.8x	↓
8:	9.8	↓
9:	10.5x	↗
<b>Serie</b>		<b>85.0</b>
<b>Total</b>		<b>0.0</b>

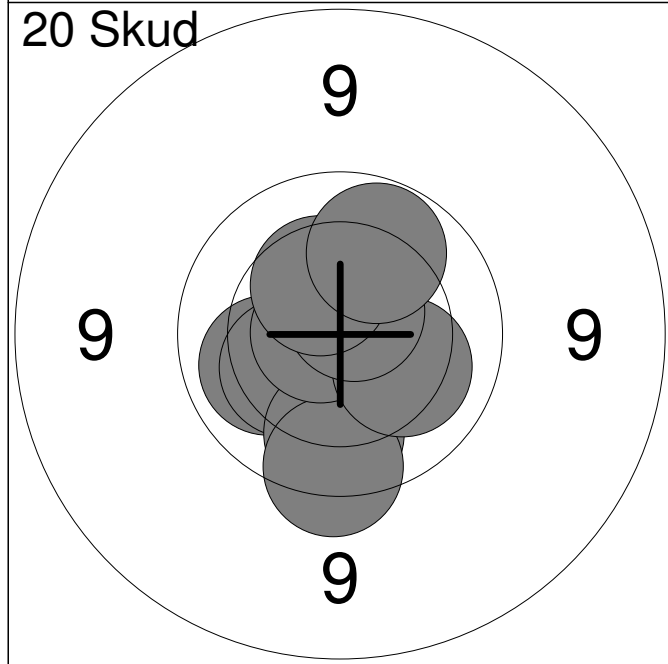

1:	10.1	←
2:	10.3	←
3:	9.9	↓
4:	9.7	↓
5:	10.8x	↗
6:	10.7x	←
7:	10.2	→
8:	10.7x	↗
9:	10.4	↗
10:	10.0	↗
<b>Serie</b>		<b>98.0</b>
<b>Total</b>		<b>98.0</b>

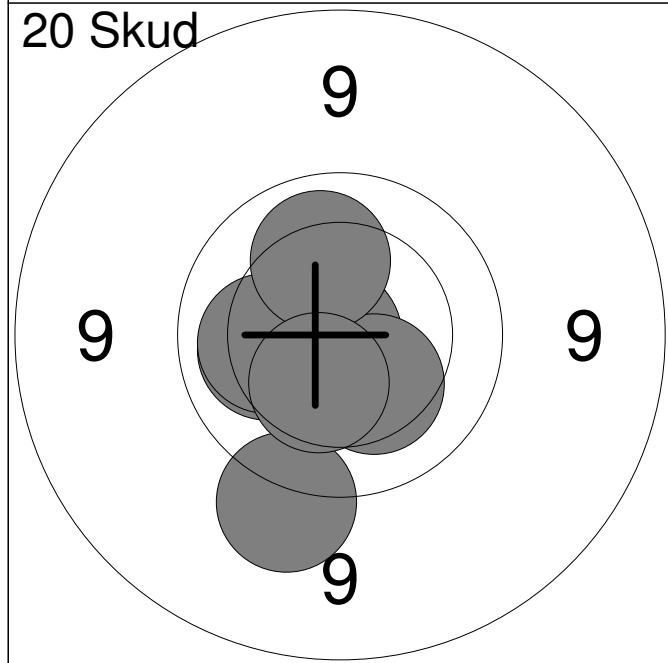

11:	10.1	←
12:	10.5	←
13:	10.7x	↓
14:	10.8x	↗
15:	10.9x	←
16:	9.4	↓
17:	10.2	←
18:	10.3	↓
19:	10.1	↗
20:	10.4	↓
<b>Serie</b>		<b>99.0</b>
<b>Total</b>		<b>197.0</b>

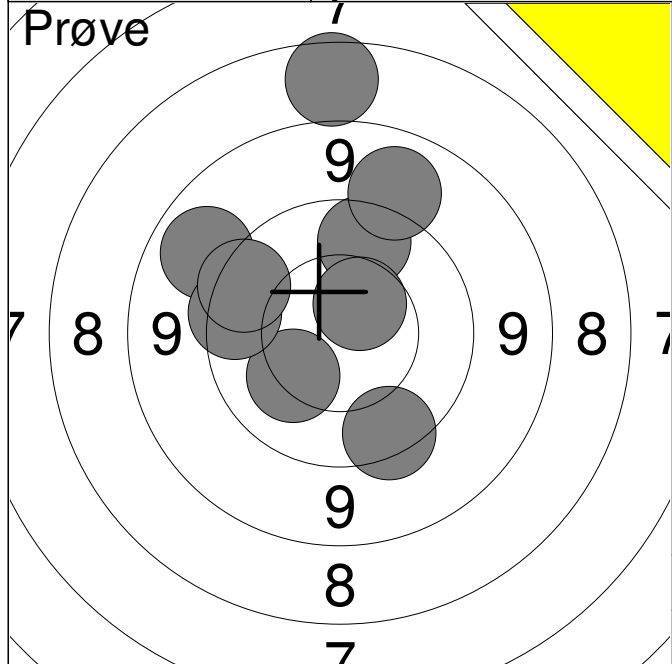

1:	7.8	↑
2:	9.1	↖
3:	10.2	↙
4:	9.8	↑
5:	10.5	↗
6:	9.7	←
7:	9.1	↑
8:	9.7	↗
9:	9.6	↓
<b>Serie</b>		<b>81.0</b>
<b>Total</b>		<b>0.0</b>

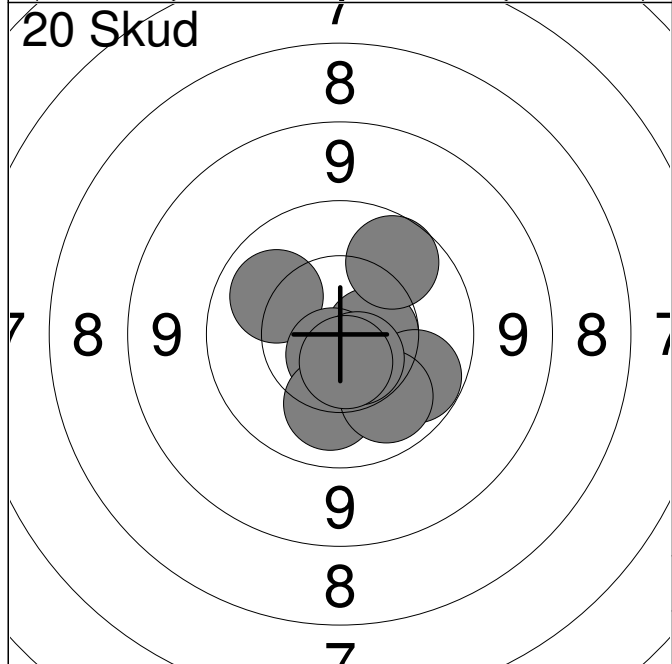

1:	10.1	↗
2:	10.1	↓
3:	10.6	→
4:	10.7x	↓
5:	9.9	↗
6:	10.0	↓
7:	10.1	↓
8:	10.1	↓
9:	10.6x	↓
10:	10.6x	↓
<b>Serie</b>		<b>99.0</b>
<b>Total</b>		<b>99.0</b>

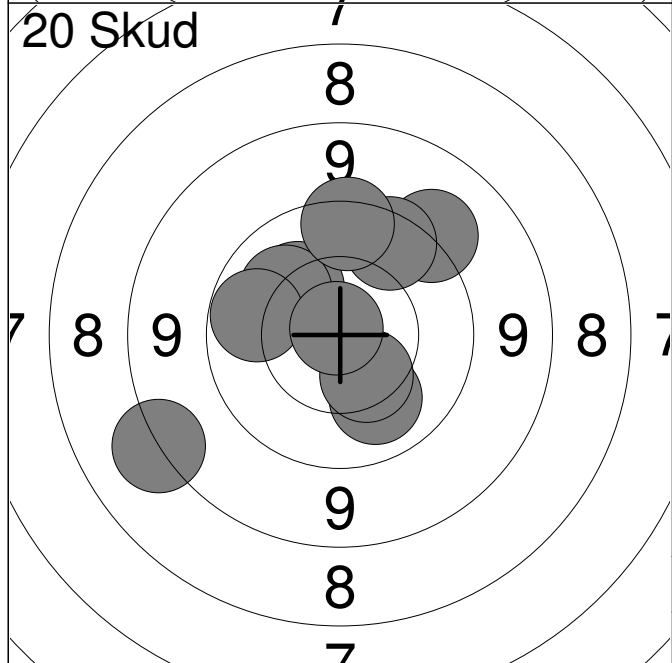

11:	9.3	↗
12:	8.3	↙
13:	10.2	↗
14:	10.1	↓
15:	10.1	↗
16:	10.0	←
17:	9.7	↗
18:	9.6	↑
19:	10.4	↓
20:	10.9x	↗
<b>Serie</b>		<b>95.0</b>
<b>Total</b>		<b>194.0</b>

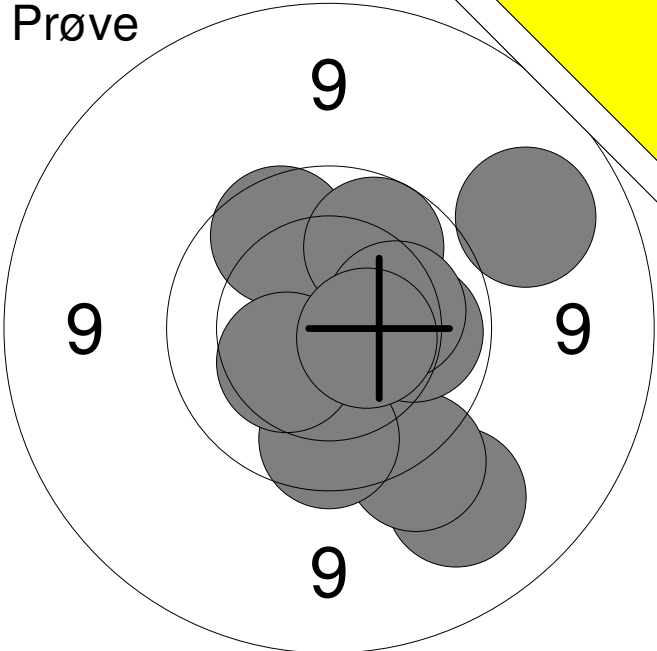
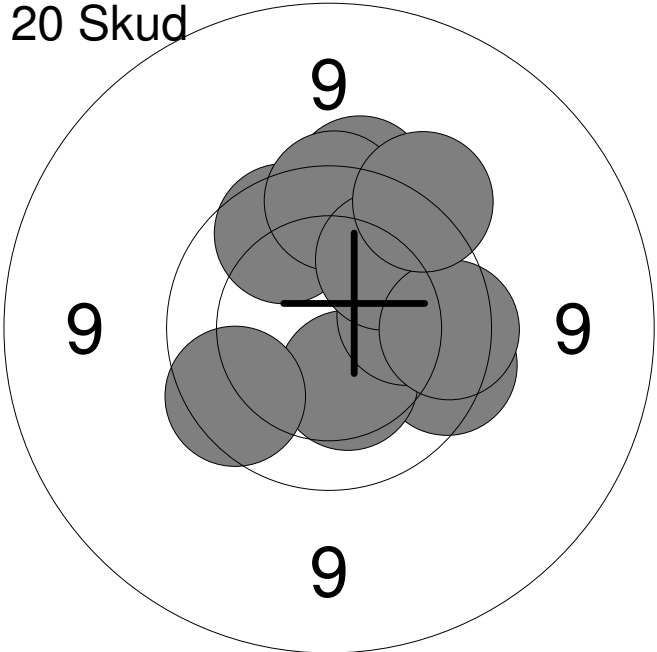
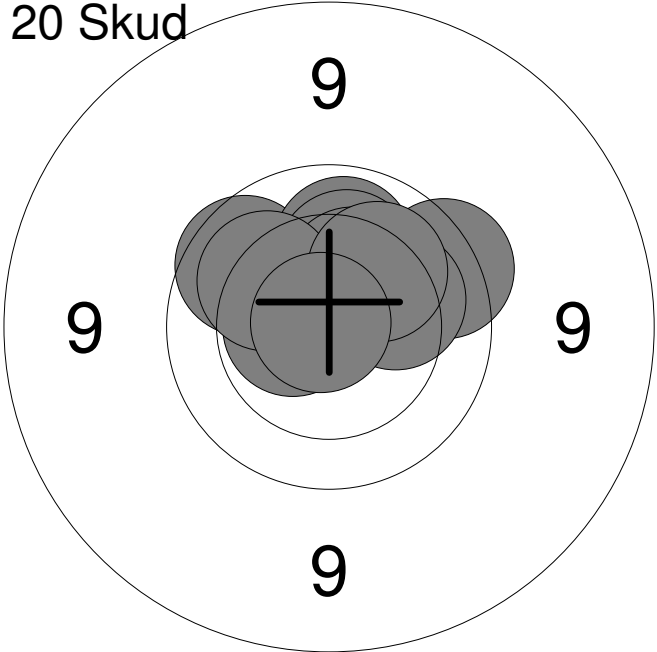
Hold	Skive	Michael Guldbæk Larsen	
19	8	Mou & Omegns Skf.	MÅ3
15m			
11.02.2015	Jyllandsstævne 2015	Aalborg Skyttekreds	
<b>Prøve</b> 	1:	9.2	↘
	2:	9.5	↘
	3:	9.8	↘
	4:	9.9	↗
	5:	10.4	↙
	6:	9.9	↗
	7:	10.0	→
	8:	9.1	↗
	9:	10.2	→
	10:	10.5x	→
	<b>Serie</b>		<b>94.0</b>
<b>Total</b>		<b>0.0</b>	
<b>20 Skud</b> 	1:	9.8	→
	2:	10.4	↘
	3:	9.8	↙
	4:	9.9	↗
	5:	9.6	↗
	6:	10.1	→
	7:	9.7	↗
	8:	10.0	↗
	9:	9.8	→
	10:	9.6	↗
<b>Serie</b>		<b>93.0</b>	
<b>Total</b>		<b>93.0</b>	
<b>20 Skud</b> 	11:	10.6x	←
	12:	9.9	↖
	13:	9.7	↗
	14:	10.1	↗
	15:	10.2	↗
	16:	10.2	→
	17:	10.4	↗
	18:	10.1	↖
	19:	10.2	↗
	20:	10.8x	↖
<b>Serie</b>		<b>98.0</b>	
<b>Total</b>		<b>191.0</b>	

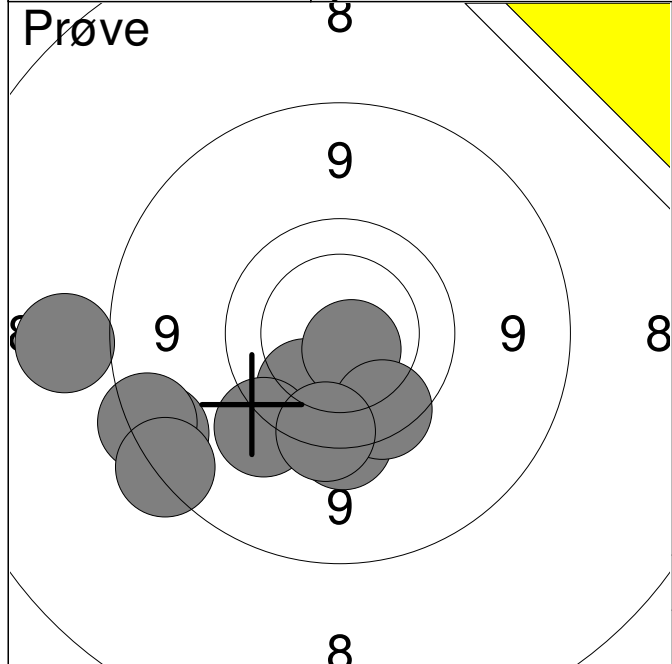

1:	10.0	↙
2:	8.8	↙
3:	10.7x	↘
4:	9.5	↙
5:	8.8	↙
6:	9.6	↘
7:	9.8	↘
8:	9.7	↘
9:	8.4	↙
10:	8.7	↙

<b>Serie</b>	<b>88.0</b>
--------------	-------------

<b>Total</b>	<b>0.0</b>
--------------	------------

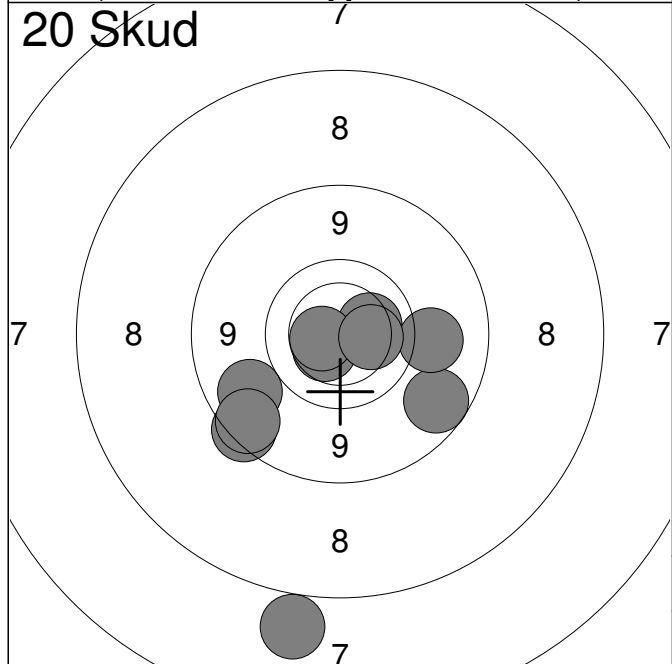

1:	9.1	↙
2:	10.5	↙
3:	9.0	↘
4:	10.2	→
5:	7.4	↘
6:	9.3	→
7:	10.5x	↙
8:	8.8	↙
9:	8.9	↙
10:	10.2	→

<b>Serie</b>	<b>90.0</b>
--------------	-------------

<b>Total</b>	<b>90.0</b>
--------------	-------------

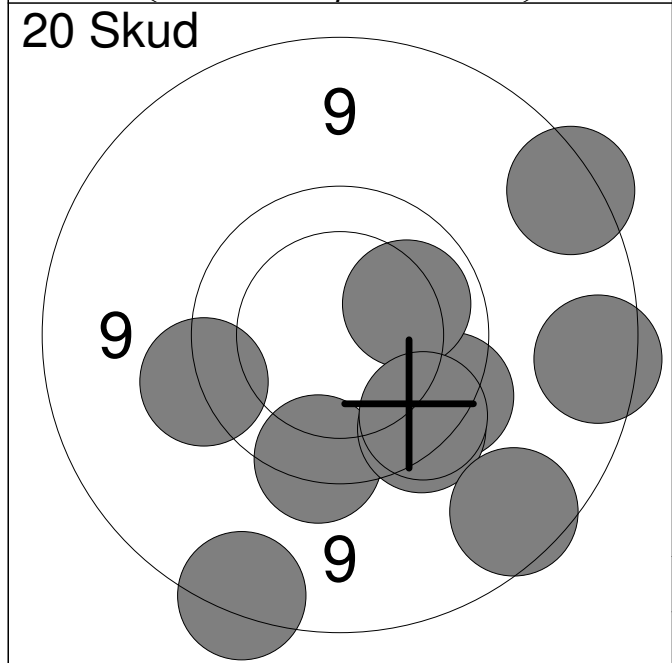

11:	9.7	↘
12:	9.7	↘
13:	9.7	↘
14:	8.8	→
15:	10.1	→
16:	9.6	↙
17:	9.7	↘
18:	8.8	→
19:	8.9	↘
20:	8.8	↘

<b>Serie</b>	<b>87.0</b>
--------------	-------------

<b>Total</b>	<b>177.0</b>
--------------	--------------

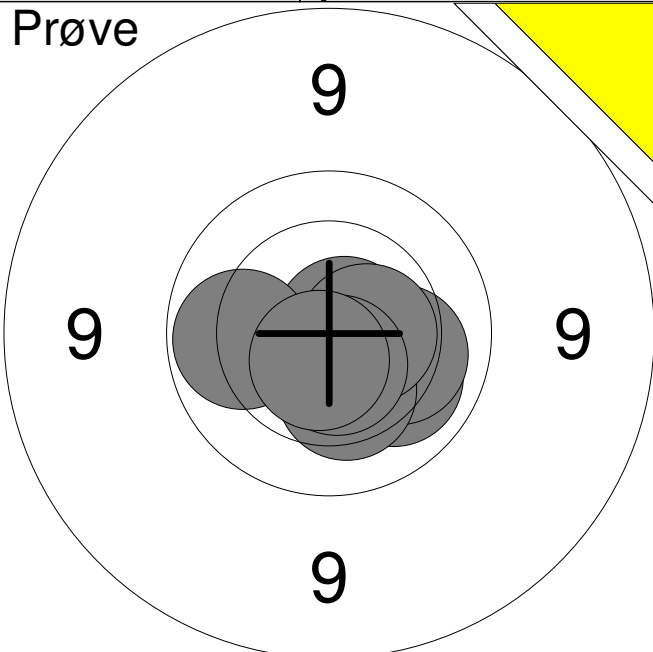
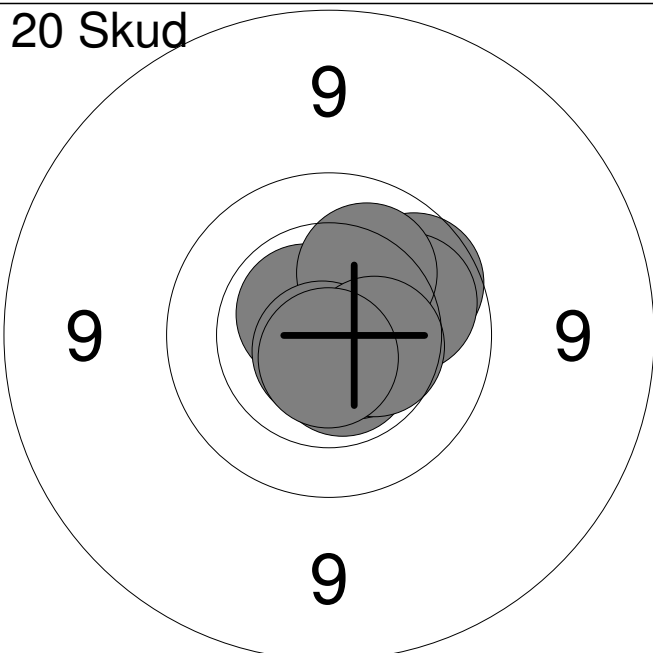
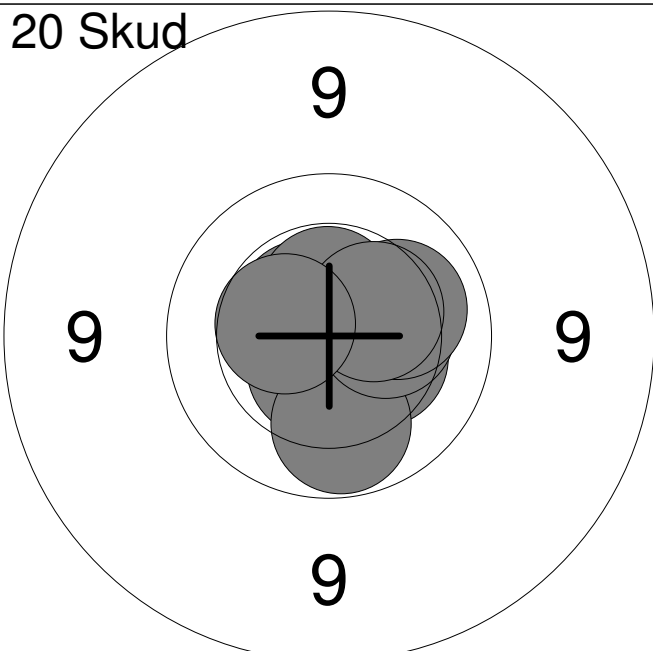
Hold	Skive	Emil L. Nielsen	
19	10	15m	Vester Hassing Skf. J1
11.02.2015	Jyllandsstævne 2015	Aalborg Skyttekreds	
Prøve		1: 10.1 ↘	
		2: 10.2 ↘	
		3: 10.3 ↘	
		4: 10.8x →	
		5: 10.5x →	
		6: 10.0 ←	
		7: 10.6x ↘	
		8: 10.6x ↘	
		<b>Serie</b>	<b>80.0</b>
		<b>Total</b>	<b>0.0</b>
20 Skud		1: 9.9 ↗	
		2: 10.0 →	
		3: 10.6x ↘	
		4: 10.6x ↘	
		5: 10.7x ↘	
		6: 10.6x ↗	
		7: 10.2 ↗	
		8: 10.8x ↘	
		9: 10.4 →	
		10: 10.7x ↘	
		<b>Serie</b>	<b>99.0</b>
		<b>Total</b>	<b>99.0</b>
20 Skud		11: 10.4 ↘	
		12: 10.6x ↗	
		13: 10.7x ←	
		14: 10.6x ↘	
		15: 10.0 ↘	
		16: 10.3 →	
		17: 10.2 →	
		18: 10.5x ↑	
		19: 10.4 ↗	
		20: 10.5 ←	
		<b>Serie</b>	<b>100.0</b>
		<b>Total</b>	<b>199.0</b>

Hold <b>19</b>	Skive <b>11</b>	<b>Louise Krogsgaard</b>	
-------------------	--------------------	--------------------------	--

15m	Vodskov Skytteforening	MB2	
-----	------------------------	-----	--

11.02.2015	Jyllandsstævne 2015	Aalborg Skyttekreds
------------	---------------------	---------------------

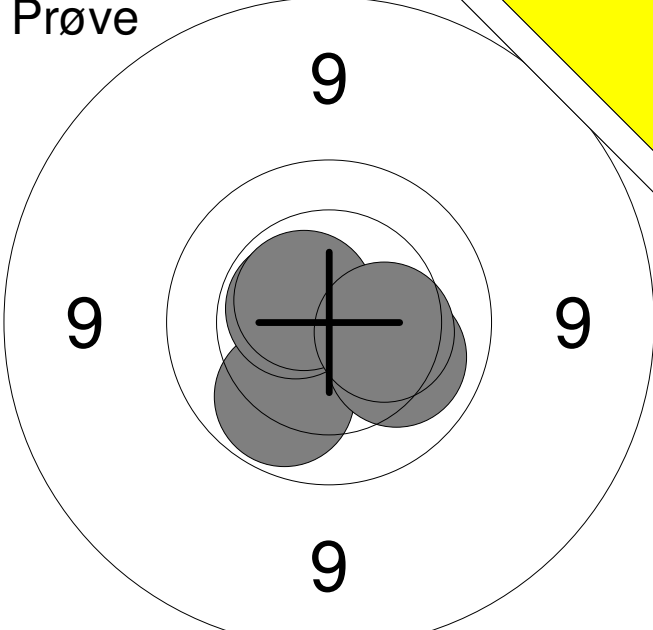
<b>Prøve</b> 	1: 10.7x	↘
	2: 10.0	↘
	3: 10.6x	↗
	4: 10.6x	↗
	5: 10.1	↘
	6: 10.3	→
	<b>Serie</b>	<b>60.0</b>
<b>Total</b>	<b>0.0</b>	

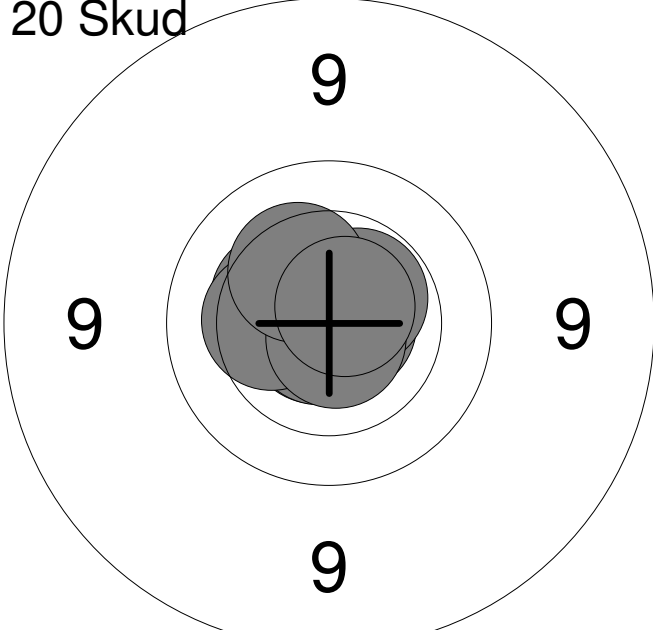
<b>20 Skud</b> 	1: 10.4	↗
	2: 10.8x	→
	3: 10.8x	↘
	4: 10.5x	↗
	5: 10.8x	↗
	6: 10.8x	↘
	7: 10.3	←
	8: 10.8x	↘
	9: 10.3	↗
	10: 10.7x	↗
	<b>Serie</b>	<b>100.0</b>
<b>Total</b>	<b>100.0</b>	

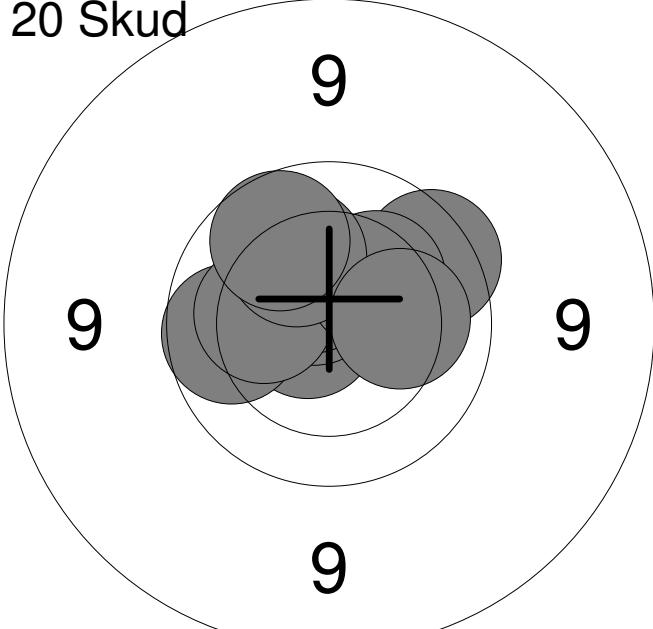
<b>20 Skud</b> 	11: 10.7x	←
	12: 9.8	↗
	13: 10.6x	↗
	14: 10.5	↗
	15: 9.9	←
	16: 10.2	←
	17: 10.3	↗
	18: 10.1	↗
	19: 10.2	→
	20: 9.9	↗
	<b>Serie</b>	<b>97.0</b>
<b>Total</b>	<b>197.0</b>	



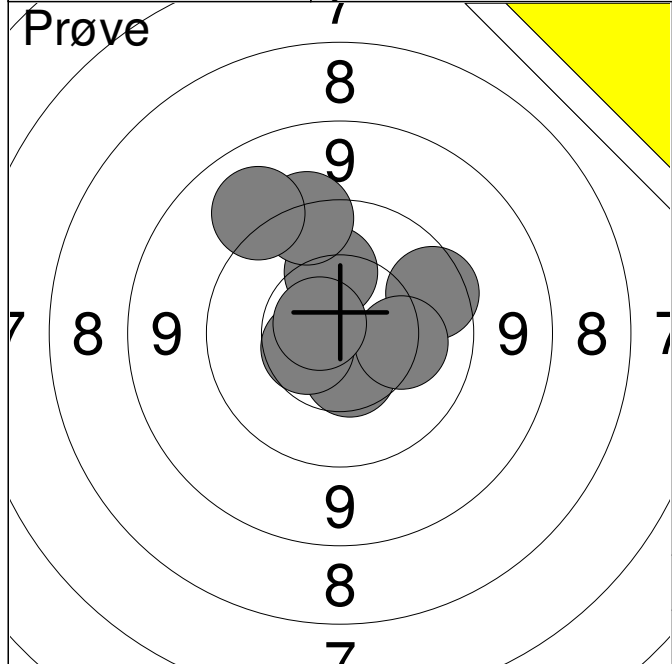

1:	10.2	↑
2:	9.5	↑
3:	9.2	↑
4:	10.5	↓
5:	9.8	→
6:	10.5	←
7:	10.2	→
8:	10.7x	↑
<b>Serie</b>		<b>77.0</b>
<b>Total</b>		<b>0.0</b>

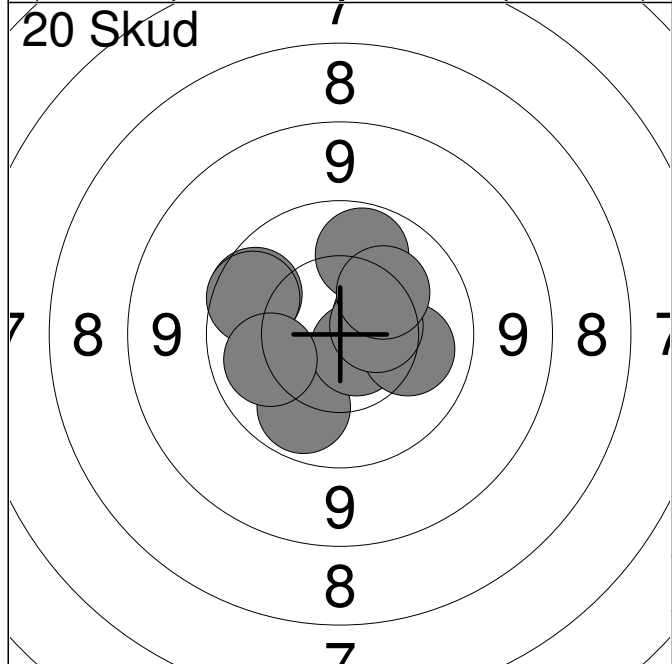

1:	9.9	←
2:	9.8	←
3:	10.5	→
4:	10.0	↓
5:	10.7x	↓
6:	10.1	→
7:	10.1	←
8:	10.0	↑
9:	10.5	→
10:	10.3	↗
<b>Serie</b>		<b>98.0</b>
<b>Total</b>		<b>98.0</b>

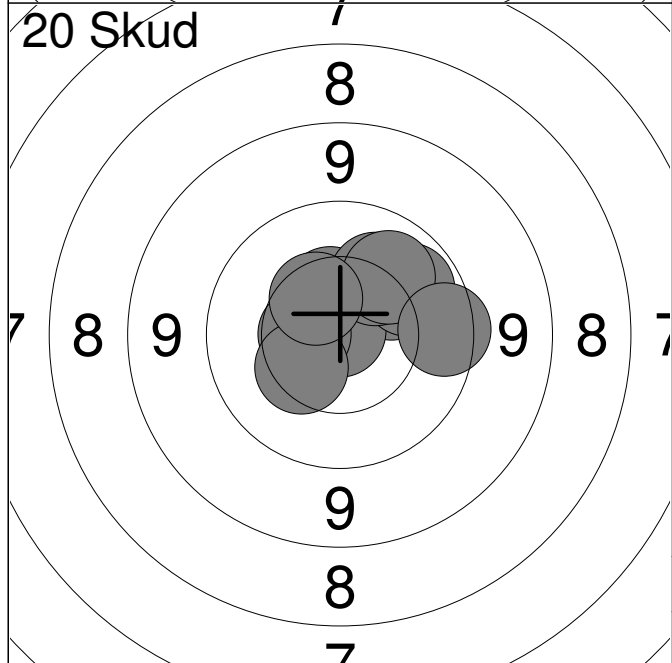

11:	10.2	↗
12:	10.5	↑
13:	10.9x	↑
14:	10.5	←
15:	10.0	↗
16:	10.2	↑
17:	10.1	↗
18:	10.4	↙
19:	9.7	→
20:	10.4	↑
<b>Serie</b>		<b>99.0</b>
<b>Total</b>		<b>197.0</b>

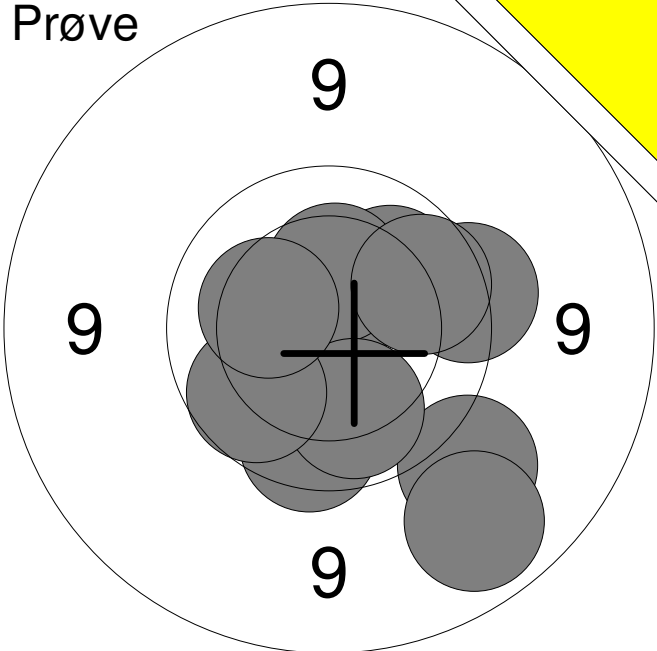
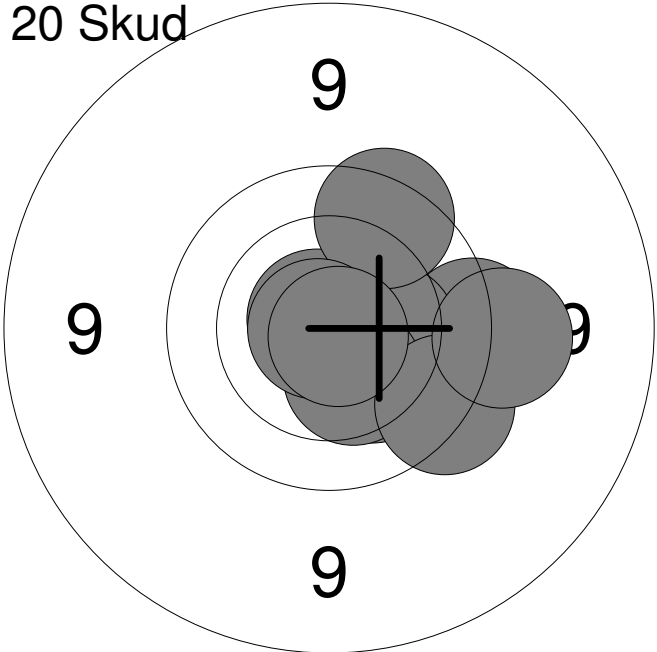
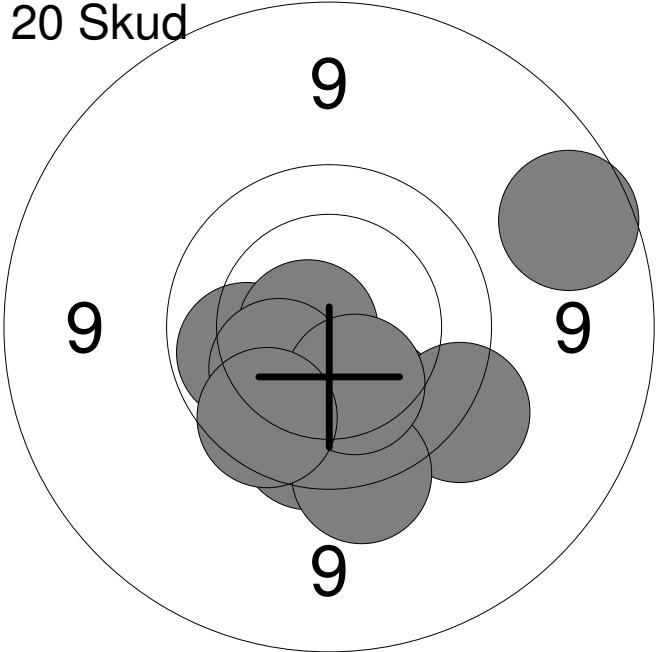
Hold	Skive	Jasmin Kristensen	
20	1	Mou & Omegns Skf.	MB2
15m		Jyllandsstævne 2015	Aalborg Skyttekreds
11.02.2015			
<b>Prøve</b> 	1:	9.3	↘
	2:	9.0	↘
	3:	10.1	↗
	4:	10.4	↑
	5:	9.8	↘
	6:	9.6	→
	7:	10.0	↘
	8:	9.9	↖
	9:	10.3	↖
	10:	9.9	→
	<b>Serie</b>		<b>94.0</b>
<b>Total</b>		<b>0.0</b>	
<b>20 Skud</b> 	1:	10.8x	↗
	2:	9.6	→
	3:	10.3	↘
	4:	10.3	→
	5:	9.8	↗
	6:	10.4	↘
	7:	10.8x	←
	8:	9.7	↘
	9:	10.8x	↘
	10:	9.5	→
<b>Serie</b>		<b>96.0</b>	
<b>Total</b>		<b>96.0</b>	
<b>20 Skud</b> 	11:	10.0	←
	12:	10.7x	←
	13:	10.2	↖
	14:	10.0	↘
	15:	9.6	↘
	16:	8.9	→
	17:	9.8	↘
	18:	9.6	↘
	19:	10.3	↘
	20:	9.8	↘
<b>Serie</b>		<b>94.0</b>	
<b>Total</b>		<b>190.0</b>	

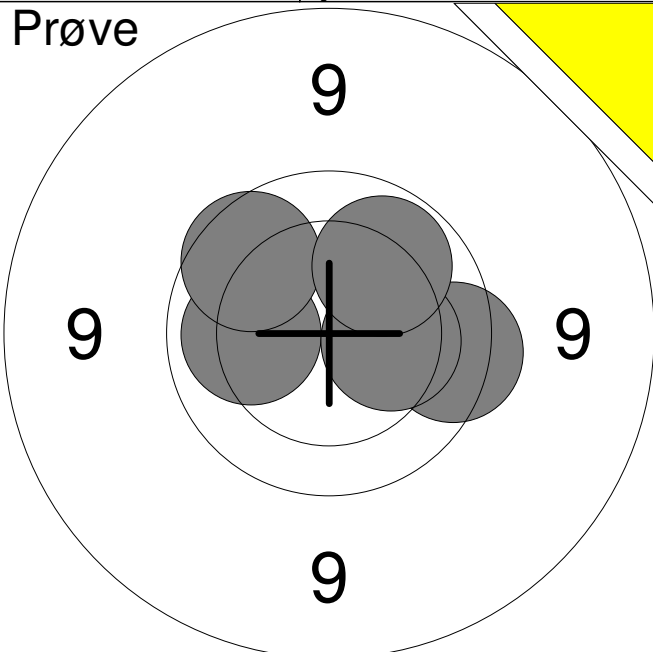
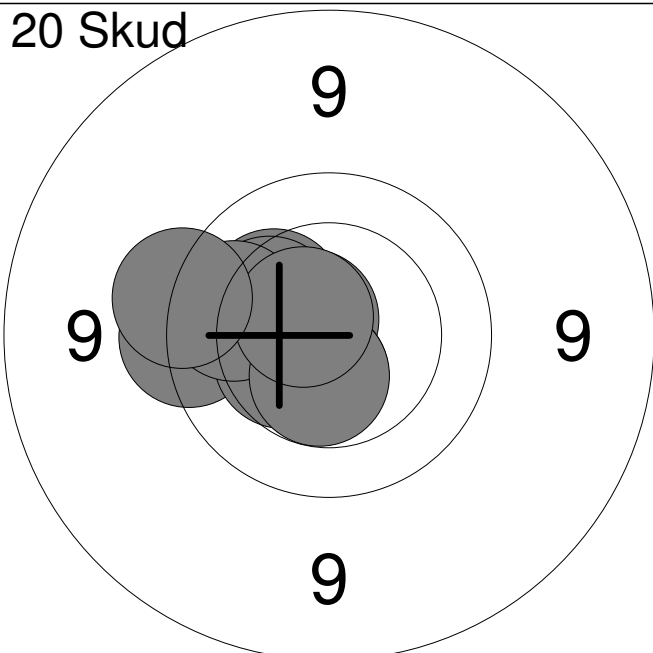
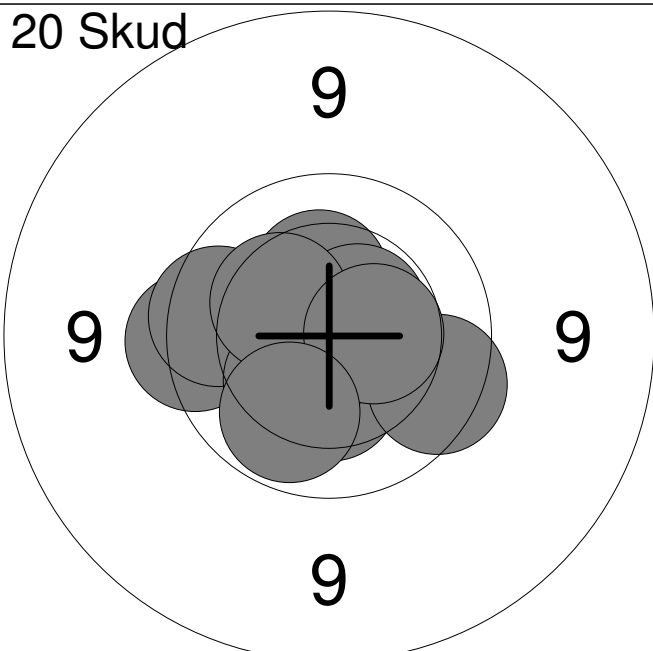
Hold	Skive	Mathias Meulengracht	
20	2	Mou & Omegns Skf.	MJ2
15m			
11.02.2015	Jyllandsstævne 2015	Aalborg Skyttekreds	
Prøve		1: 10.1 ←	
		2: 9.7 →	
		3: 9.9 ↗	
		4: 10.3 →	
		5: 10.0 ↗	
		<b>Serie</b>	<b>48.0</b>
		<b>Total</b>	<b>0.0</b>
20 Skud		1: 10.7x ↗	
		2: 10.5x ↓	
		3: 10.2 ↗	
		4: 10.2 ↗	
		5: 9.7 ←	
		6: 10.4 ←	
		7: 9.9 ←	
		8: 10.5x ↓	
		9: 10.6x ↗	
		10: 9.6 ←	
		<b>Serie</b>	<b>97.0</b>
		<b>Total</b>	<b>97.0</b>
20 Skud		11: 10.3 ↑	
		12: 10.4 ↓	
		13: 10.6x ↗	
		14: 9.7 ←	
		15: 9.8 ←	
		16: 10.3 ↙	
		17: 10.3 ↗	
		18: 9.8 →	
		19: 10.5 →	
		20: 10.0 ↓	
		<b>Serie</b>	<b>97.0</b>
		<b>Total</b>	<b>194.0</b>

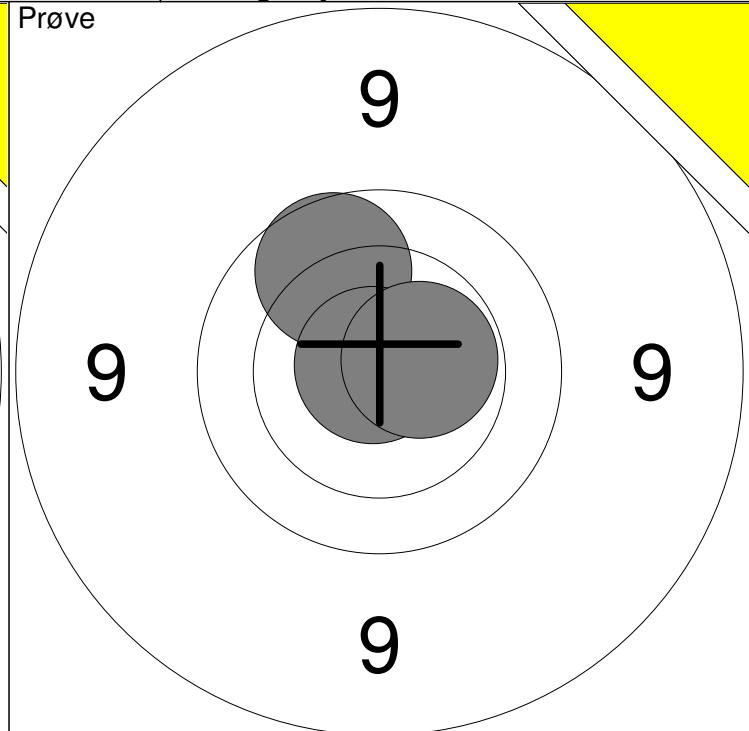
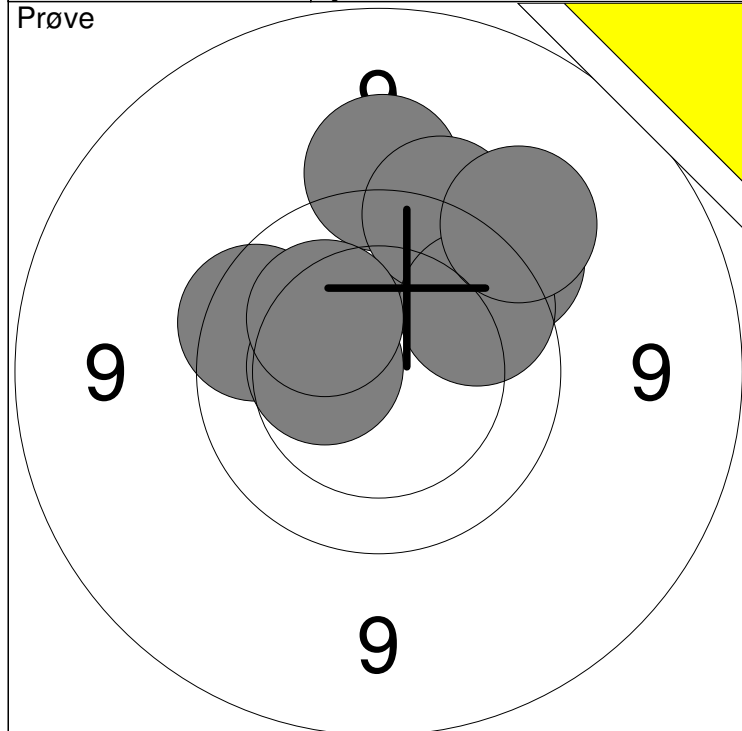

1: 9.8 ↙	6: 9.6 ↗	Serie	92
2: 9.4 ↑	7: 9.6 ↑		
3: 10.4 ←	8: 9.9 ↗	Total	0
4: 9.8 ↗	9: 9.4 ↗		
5: 9.6 ↗	10: 10.2 ↖		

11: 9.9 ↗	Serie	29
12: 10.9x ↖		
13: 10.5x →	Total	0

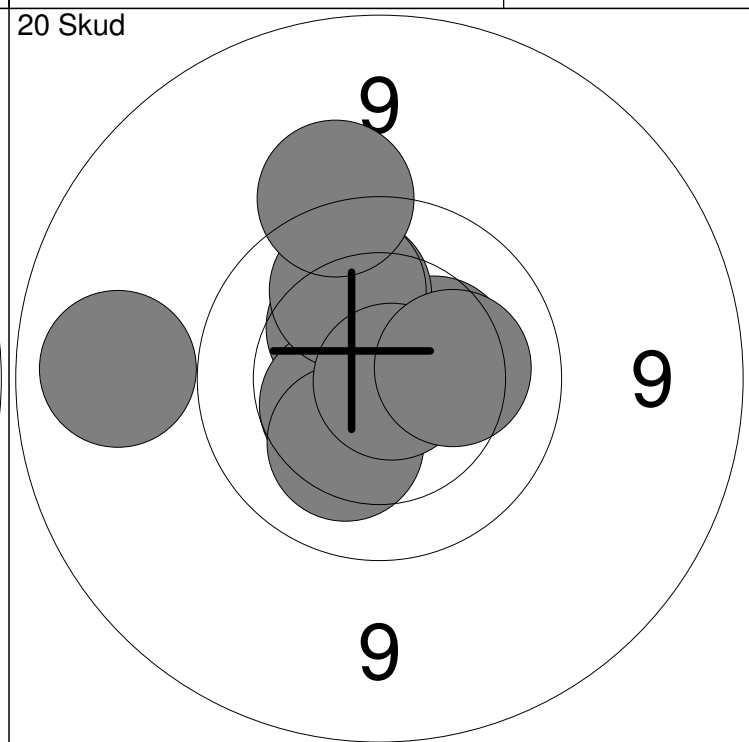
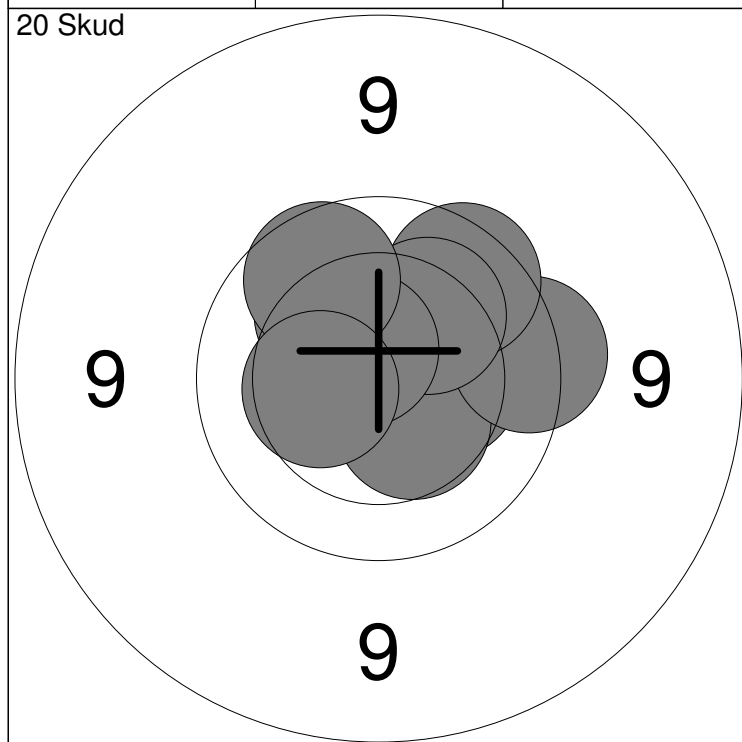

1: 10.3 ↗	6: 9.8 ↗	Serie	97
2: 10.3 →	7: 10.2 ↗		
3: 10.2 ↗	8: 10.6x ↗	Total	97
4: 10.4 ↘	9: 9.9 ↗		
5: 9.7 →	10: 10.4 ←		

11: 10.4 →	16: 10.0 ↗	Serie	98
12: 10.1 ↗	17: 9.5 ↗		
13: 10.4 ↖	18: 9.1 ←	Total	195
14: 10.5 ↖	19: 10.8x →		
15: 10.2 ↘	20: 10.2 →		

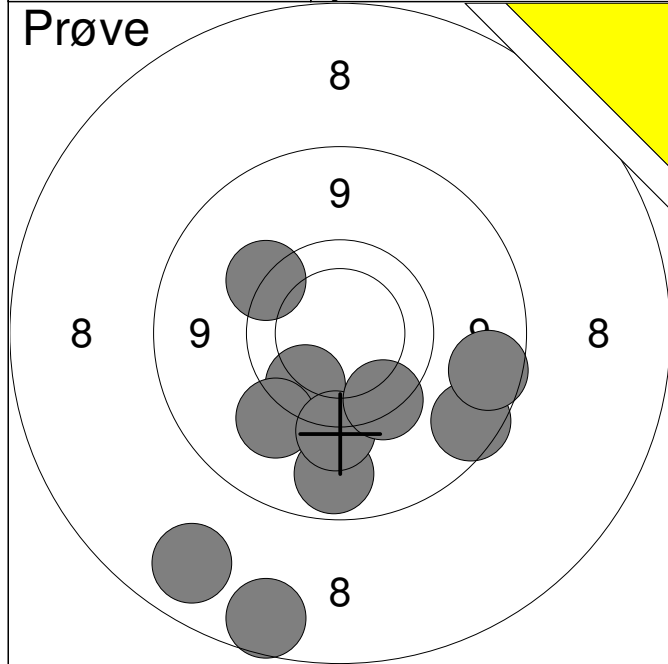

1:	9.9	↙
2:	9.4	↙
3:	9.0	↓
4:	8.9	↘
5:	7.9	↙
6:	9.5	↙
7:	9.7	↙
8:	8.9	→
9:	8.1	↙
10:	9.5	↗
<b>Serie</b>		<b>85.0</b>
<b>Total</b>		<b>0.0</b>

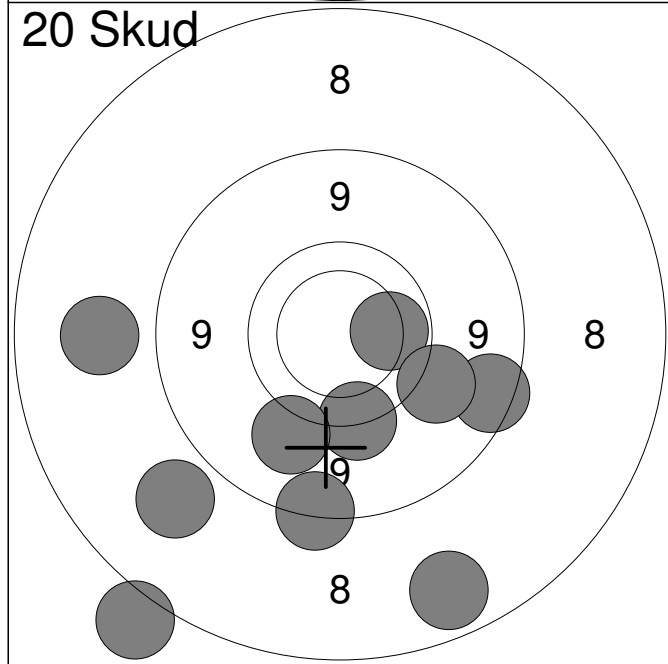

1:	8.0	↙
2:	8.3	↙
3:	8.7	↓
4:	9.6	↓
5:	8.8	→
6:	8.3	←
7:	10.0	→
8:	7.5	↙
9:	9.3	↙
10:	9.3	↘
<b>Serie</b>		<b>84.0</b>
<b>Total</b>		<b>84.0</b>

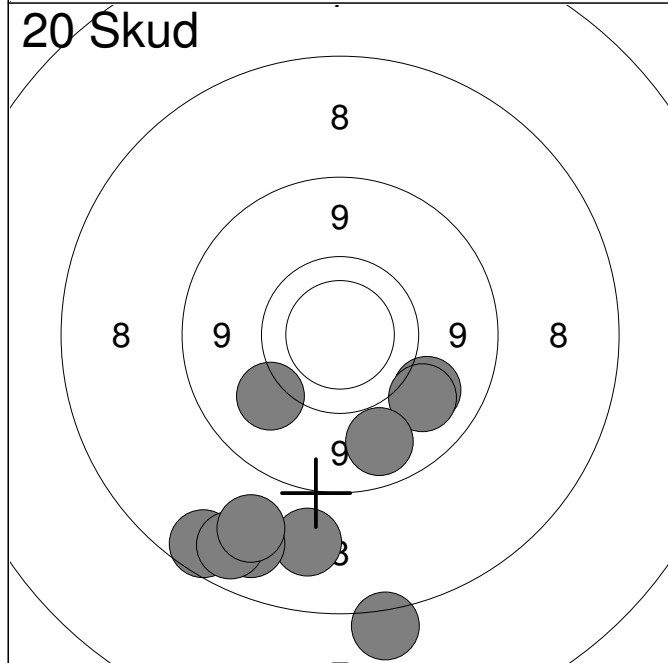

11:	7.5	↓
12:	7.9	↙
13:	8.2	↓
14:	8.1	↙
15:	9.2	↘
16:	8.0	↙
17:	9.2	↘
18:	9.1	↙
19:	9.3	↙
20:	8.2	↙
<b>Serie</b>		<b>82.0</b>
<b>Total</b>		<b>166.0</b>

Hold <b>20</b>	Skive <b>5</b>	<b>Jessie Meulengracht</b>	
-------------------	-------------------	----------------------------	--

15m	Mou & Omegns Skf.	MÅ3
-----	-------------------	-----

11.02.2015	Jyllandsstævne 2015	Aalborg Skyttekreds
------------	---------------------	---------------------

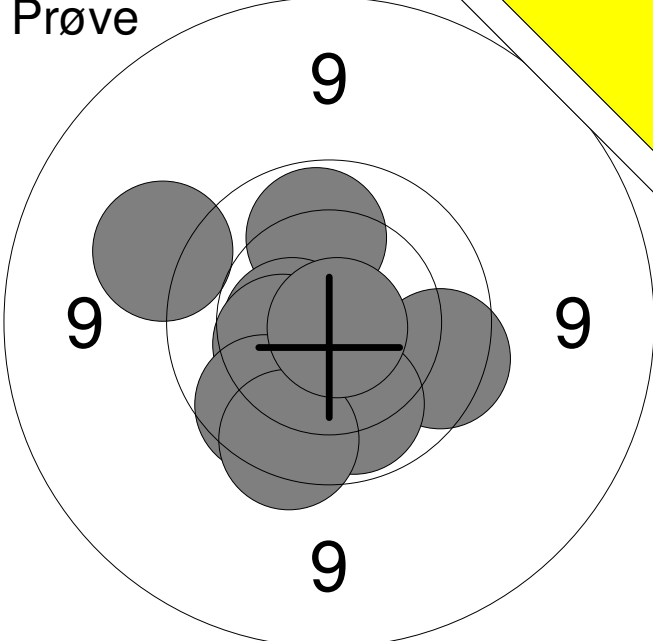
<b>Prøve</b> 	1:	10.0	↑
	2:	9.4	↖
	3:	10.5x	←
	4:	10.1	↓
	5:	9.8	→
	6:	10.0	↓
	7:	10.4	↖
	8:	9.9	↙
	9:	9.8	↓
	10:	10.8x	↘
	<b>Serie</b>		<b>96.0</b>
<b>Total</b>		<b>0.0</b>	

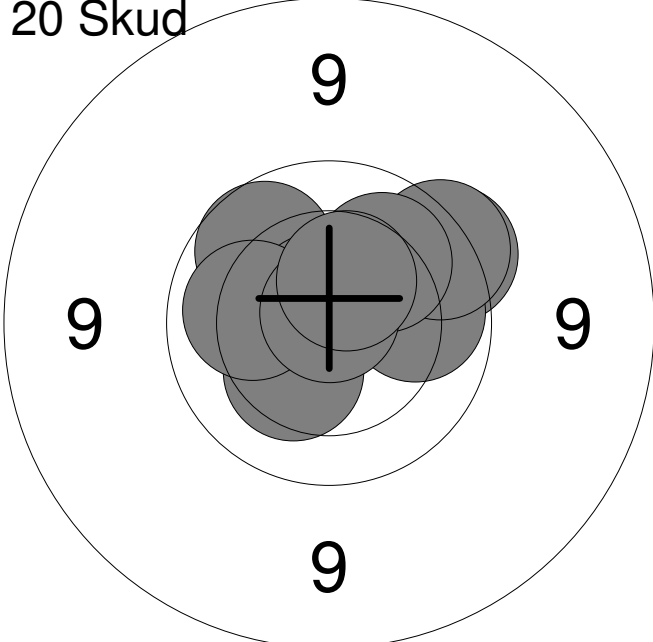
<b>20 Skud</b> 	1:	9.9	↗
	2:	9.7	→
	3:	10.0	→
	4:	10.3	↙
	5:	9.7	↗
	6:	10.7x	↑
	7:	10.1	←
	8:	10.1	↗
	9:	10.8x	↑
	10:	10.5	↗
	<b>Serie</b>		<b>97.0</b>
<b>Total</b>		<b>97.0</b>	

<b>20 Skud</b> 	11:	9.8	↗
	12:	10.3	↙
	13:	10.0	→
	14:	10.3	↓
	15:	9.9	↑
	16:	10.3	↙
	17:	10.4	↘
	18:	10.2	↗
	19:	10.2	↓
	20:	10.3	→
	<b>Serie</b>		<b>98.0</b>
<b>Total</b>		<b>195.0</b>	

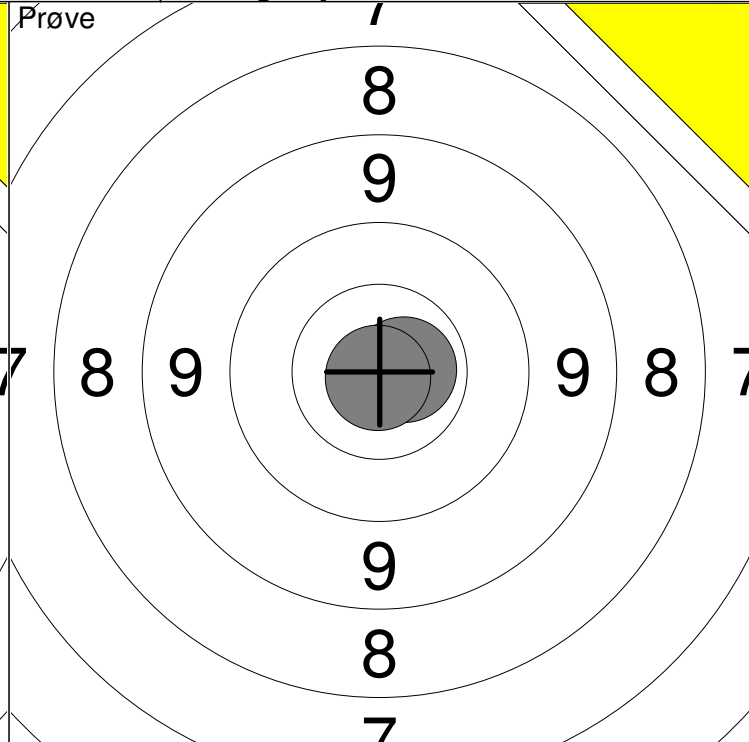
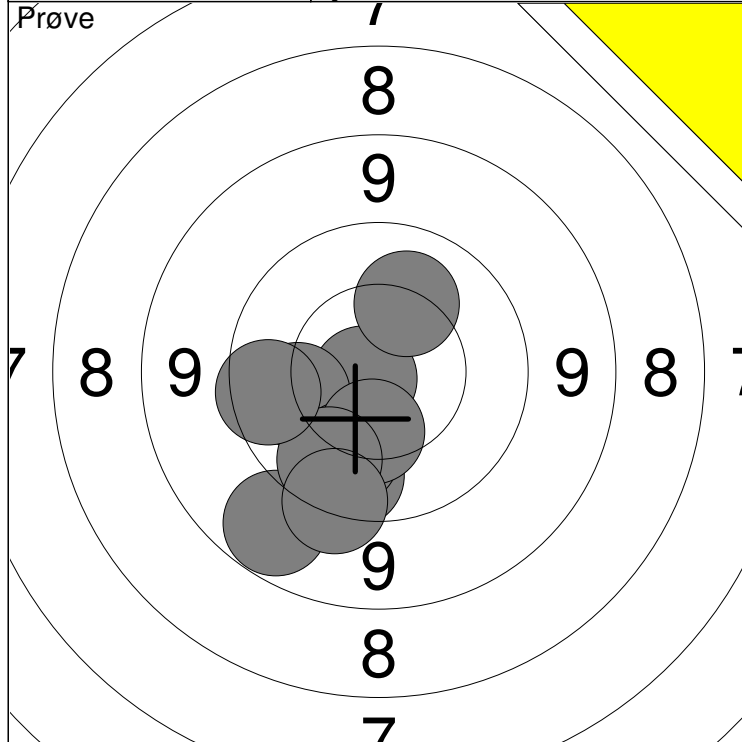

1: 9.0 ↘	6: 10.0 ↓	Serie	95
2: 9.8 ↓	7: 10.3 ↓		
3: 10.8x ←	8: 9.9 ↓		
4: 10.1 ←	9: 9.8 ←		
5: 10.2 ↗	10: 9.5 ↓		
		Total	0

11: 10.7x →	Serie	20	
12: 10.9x ↓			
		Total	0

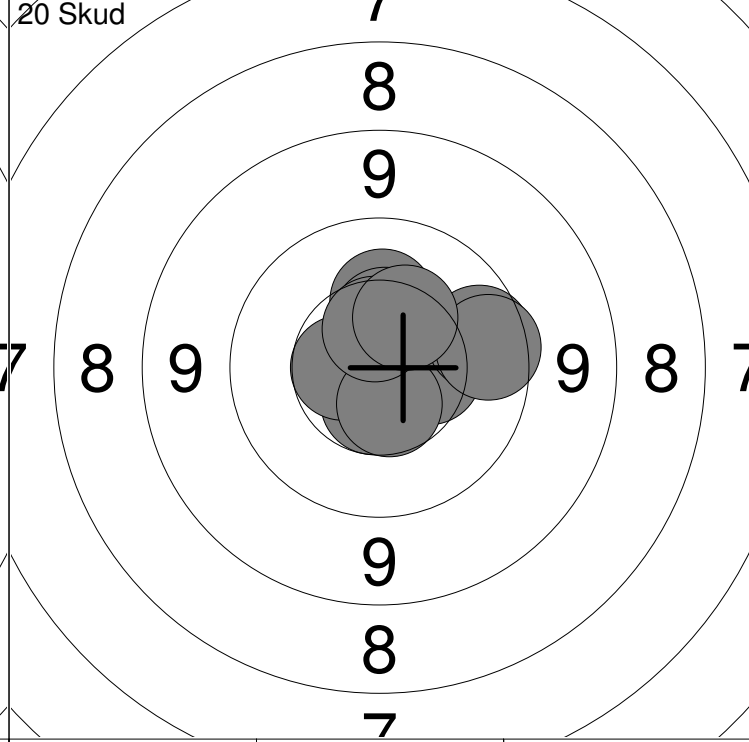
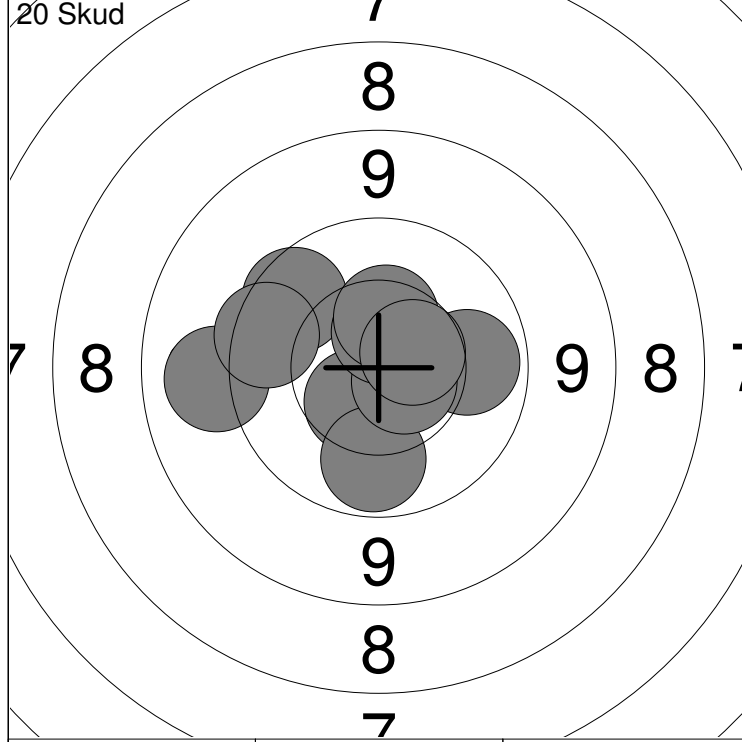

1: 9.2 ←	6: 10.0 ↓	Serie	97
2: 9.8 ↗	7: 10.7x →		
3: 9.7 ←	8: 10.6 ↑		
4: 10.0 →	9: 10.4 ↑		
5: 10.5 ↘	10: 10.6 →		
		Total	97

11: 10.3 ↑	16: 10.6 ↓	Serie	98
12: 10.5 ↑	17: 10.5 ↑		
13: 10.6x ↓	18: 9.9 →		
14: 10.6 ←	19: 9.8 →		
15: 10.4 →	20: 10.4 ↗		
		Total	195

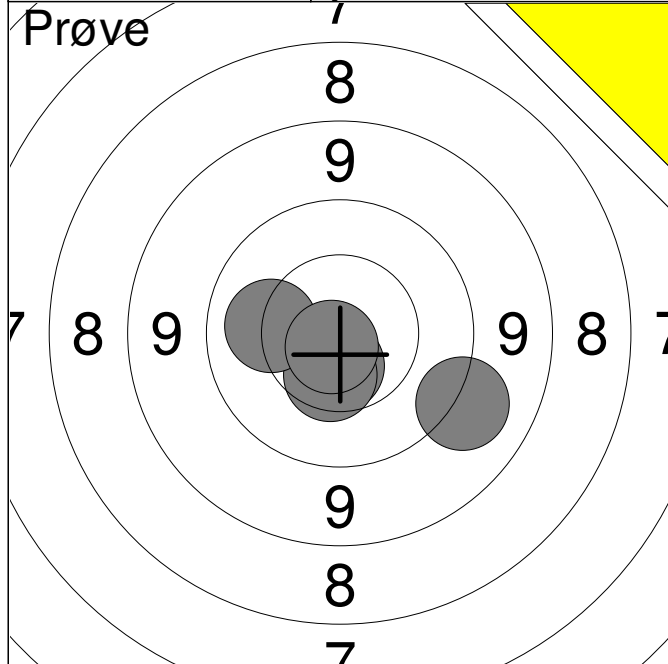

1:	10.6	↓
2:	10.5	↓
3:	9.3	→
4:	10.2	←
5:	10.8x	↙
<b>Serie</b>	<b>49.0</b>	
<b>Total</b>	<b>0.0</b>	

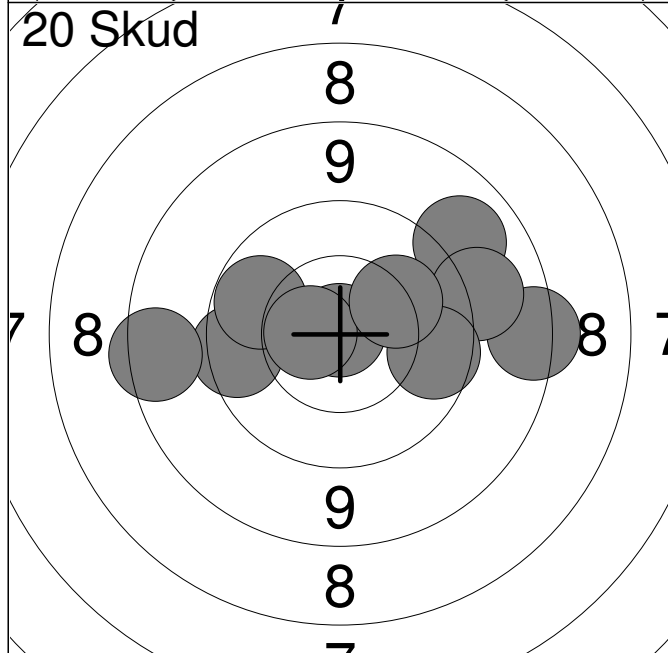

1:	9.7	←
2:	8.6	→
3:	8.7	←
4:	10.0	↖
5:	10.9x	↑
6:	9.1	↗
7:	10.6x	←
8:	9.2	→
9:	9.8	→
10:	10.2	↗
<b>Serie</b>	<b>92.0</b>	
<b>Total</b>	<b>92.0</b>	

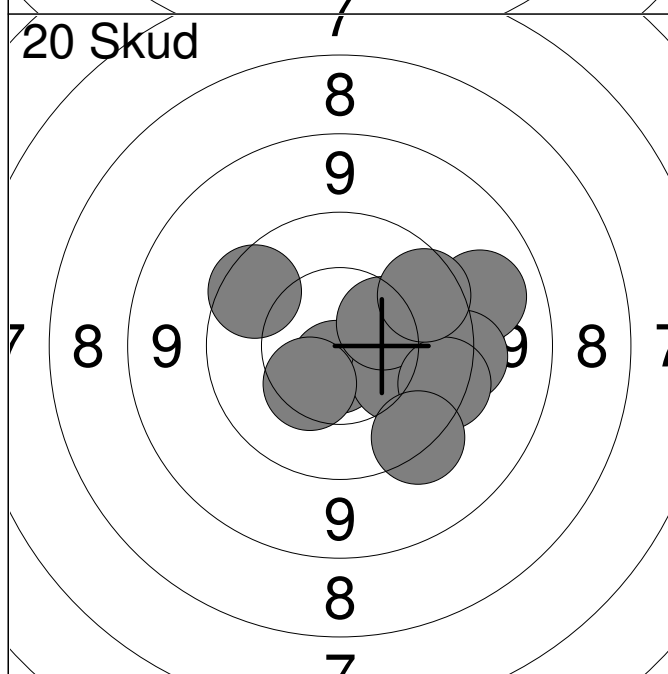

11:	9.2	→
12:	10.7x	↓
13:	9.8	↖
14:	10.2	→
15:	10.4	↙
16:	9.5	→
17:	10.4	↗
18:	9.6	→
19:	9.8	↗
20:	9.5	↙
<b>Serie</b>	<b>94.0</b>	
<b>Total</b>	<b>186.0</b>	



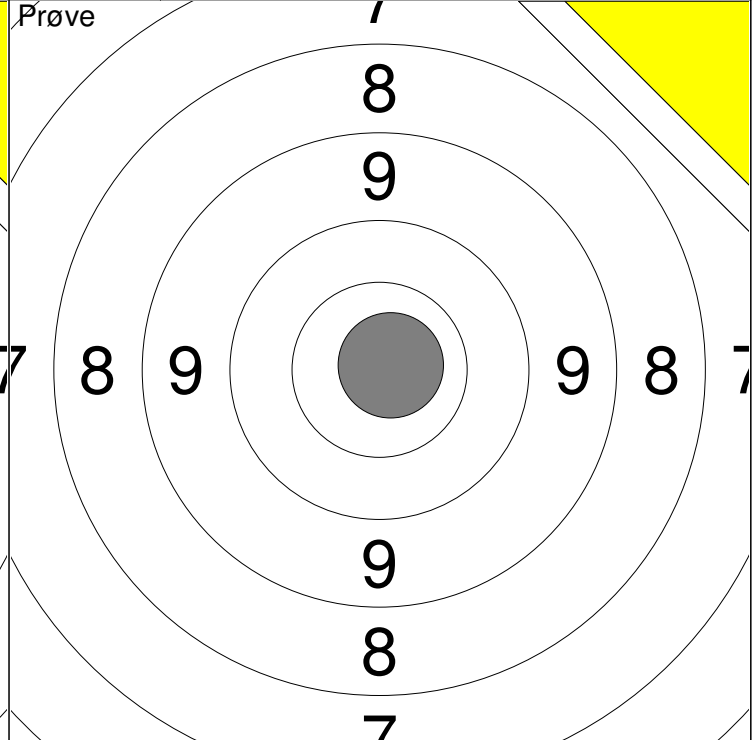
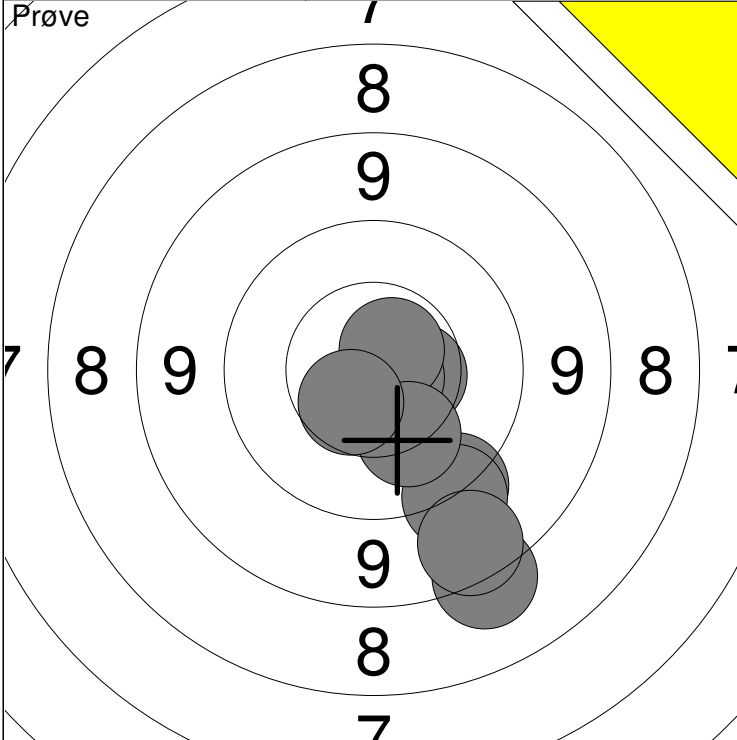

1: 9.4 ↙	6: 10.7x →	Serie	94
2: 8.4 ↙	7: 10.6 ↙		
3: 9.3 ↙	8: 10.7x ↗	Total	0
4: 8.8 ↙	9: 10.2 ↙		
5: 10.5 →	10: 10.5 ↙		

11: 10.8x →	Serie	10
	Total	0

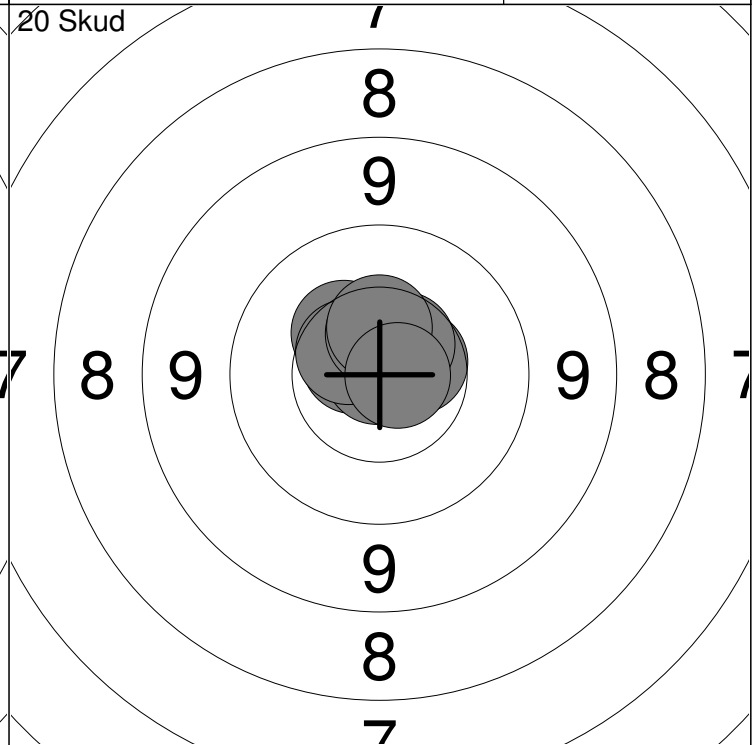
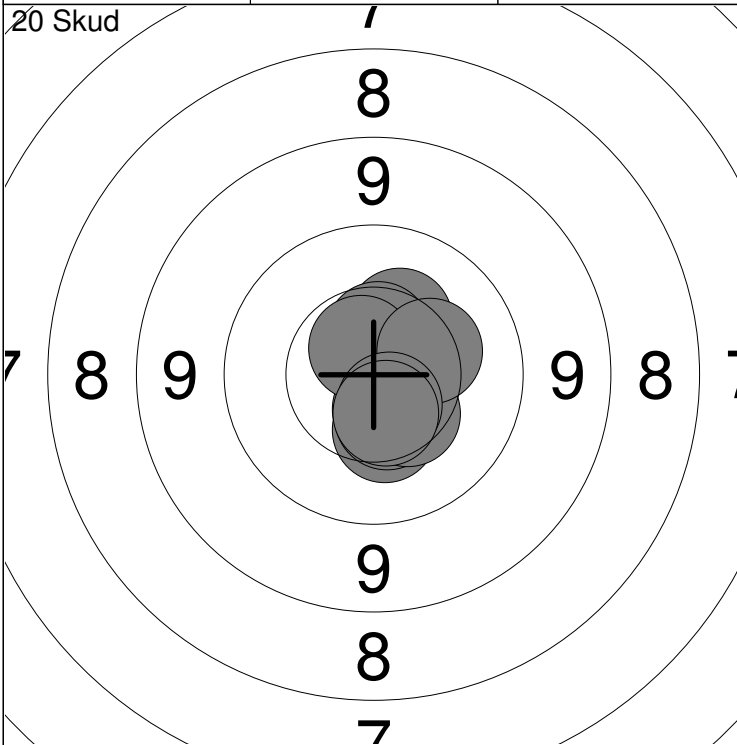

1: 10.6 ↙	6: 10.5 ↑	Serie	100
2: 10.4 ↙	7: 10.7x ↗		
3: 10.5 ↙	8: 10.3 →	Total	100
4: 10.4 ↙	9: 10.6x ↙		
5: 10.3 ↗	10: 10.5 ↙		

11: 10.6 →	16: 10.6 ↖	Serie	100
12: 10.4 ↖	17: 10.6 ↗		
13: 10.9x ↗	18: 10.5 ↑	Total	200
14: 10.7x ↖	19: 10.5 ↑		
15: 10.9x ↗	20: 10.8x →		

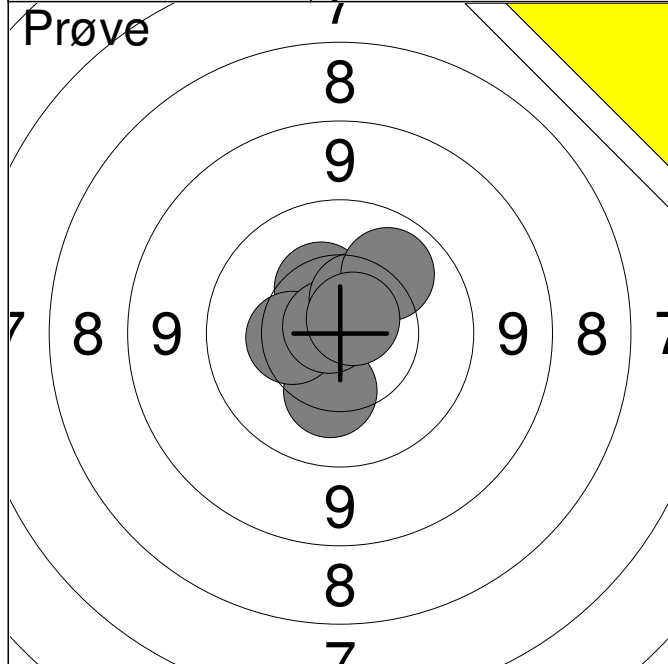

1:	10.3	↓
2:	10.4	↑
3:	10.4	←
4:	10.8x	↗
5:	10.5	↑
6:	10.1	↗
7:	10.7x	↗
<b>Serie</b>		<b>70.0</b>
<b>Total</b>		<b>0.0</b>

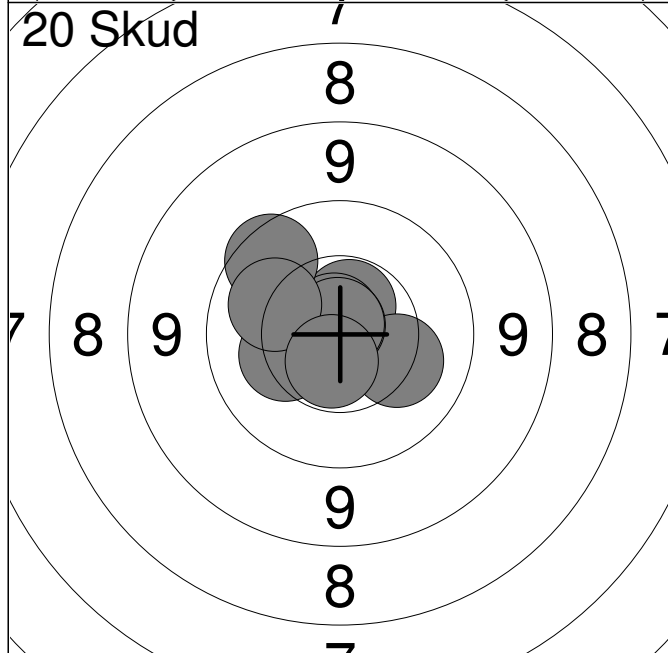

1:	10.6x	↑
2:	10.2	→
3:	10.3	←
4:	10.8x	↑
5:	9.8	↗
6:	10.8x	←
7:	10.8x	↑
8:	10.8x	↑
9:	10.1	↗
10:	10.6x	↓
<b>Serie</b>		<b>99.0</b>
<b>Total</b>		<b>99.0</b>

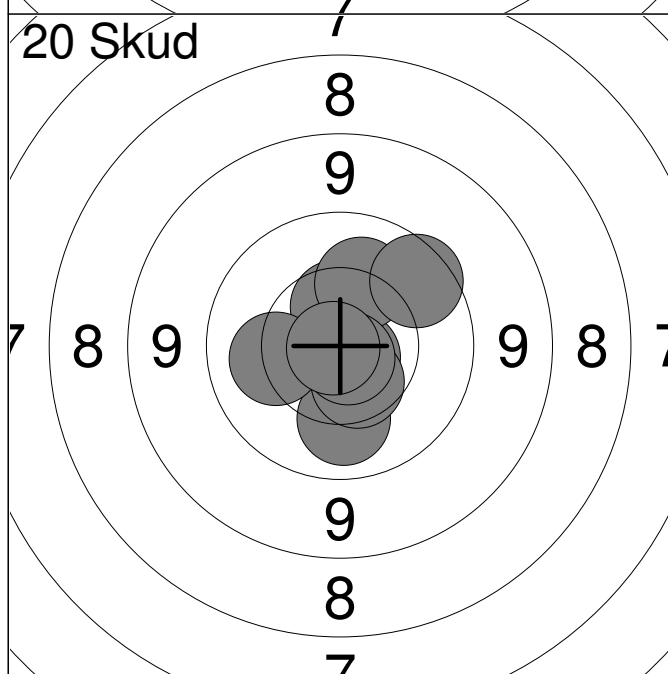

11:	10.8x	↓
12:	10.5	↑
13:	10.7x	↓
14:	10.1	↓
15:	10.2	←
16:	10.2	↑
17:	10.5	↓
18:	10.8x	↓
19:	10.9x	←
20:	9.8	↗
<b>Serie</b>		<b>99.0</b>
<b>Total</b>		<b>198.0</b>

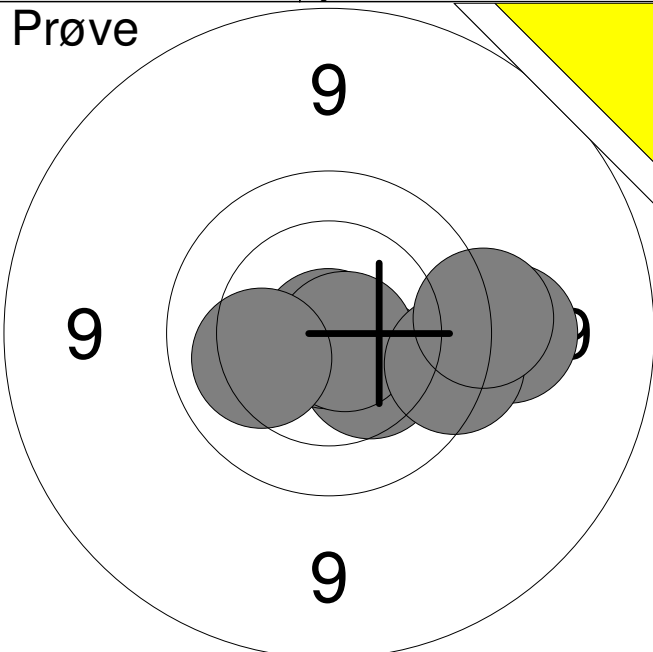
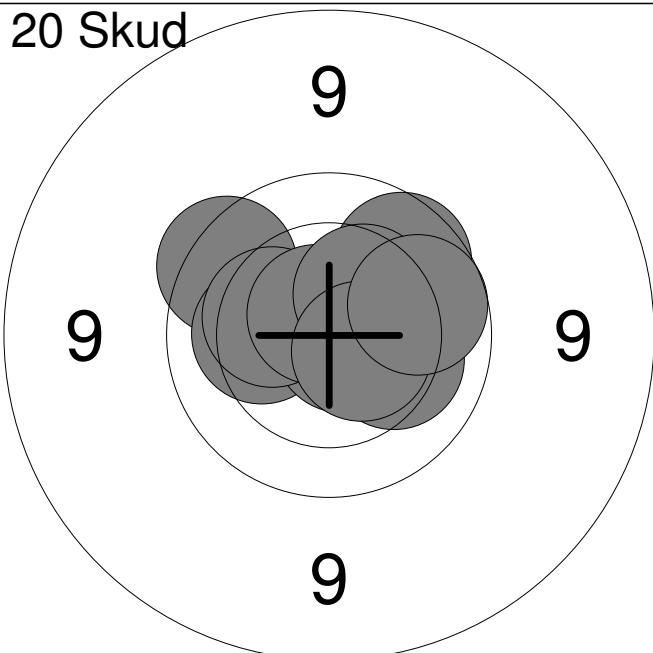
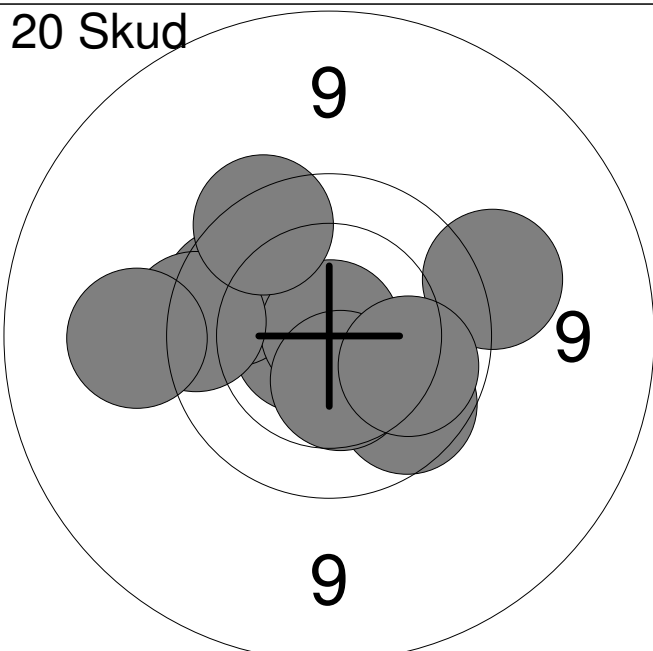
Hold	Skive	Mikkel Larsen		
20	10	Vodskov Skytteforening	MB3	
15m				
11.02.2015	Jyllandsstævne 2015	Aalborg Skyttekreds		
Prøve		1: 10.4	↘	
		2: 9.4	→	
		3: 10.9x	↘	
		4: 10.8x	↘	
		5: 9.7	→	
		6: 9.6	→	
		7: 10.2	←	
		<b>Serie</b>	<b>67.0</b>	
		<b>Total</b>	<b>0.0</b>	
20 Skud		1: 9.8	↗	
		2: 10.2	←	
		3: 10.8x	↘	
		4: 9.9	↗	
		5: 10.2	→	
		6: 10.3	↖	
		7: 10.7x	↗	
		8: 10.4	↗	
		9: 10.6x	↘	
		10: 9.9	→	
		<b>Serie</b>	<b>97.0</b>	
		<b>Total</b>	<b>97.0</b>	
20 Skud		11: 10.7x	←	
		12: 9.9	↘	
		13: 9.9	↖	
		14: 10.9x	↗	
		15: 9.5	→	
		16: 9.7	←	
		17: 10.5	↘	
		18: 10.0	↘	
		19: 9.7	↗	
		20: 9.3	←	
		<b>Serie</b>	<b>94.0</b>	
		<b>Total</b>	<b>191.0</b>	

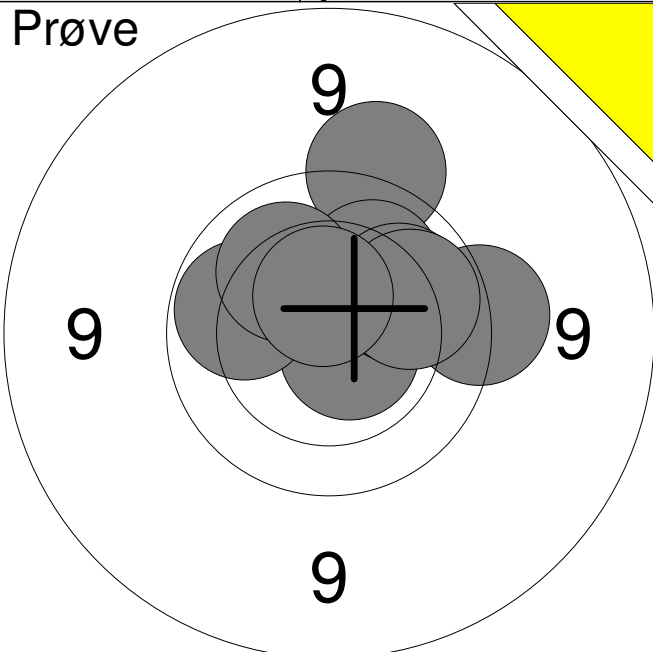
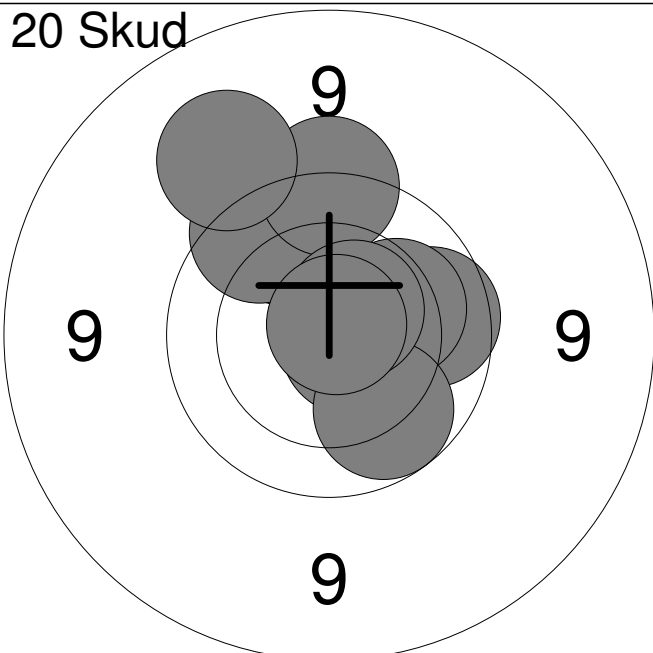
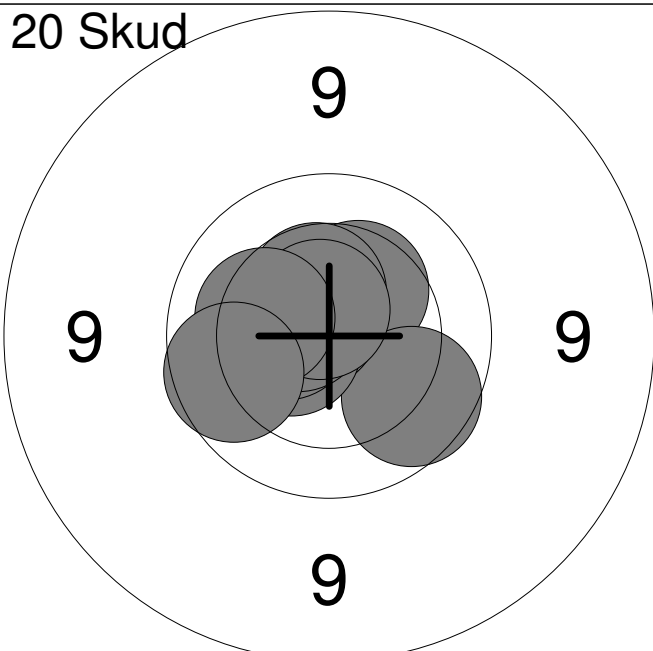
Hold	Skive	Sebastian C. Bonde	
20	11	Vodskov Skytteforening	MB3
15m			
11.02.2015	Jyllandsstævne 2015	Aalborg Skyttekreds	
Prøve		1: 10.7x ↘ 2: 10.0 ← 3: 9.5 ↑ 4: 9.6 → 5: 10.1 ↗ 6: 10.1 ↑ 7: 10.1 ↗ 8: 10.0 → 9: 10.5x ↑	
		Serie	88.0
		Total	0.0
20 Skud		1: 9.9 → 2: 9.9 ↑ 3: 9.8 ↗ 4: 9.6 ↑ 5: 10.7x → 6: 10.2 → 7: 10.0 ↓ 8: 10.6x ↗ 9: 10.8x ↗ 10: 9.3 ↑	
		Serie	95.0
		Total	95.0
20 Skud		11: 10.4 ↗ 12: 9.9 ↓ 13: 10.7x ↗ 14: 10.5x ← 15: 10.5 ← 16: 10.5 ↑ 17: 10.6x ↗ 18: 10.6x ↑ 19: 10.2 ← 20: 9.9 ←	
		Serie	98.0
		Total	193.0

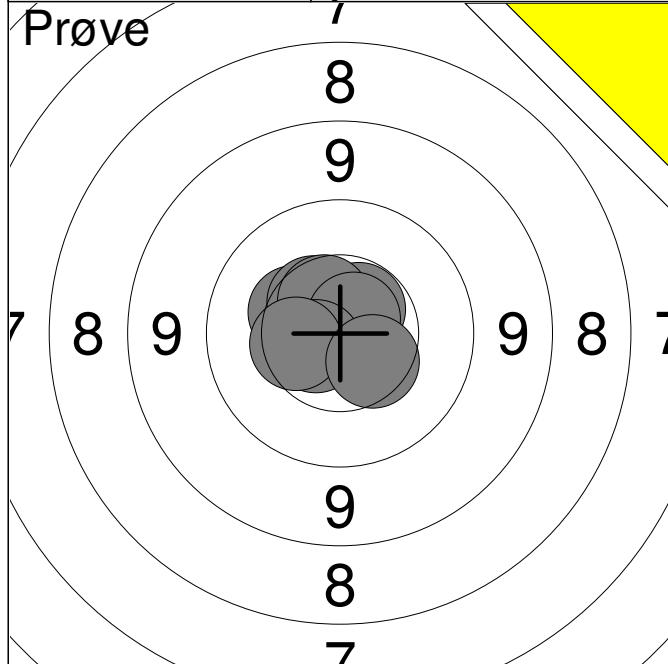

1:	10.6x	↗
2:	10.4	↖
3:	10.5	↗
4:	10.5	↗
5:	10.7x	↗
6:	10.6x	↖
7:	10.4	↖
8:	10.5	↘
<b>Serie</b>		<b>80.0</b>
<b>Total</b>		<b>0.0</b>

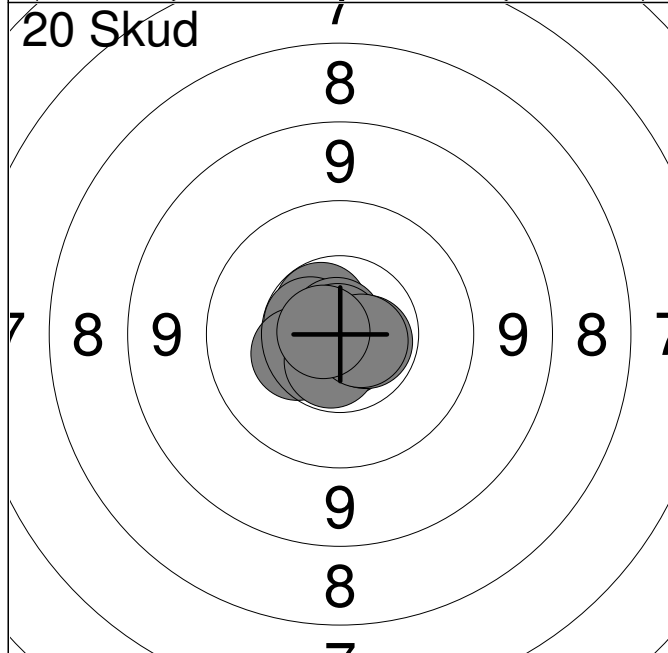

1:	10.6x	↗
2:	10.8x	↘
3:	10.6x	↗
4:	10.4	↖
5:	10.8x	↗
6:	10.9x	↗
7:	10.6x	↘
8:	10.6x	↘
9:	10.7x	↘
10:	10.8x	↖
<b>Serie</b>		<b>100.0</b>
<b>Total</b>		<b>100.0</b>

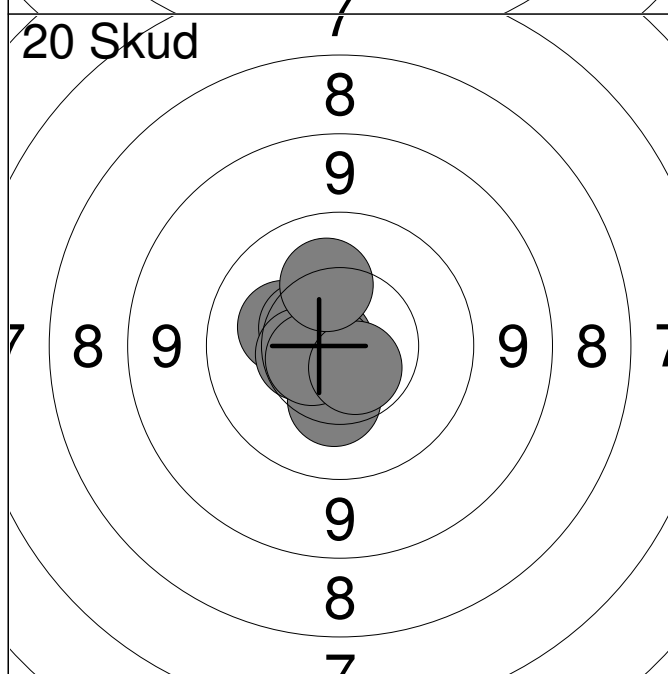

11:	10.4	↖
12:	10.3	↖
13:	10.3	↘
14:	10.8x	↖
15:	10.5	↗
16:	10.5	↖
17:	10.8x	↖
18:	10.6x	↖
19:	10.6x	↘
20:	10.2	↗
<b>Serie</b>		<b>100.0</b>
<b>Total</b>		<b>200.0</b>

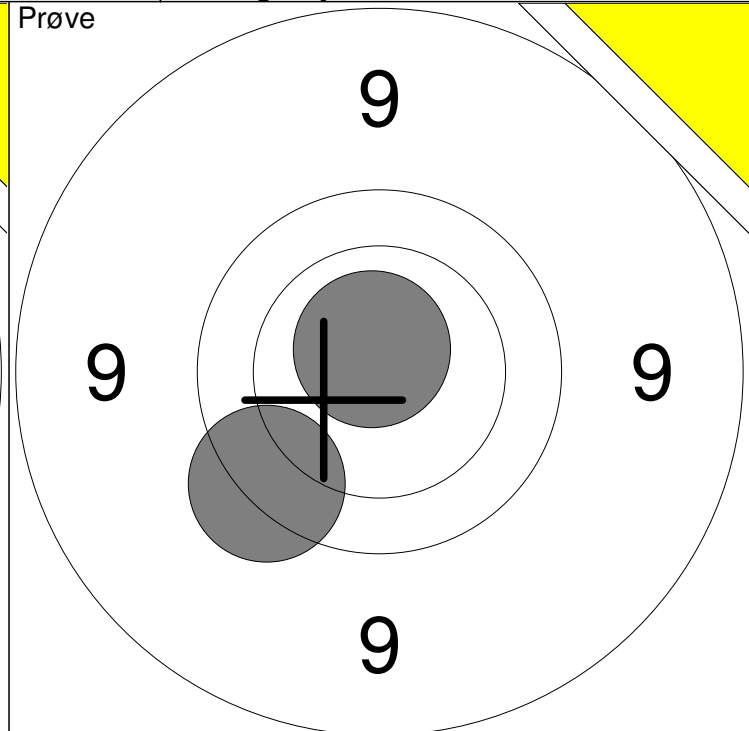
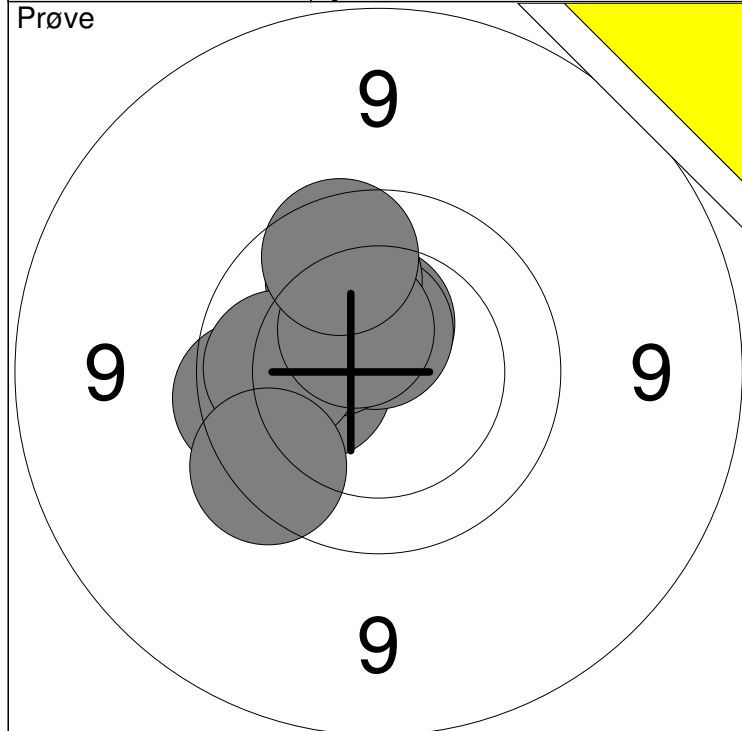

1: 10.3 ←	6: 10.4 ↗	Serie	97
2: 9.8 ←	7: 10.0 ←		
3: 10.5 ↑	8: 9.7 ↘	Total	0
4: 10.6x ↑	9: 10.5 ↗		
5: 10.0 ↗	10: 9.9 ↗		

11: 9.6 ↙	Serie	19
12: 10.7x ↗		
Total		0

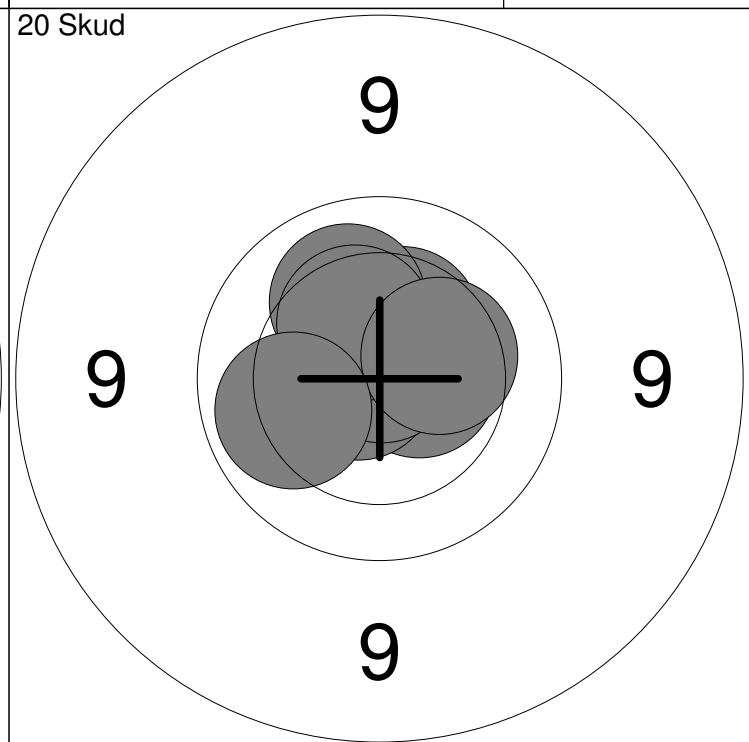
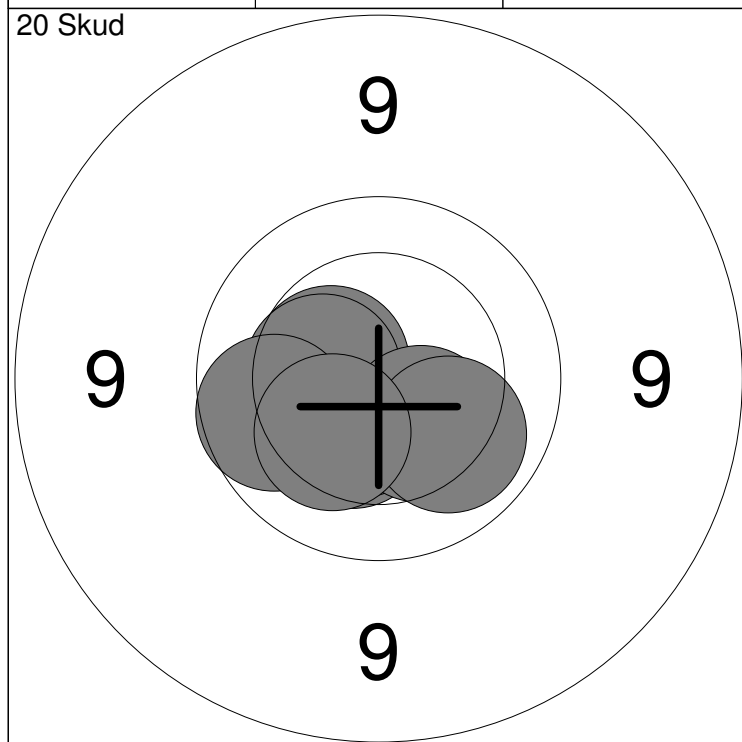

1: 10.6x ←	6: 10.4 ←	Serie	99
2: 10.6x ↓	7: 9.9 ←		
3: 10.4 ↓	8: 10.4 ↓	Total	99
4: 10.5 ←	9: 10.1 ↓		
5: 10.5x ↓	10: 10.3 ↘		

11: 10.8x ↗	16: 10.2 ↗	Serie	100
12: 10.6x →	17: 10.8x ↑		
13: 10.6x ↗	18: 10.4 ↗	Total	199
14: 10.7x ←	19: 10.3 →		
15: 10.4 ↗	20: 10.1 ←		

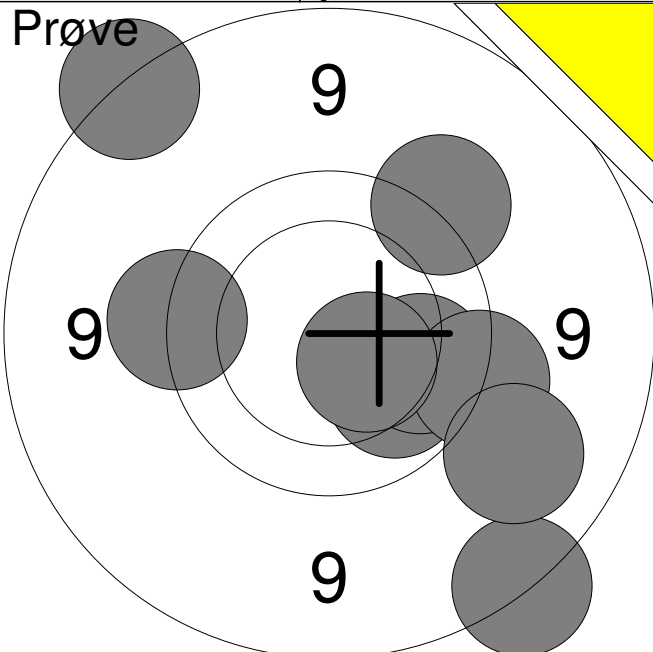
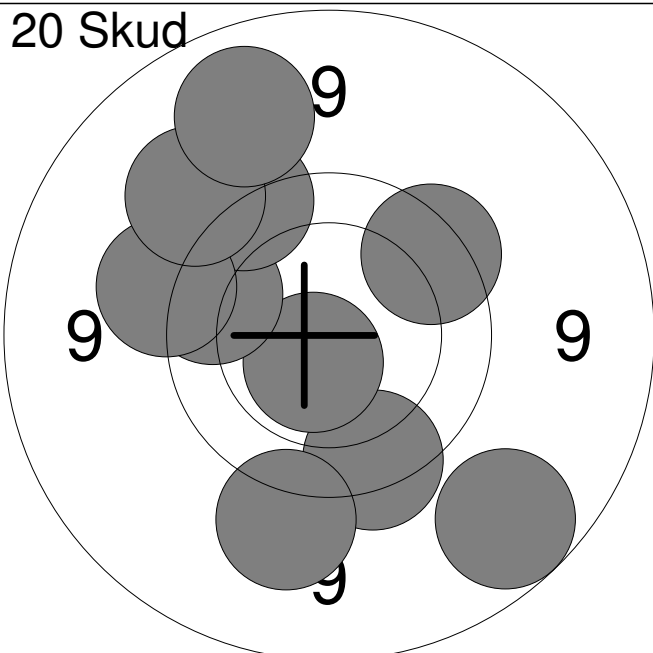
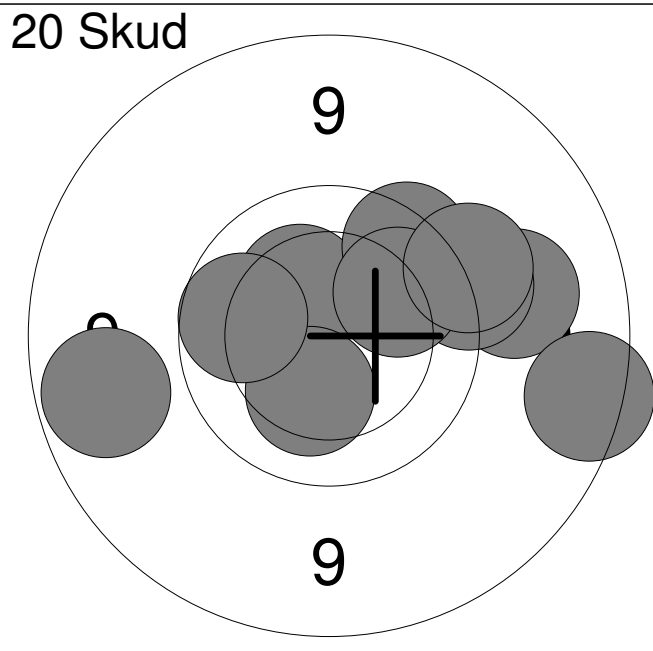
Hold <b>21</b>	Skive <b>2</b>	<b>Morten Larsen</b>	
15m	Vester Hassing Skf.		2
11.02.2015	Jyllandsstævne 2015	Aalborg Skyttekreds	
<b>Prøve</b> 	1: 8.7	↗	
	2: 8.7	↘	
	3: 10.0	↘	
	4: 9.9	→	
	5: 9.5	→	
	6: 9.2	↘	
	7: 9.5	↗	
	8: 9.6	←	
	9: 10.4	↘	
	<b>Serie</b>	<b>81.0</b>	
	<b>Total</b>	<b>0.0</b>	
<b>20 Skud</b> 	1: 9.7	↘	
	2: 9.0	↘	
	3: 9.4	↘	
	4: 10.6x	↘	
	5: 9.8	↗	
	6: 9.5	↗	
	7: 9.5	↗	
	8: 9.7	↗	
	9: 9.3	↗	
	10: 9.1	↗	
	<b>Serie</b>	<b>91.0</b>	
	<b>Total</b>	<b>91.0</b>	
<b>20 Skud</b> 	11: 10.3	↗	
	12: 9.3	→	
	13: 9.0	←	
	14: 10.3	↘	
	15: 9.5	→	
	16: 9.7	↗	
	17: 10.0	↗	
	18: 9.9	←	
	19: 8.8	→	
	20: 9.5	↗	
	<b>Serie</b>	<b>92.0</b>	
	<b>Total</b>	<b>183.0</b>	

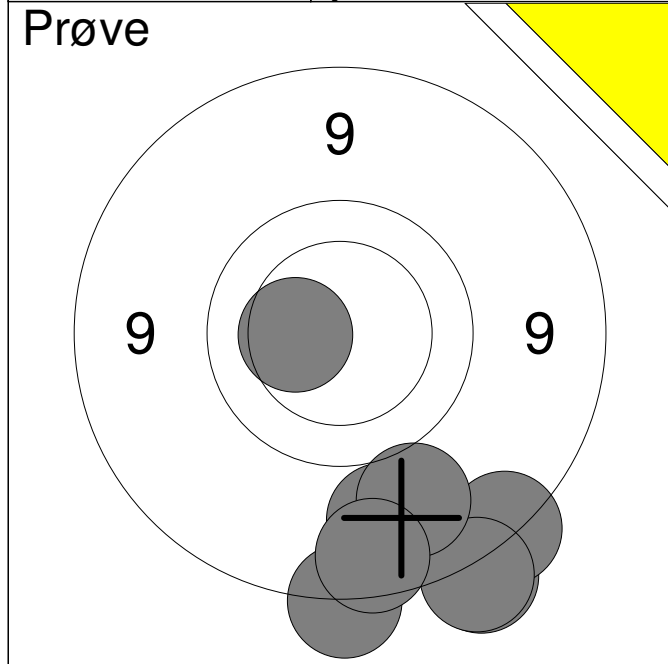

1:	10.4	←
2:	8.6	↘
3:	9.1	↘
4:	8.7	↘
5:	8.7	↘
6:	8.6	↘
7:	9.1	↘
8:	8.9	↘
<b>Serie</b>		<b>68.0</b>
<b>Total</b>		<b>0.0</b>

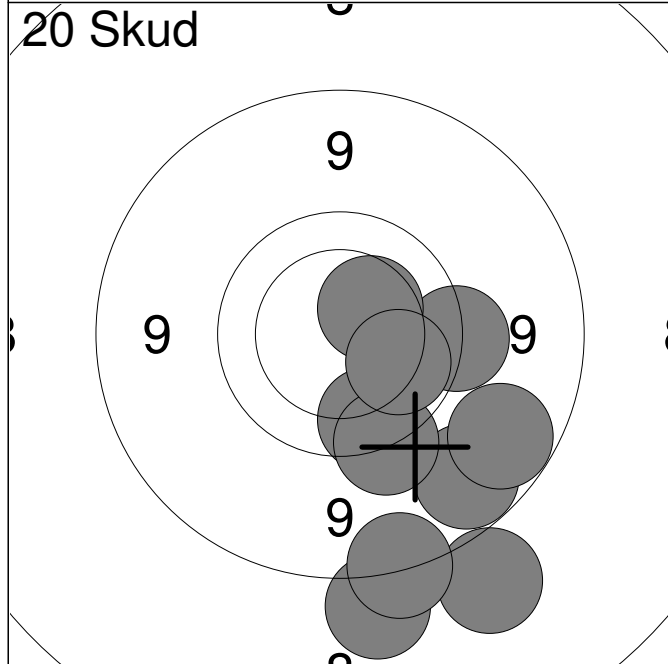

1:	8.4	↘
2:	8.5	↘
3:	8.7	↘
4:	9.0	↘
5:	9.8	↘
6:	9.0	↘
7:	9.6	→
8:	10.4	↗
9:	9.6	↘
10:	10.0	↘
<b>Serie</b>		<b>89.0</b>
<b>Total</b>		<b>89.0</b>

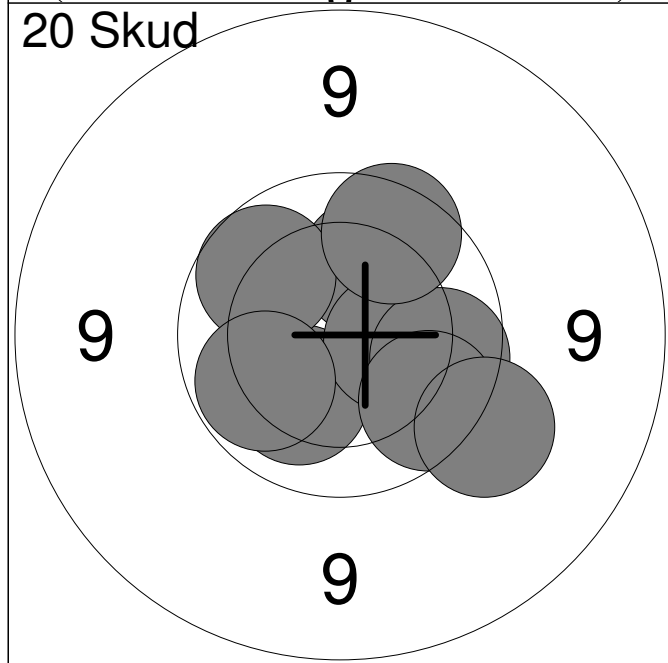

11:	10.1	↗
12:	10.2	↘
13:	10.4	→
14:	9.9	↗
15:	9.8	↘
16:	9.9	→
17:	9.8	↗
18:	10.0	↘
19:	9.8	↘
20:	9.5	↘
<b>Serie</b>		<b>94.0</b>
<b>Total</b>		<b>183.0</b>

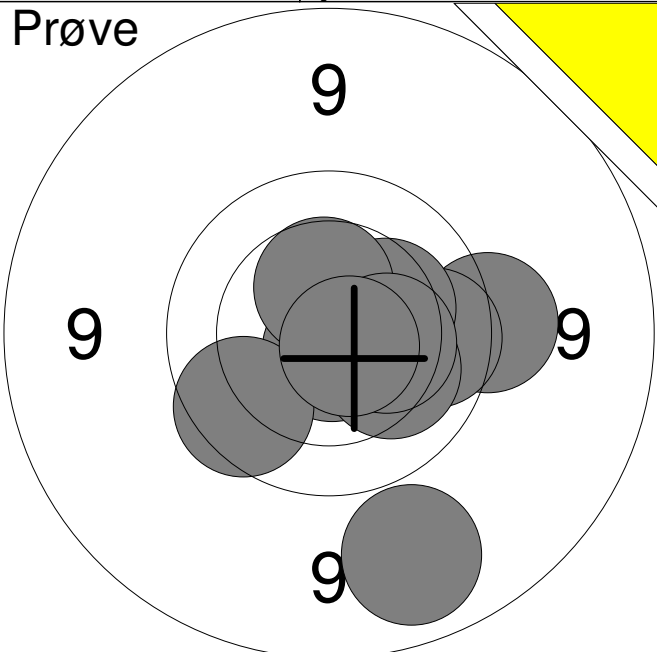
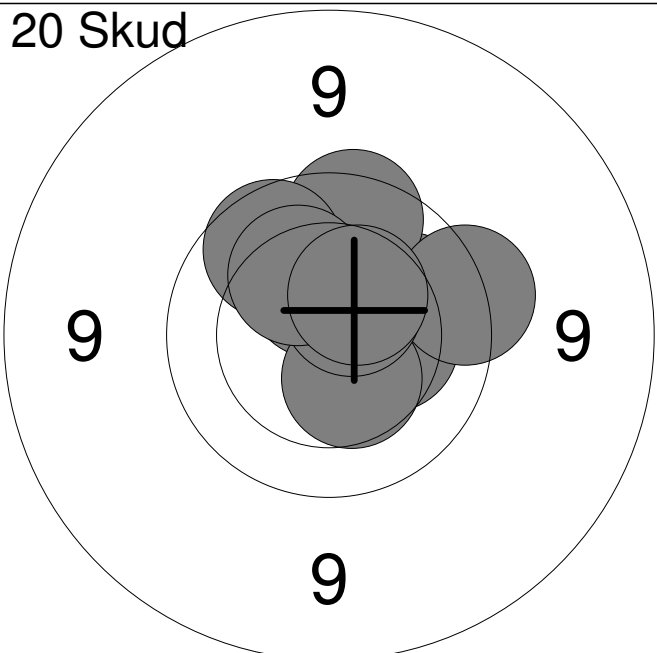
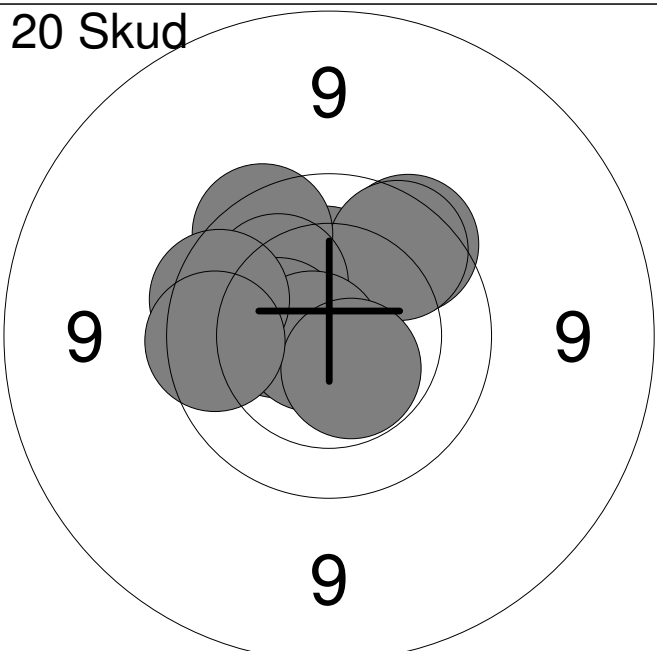

Hold <b>21</b>	Skive <b>4</b>	<b>Jon Jensen</b>	
15m	Mou & Omegns Skf.	BK3	
11.02.2015	Jyllandsstævne 2015	Aalborg Skyttekreds	
<b>Prøve</b> 	1:	9.1	↓
	2:	9.5	→
	3:	10.8x	↓
	4:	9.9	→
	5:	10.3	→
	6:	10.4	↑
	7:	9.8	↙
	8:	10.2	↓
	9:	10.3	→
	10:	10.7x	↓
	<b>Serie</b>		<b>96.0</b>
<b>Total</b>		<b>0.0</b>	
<b>20 Skud</b> 	1:	10.0	→
	2:	10.3	→
	3:	10.4	↑
	4:	9.8	↑
	5:	9.9	↑
	6:	9.6	→
	7:	10.4	↓
	8:	10.6x	↗
	9:	10.2	↑
	10:	10.4	↗
	<b>Serie</b>		<b>97.0</b>
<b>Total</b>		<b>97.0</b>	
<b>20 Skud</b> 	11:	10.3	↑
	12:	9.8	↗
	13:	9.8	↗
	14:	9.8	↑
	15:	10.2	↗
	16:	10.4	←
	17:	10.8x	↙
	18:	9.8	←
	19:	10.5x	↓
	20:	9.8	←
	<b>Serie</b>		<b>95.0</b>
<b>Total</b>		<b>192.0</b>	

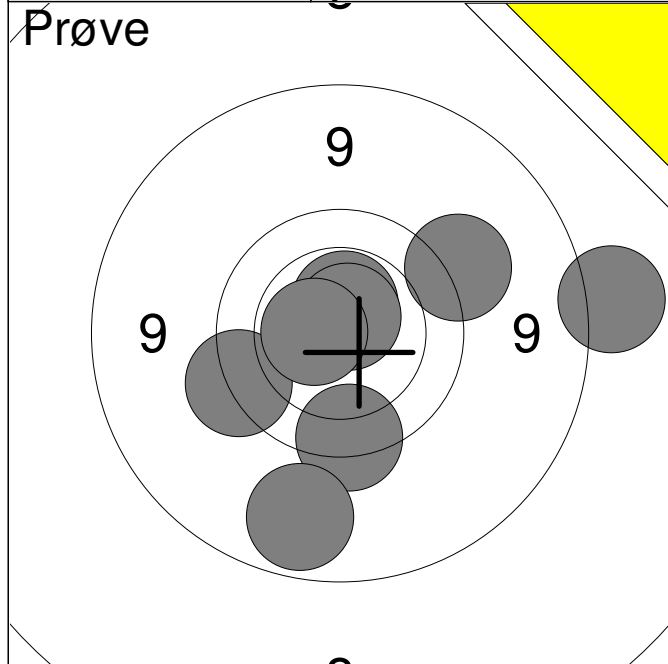

1:	9.4	↗
2:	10.5x	↑
3:	9.7	↓
4:	8.5	→
5:	9.0	↓
6:	9.6	↙
7:	10.7x	↑
8:	10.6x	←
<b>Serie</b>		<b>74.0</b>
<b>Total</b>		<b>0.0</b>

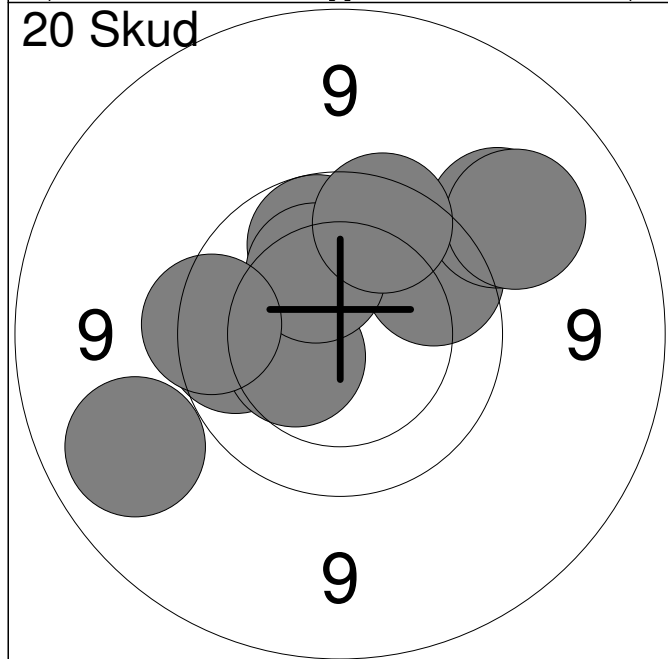

1:	9.8	↗
2:	9.9	←
3:	9.3	↗
4:	10.0	↑
5:	10.4	↙
6:	10.2	↑
7:	9.2	↗
8:	9.1	↙
9:	9.7	←
10:	9.8	↑
<b>Serie</b>		<b>93.0</b>
<b>Total</b>		<b>93.0</b>

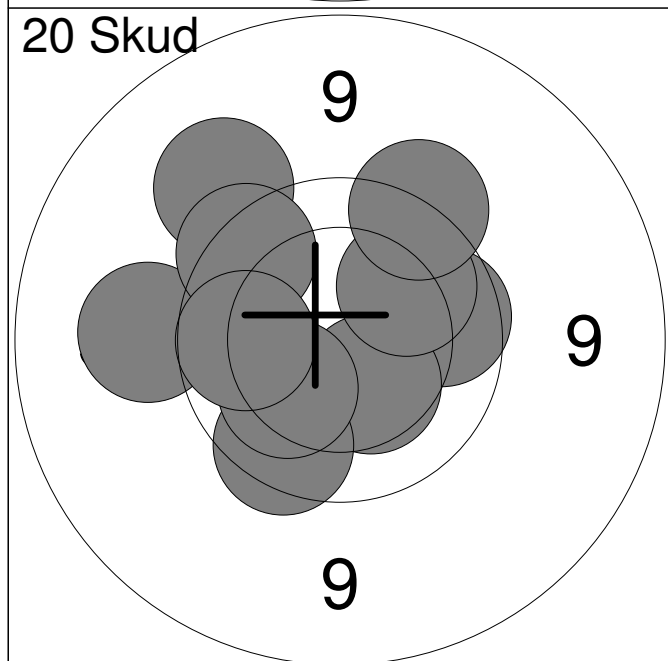

11:	9.3	↗
12:	9.3	←
13:	9.9	→
14:	9.7	↗
15:	10.4	↓
16:	10.0	↗
17:	9.8	↓
18:	10.2	↙
19:	9.9	←
20:	9.6	↗
<b>Serie</b>		<b>93.0</b>
<b>Total</b>		<b>186.0</b>

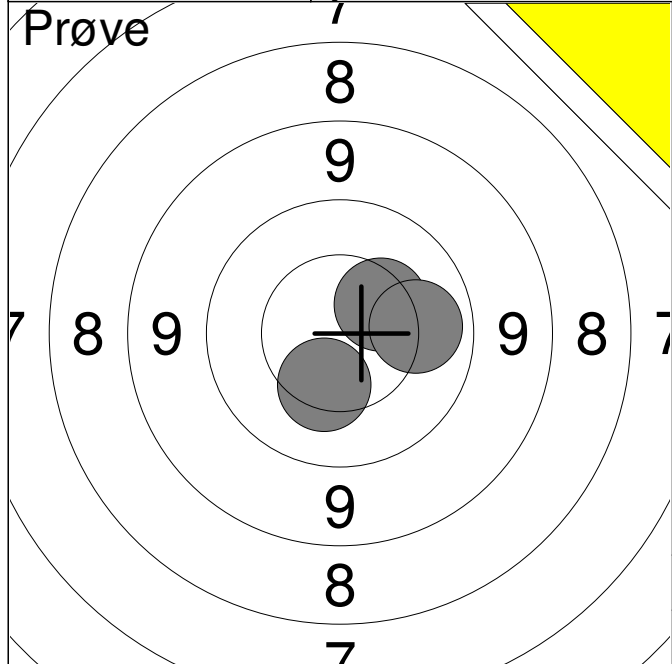

1:	10.3	↓
2:	10.4	↗
3:	10.1	→
<b>Serie</b>		<b>30.0</b>
<b>Total</b>		<b>0.0</b>

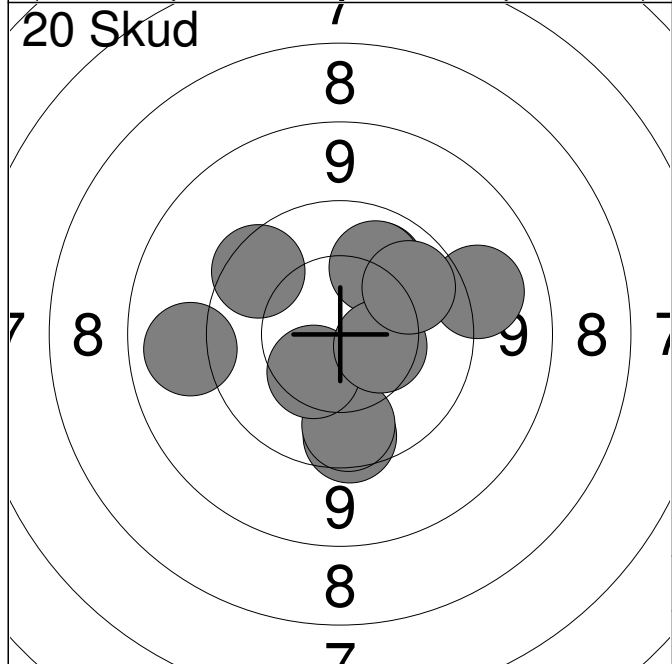

1:	9.1	←
2:	9.7	↓
3:	10.1	↗
4:	9.9	↓
5:	10.4	↙
6:	10.1	↗
7:	9.7	↗
8:	9.2	→
9:	10.5	→
10:	10.0	↗
<b>Serie</b>		<b>95.0</b>
<b>Total</b>		<b>95.0</b>

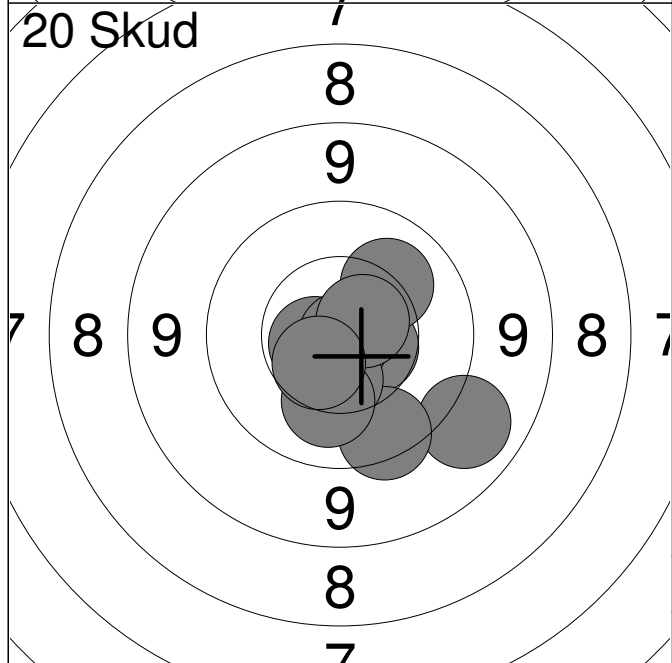

11:	10.6	→
12:	10.2	↗
13:	10.6x	←
14:	9.1	↓
15:	10.9x	↓
16:	9.7	↓
17:	10.4	↓
18:	10.2	↓
19:	10.6x	↗
20:	10.5	↙
<b>Serie</b>		<b>98.0</b>
<b>Total</b>		<b>193.0</b>

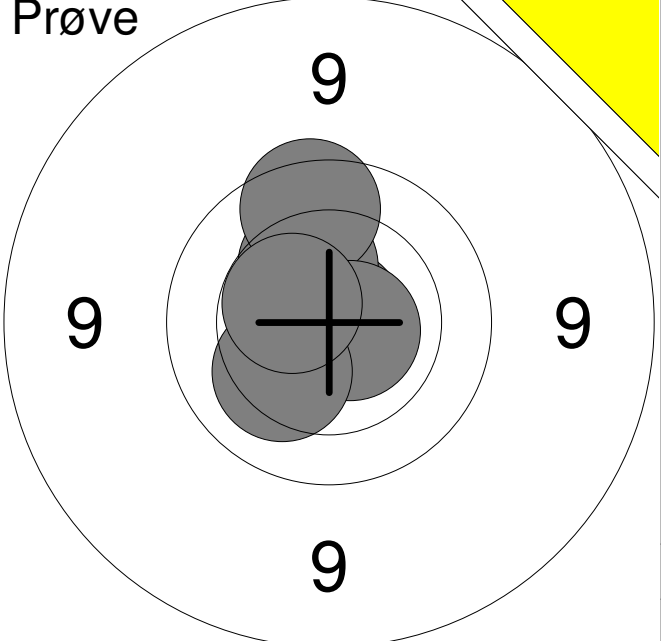
<p><b>Prøve</b></p> 	<table style="width:100%; border-collapse: collapse;"> <tr><td style="width:10%;">1:</td><td style="width:80%;">10.9x</td><td style="width:10%; text-align: right;">↗</td></tr> <tr><td>2:</td><td>10.3</td><td style="text-align: right;">↑</td></tr> <tr><td>3:</td><td>9.8</td><td style="text-align: right;">↑</td></tr> <tr><td>4:</td><td>10.7x</td><td style="text-align: right;">↘</td></tr> <tr><td>5:</td><td>10.2</td><td style="text-align: right;">↙</td></tr> <tr><td>6:</td><td>10.5x</td><td style="text-align: right;">↖</td></tr> </table>	1:	10.9x	↗	2:	10.3	↑	3:	9.8	↑	4:	10.7x	↘	5:	10.2	↙	6:	10.5x	↖
1:	10.9x	↗																	
2:	10.3	↑																	
3:	9.8	↑																	
4:	10.7x	↘																	
5:	10.2	↙																	
6:	10.5x	↖																	
<table style="width:100%; border-collapse: collapse;"> <tr> <td style="width:80%;"><b>Serie</b></td> <td style="text-align: right;"><b>59.0</b></td> </tr> <tr> <td><b>Total</b></td> <td style="text-align: right;"><b>0.0</b></td> </tr> </table>		<b>Serie</b>	<b>59.0</b>	<b>Total</b>	<b>0.0</b>														
<b>Serie</b>	<b>59.0</b>																		
<b>Total</b>	<b>0.0</b>																		

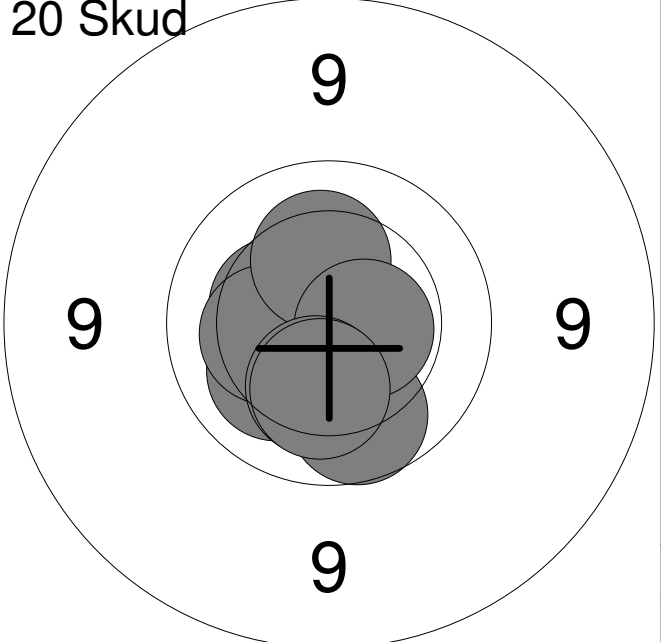
<p><b>20 Skud</b></p> 	<table style="width:100%; border-collapse: collapse;"> <tr><td style="width:10%;">1:</td><td style="width:80%;">10.6x</td><td style="width:10%; text-align: right;">↓</td></tr> <tr><td>2:</td><td>10.4</td><td style="text-align: right;">←</td></tr> <tr><td>3:</td><td>9.9</td><td style="text-align: right;">↓</td></tr> <tr><td>4:</td><td>10.2</td><td style="text-align: right;">↙</td></tr> <tr><td>5:</td><td>10.8x</td><td style="text-align: right;">↙</td></tr> <tr><td>6:</td><td>10.3</td><td style="text-align: right;">←</td></tr> <tr><td>7:</td><td>10.3</td><td style="text-align: right;">↑</td></tr> <tr><td>8:</td><td>10.6x</td><td style="text-align: right;">→</td></tr> <tr><td>9:</td><td>10.3</td><td style="text-align: right;">↓</td></tr> <tr><td>10:</td><td>10.2</td><td style="text-align: right;">↓</td></tr> </table>	1:	10.6x	↓	2:	10.4	←	3:	9.9	↓	4:	10.2	↙	5:	10.8x	↙	6:	10.3	←	7:	10.3	↑	8:	10.6x	→	9:	10.3	↓	10:	10.2	↓
1:	10.6x	↓																													
2:	10.4	←																													
3:	9.9	↓																													
4:	10.2	↙																													
5:	10.8x	↙																													
6:	10.3	←																													
7:	10.3	↑																													
8:	10.6x	→																													
9:	10.3	↓																													
10:	10.2	↓																													
<table style="width:100%; border-collapse: collapse;"> <tr> <td style="width:80%;"><b>Serie</b></td> <td style="text-align: right;"><b>99.0</b></td> </tr> <tr> <td><b>Total</b></td> <td style="text-align: right;"><b>99.0</b></td> </tr> </table>		<b>Serie</b>	<b>99.0</b>	<b>Total</b>	<b>99.0</b>																										
<b>Serie</b>	<b>99.0</b>																														
<b>Total</b>	<b>99.0</b>																														

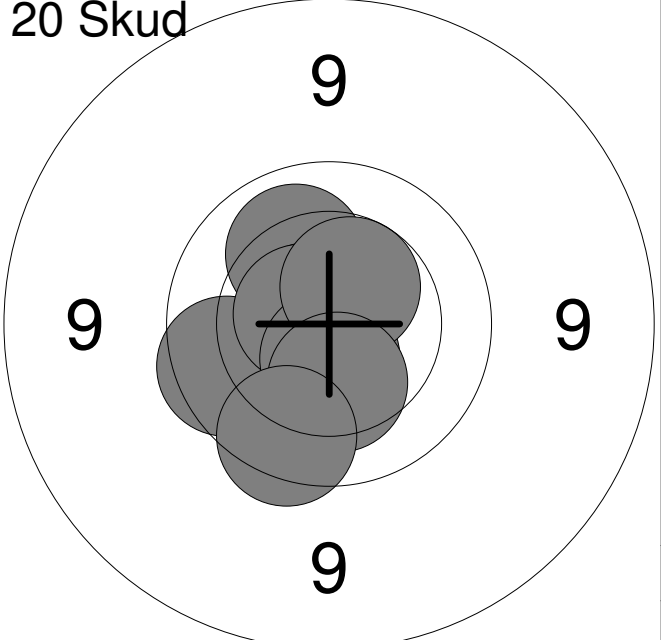
<p><b>20 Skud</b></p> 	<table style="width:100%; border-collapse: collapse;"> <tr><td style="width:10%;">11:</td><td style="width:80%;">10.3</td><td style="width:10%; text-align: right;">↓</td></tr> <tr><td>12:</td><td>10.4</td><td style="text-align: right;">↑</td></tr> <tr><td>13:</td><td>10.1</td><td style="text-align: right;">↑</td></tr> <tr><td>14:</td><td>10.7x</td><td style="text-align: right;">↗</td></tr> <tr><td>15:</td><td>9.8</td><td style="text-align: right;">←</td></tr> <tr><td>16:</td><td>10.7x</td><td style="text-align: right;">↖</td></tr> <tr><td>17:</td><td>10.6x</td><td style="text-align: right;">↓</td></tr> <tr><td>18:</td><td>10.5</td><td style="text-align: right;">↑</td></tr> <tr><td>19:</td><td>10.3</td><td style="text-align: right;">↓</td></tr> <tr><td>20:</td><td>9.8</td><td style="text-align: right;">↙</td></tr> </table>	11:	10.3	↓	12:	10.4	↑	13:	10.1	↑	14:	10.7x	↗	15:	9.8	←	16:	10.7x	↖	17:	10.6x	↓	18:	10.5	↑	19:	10.3	↓	20:	9.8	↙
11:	10.3	↓																													
12:	10.4	↑																													
13:	10.1	↑																													
14:	10.7x	↗																													
15:	9.8	←																													
16:	10.7x	↖																													
17:	10.6x	↓																													
18:	10.5	↑																													
19:	10.3	↓																													
20:	9.8	↙																													
<table style="width:100%; border-collapse: collapse;"> <tr> <td style="width:80%;"><b>Serie</b></td> <td style="text-align: right;"><b>98.0</b></td> </tr> <tr> <td><b>Total</b></td> <td style="text-align: right;"><b>197.0</b></td> </tr> </table>		<b>Serie</b>	<b>98.0</b>	<b>Total</b>	<b>197.0</b>																										
<b>Serie</b>	<b>98.0</b>																														
<b>Total</b>	<b>197.0</b>																														

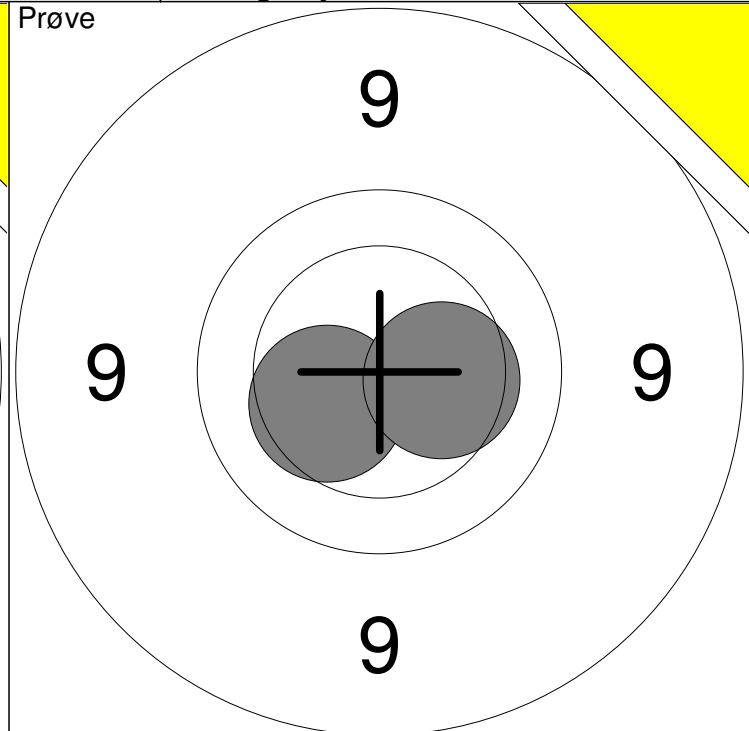
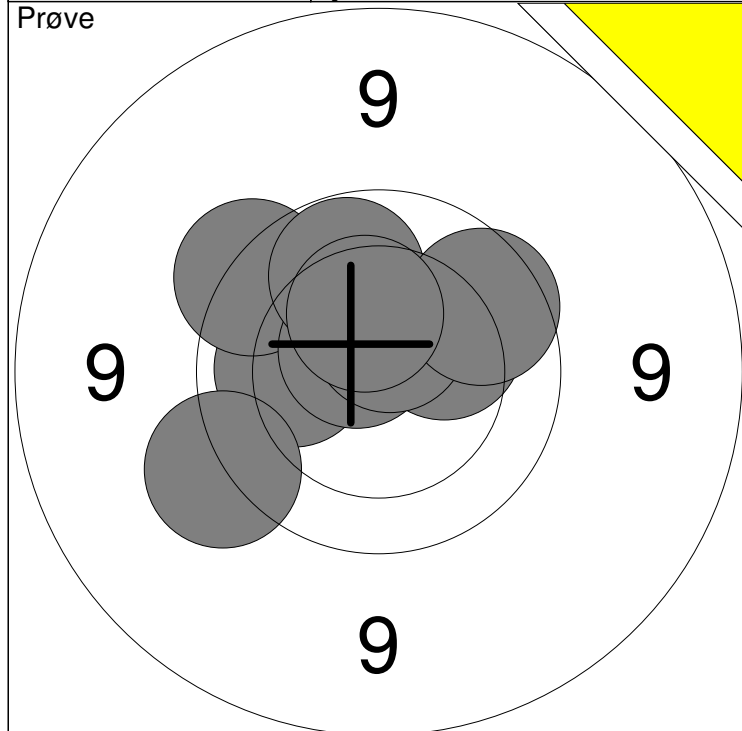

1: 10.0 ↗	6: 10.6x ↗	Serie	97
2: 10.1 ←	7: 9.5 ↙		
3: 9.7 ↗	8: 10.0 ↗	Total	0
4: 10.6x ↗	9: 9.9 ↗		
5: 10.3 ↗	10: 10.4 ↗		

11: 10.4 ↙	Serie	20
12: 10.3 →		
Total		0

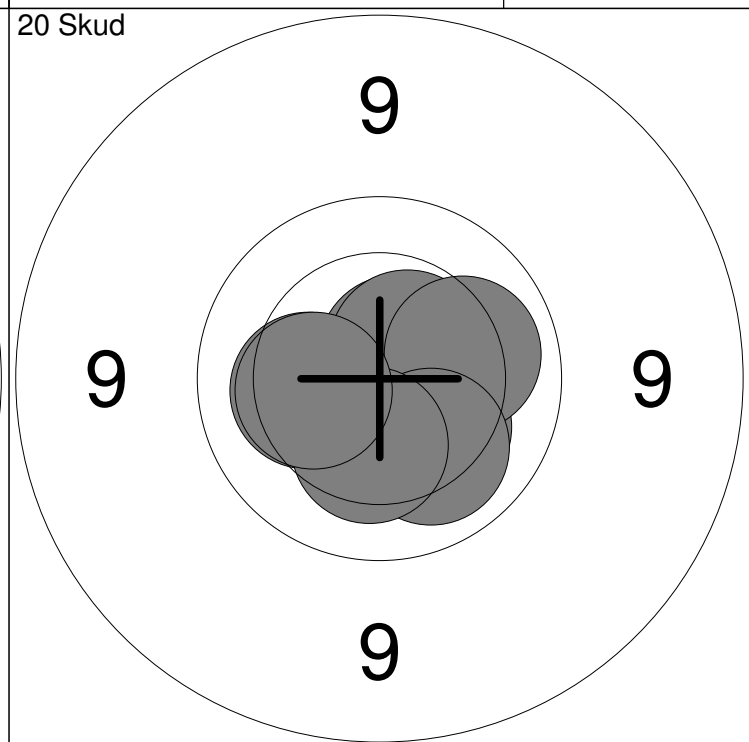
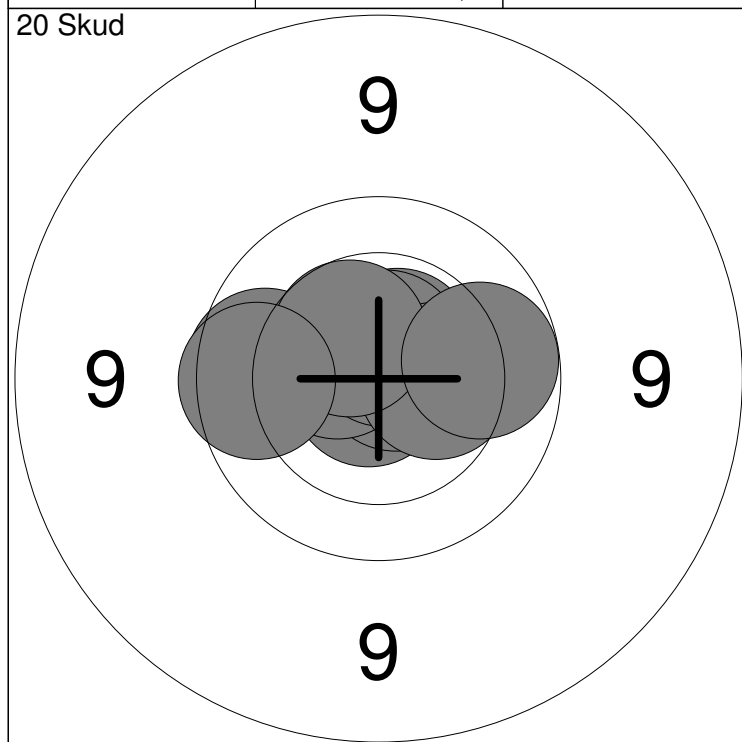

1: 10.8x ↙	6: 10.4 →	Serie	98
2: 10.6x ↗	7: 9.9 ←		
3: 10.8x →	8: 10.5 ↗	Total	98
4: 10.5x ↙	9: 9.8 ←		
5: 10.7x ↗	10: 10.0 →		

11: 10.6x ↙	16: 10.6x ↗	Serie	100
12: 10.3 ←	17: 10.1 →		
13: 10.7x ↘	18: 10.1 ↘	Total	198
14: 10.3 ↘	19: 10.3 ↘		
15: 10.7x ↗	20: 10.3 ←		

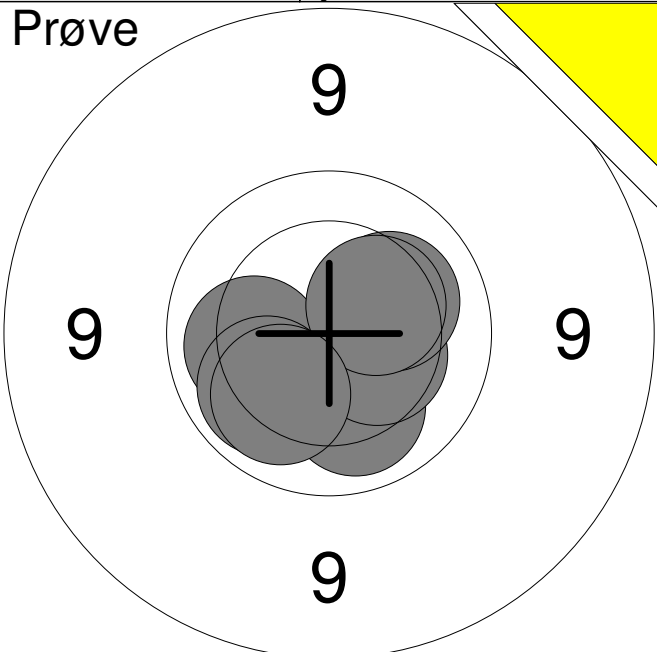
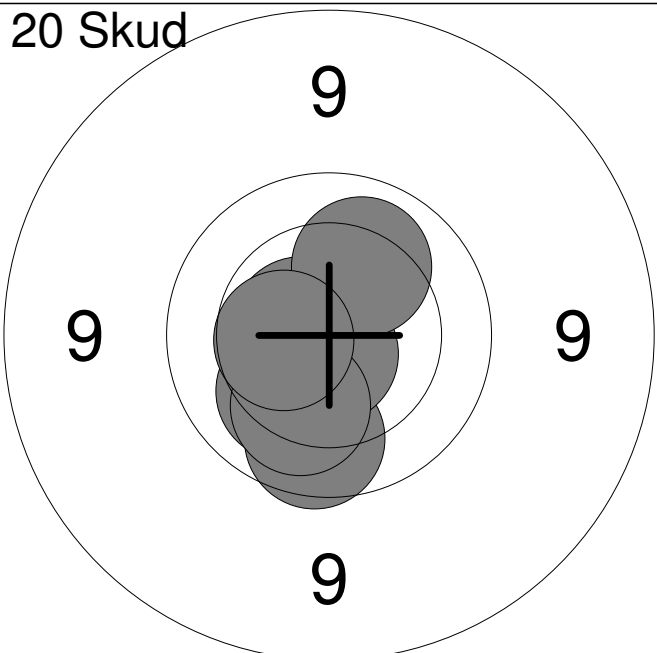
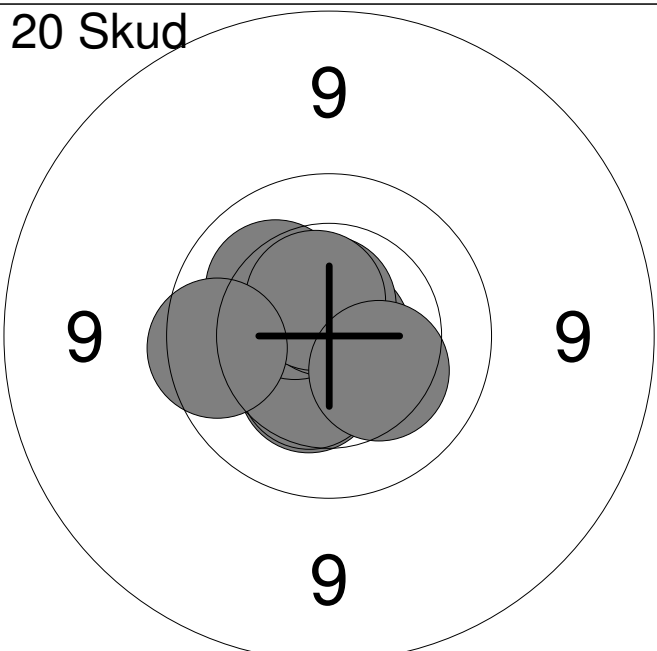
Hold <b>21</b>	Skive <b>9</b>	<b>Frederik B. Sørensen</b>	
15m	Løgstør Sportsskytteklub	MJ1	
11.02.2015	Jyllandsstævne 2015	Aalborg Skyttekreds	
Prøve		1: 10.1 ←	
		2: 10.1 ↓	
		3: 10.4 →	
		4: 10.1 ←	
		5: 10.2 →	
		6: 10.4 →	
		7: 10.1 ↓	
	Serie	70.0	
	Total	0.0	
20 Skud		1: 10.7x ↓	
		2: 10.6x ←	
		3: 10.8x ↓	
		4: 9.9 ↓	
		5: 10.8x ←	
		6: 10.7x ↓	
		7: 10.2 ←	
		8: 10.1 ↓	
		9: 10.1 ↑	
		10: 10.5 ←	
	Serie	99.0	
	Total	99.0	
20 Skud		11: 10.4 ↑	
		12: 10.8x →	
		13: 10.4 ↓	
		14: 10.4 ↓	
		15: 10.5 ↑	
		16: 10.6x ↑	
		17: 10.2 ↑	
		18: 10.5x ↑	
		19: 10.3 ↓	
		20: 9.8 ←	
	Serie	99.0	
	Total	198.0	

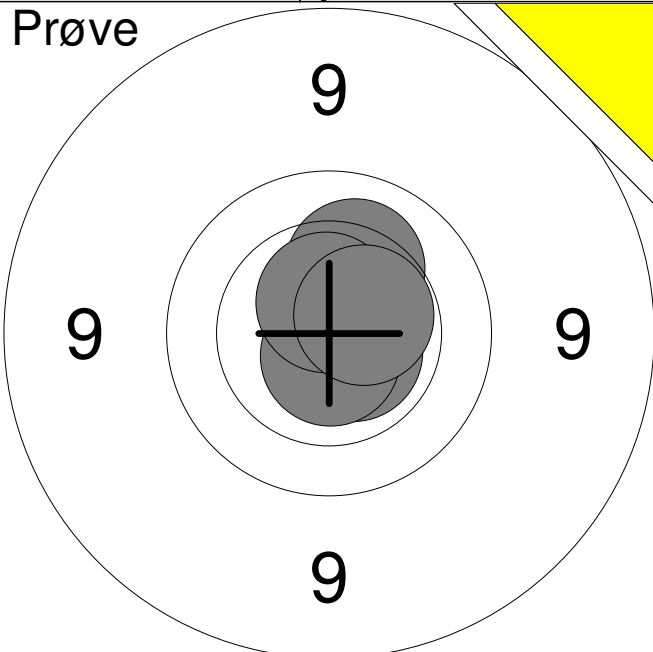
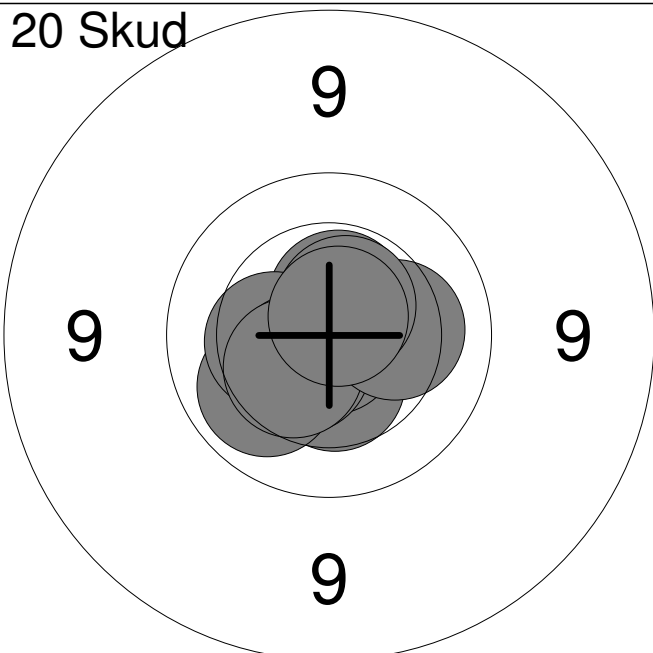
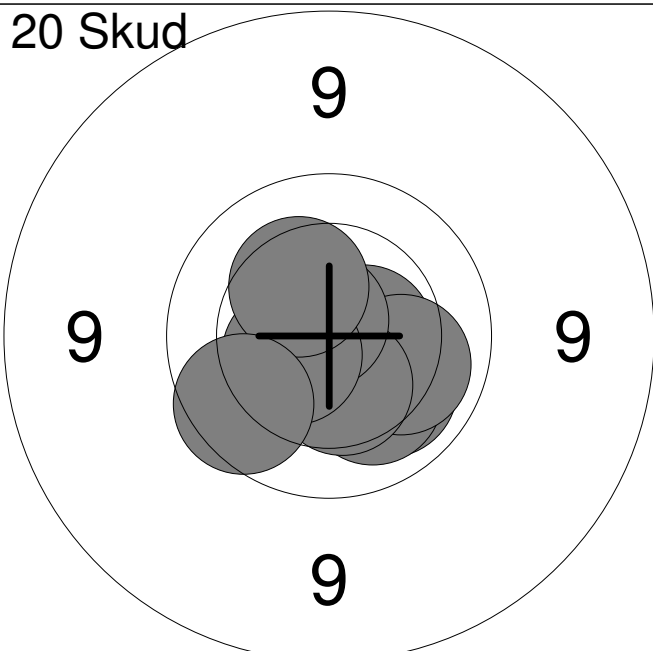
Hold	Skive	Emil L. Nielsen		
21	10	15m	Vester Hassing Skf.	MJ1
11.02.2015	Jyllandsstævne 2015	Aalborg Skyttekreds		
Prøve		1:	10.2	↗
		2:	10.6x	↘
		3:	10.7x	↓
		4:	10.6x	↑
		5:	10.5x	↗
		Serie	50.0	
		Total	0.0	
20 Skud		1:	10.4	↓
		2:	10.1	↙
		3:	10.9x	↓
		4:	10.6x	↑
		5:	10.4	←
		6:	10.5x	↙
		7:	10.4	↙
		8:	10.2	→
		9:	10.6x	↗
		10:	10.7x	↗
		Serie	100.0	
		Total	100.0	
20 Skud		11:	10.1	↘
		12:	10.6x	→
		13:	10.8x	↓
		14:	10.2	↘
		15:	10.1	↘
		16:	10.4	↘
		17:	10.7x	↗
		18:	10.5x	↙
		19:	10.3	↗
		20:	9.8	↙
		Serie	99.0	
		Total	199.0	

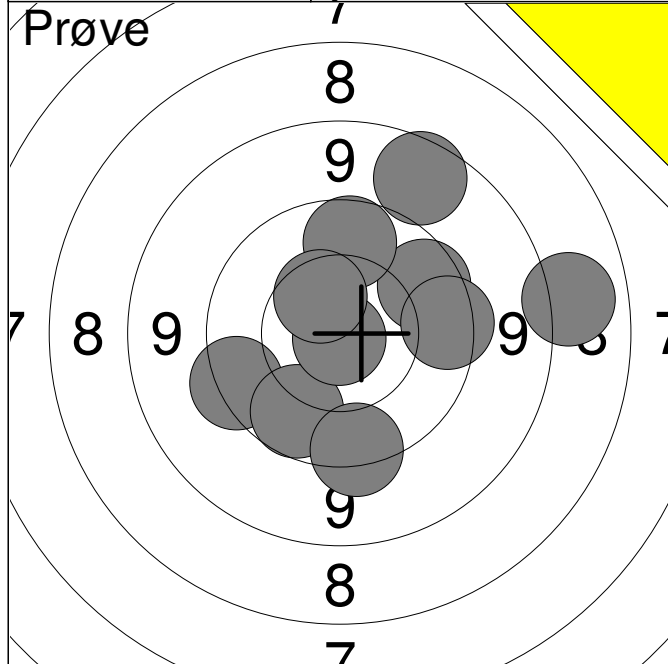

1:	9.6	↙
2:	9.9	↘
3:	8.8	↗
4:	10.9x	↘
5:	9.8	↗
6:	9.7	→
7:	8.1	→
8:	9.9	↑
9:	9.6	↘
10:	10.5	↗
<b>Serie</b>		<b>90.0</b>
<b>Total</b>		<b>0.0</b>

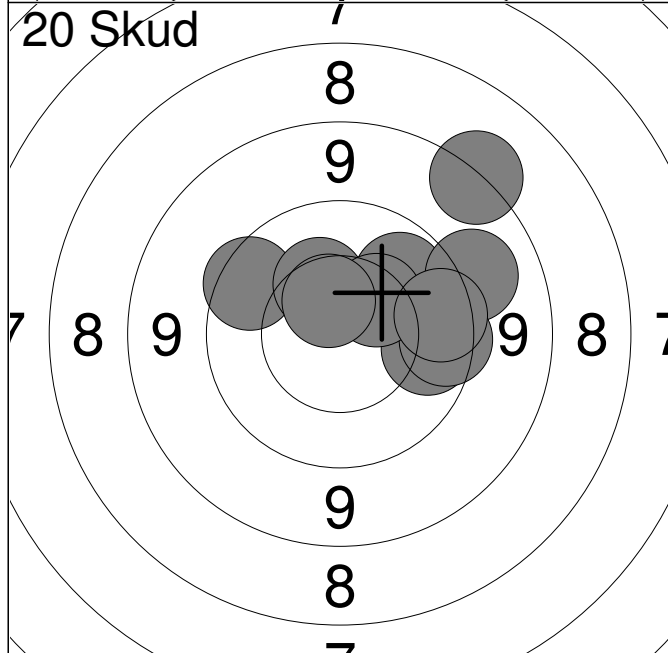

1:	8.4	↗
2:	10.0	↗
3:	9.7	↙
4:	9.2	↗
5:	9.9	→
6:	9.7	→
7:	10.3	↑
8:	10.4	↗
9:	10.5	↑
10:	9.7	→
<b>Serie</b>		<b>93.0</b>
<b>Total</b>		<b>93.0</b>

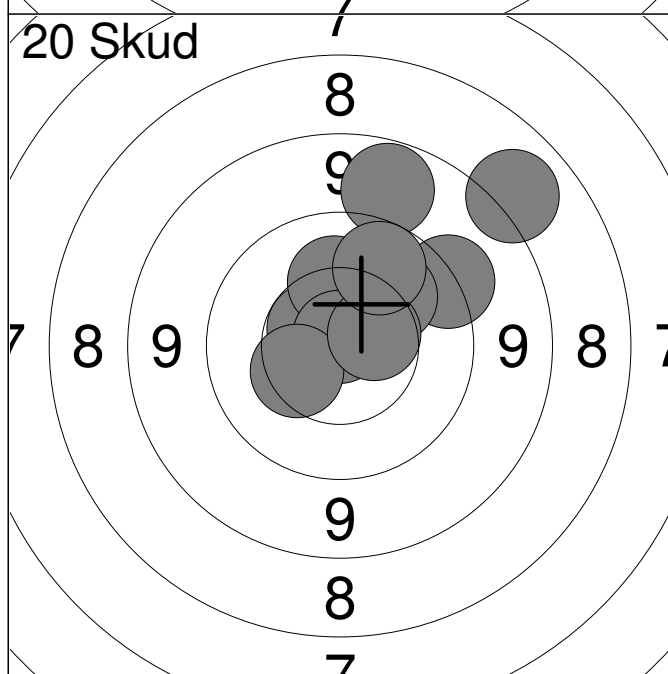

11:	9.4	↗
12:	10.6x	↙
13:	9.0	↑
14:	8.1	↗
15:	10.2	↑
16:	10.8x	↑
17:	10.1	↗
18:	10.4	↙
19:	10.5	→
20:	9.9	↗
<b>Serie</b>		<b>95.0</b>
<b>Total</b>		<b>188.0</b>



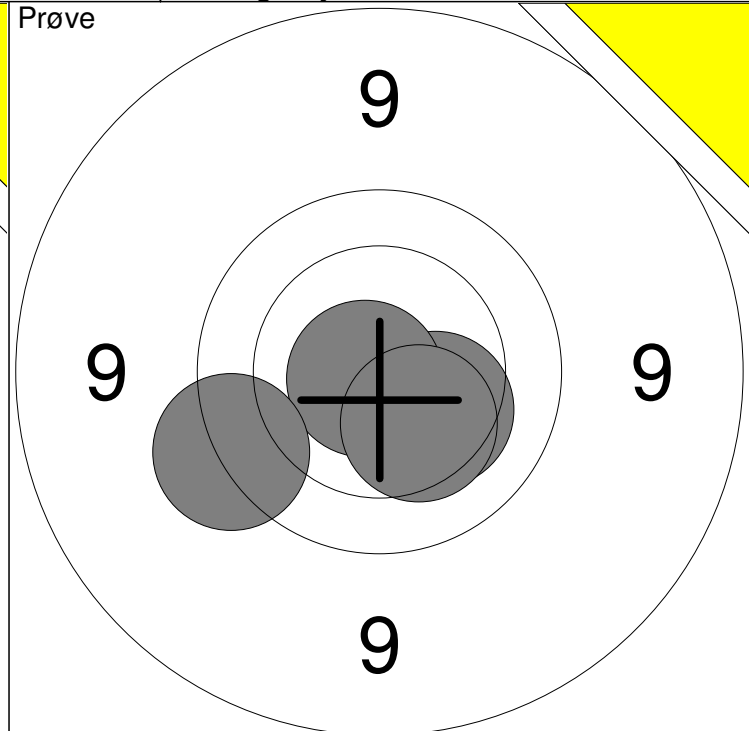
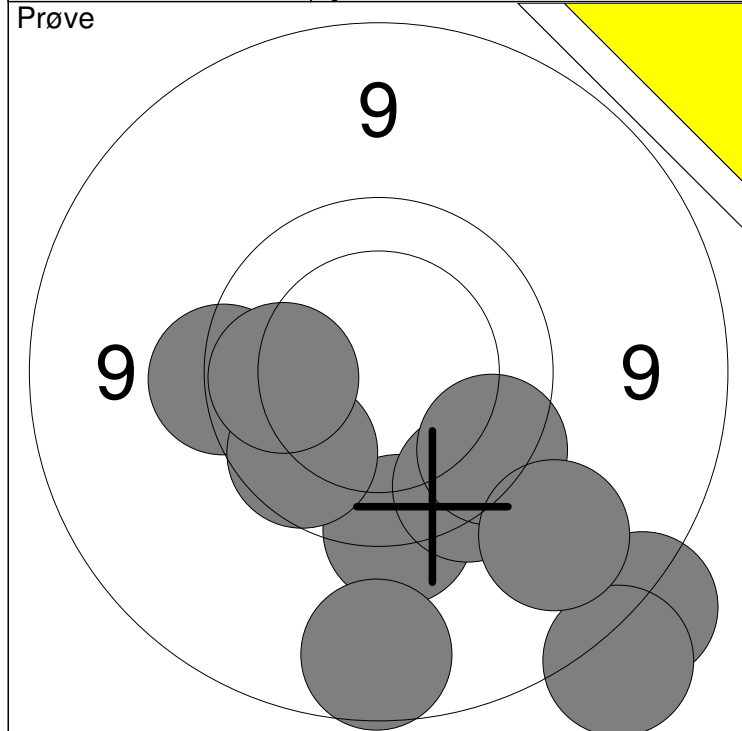

1: 9.6 ↓	6: 9.7 ↘	Serie	88
2: 8.7 ↓	7: 9.1 ↘		
3: 8.6 ↓	8: 9.6 ←	Total	0
4: 8.9 ↓	9: 9.9 ↘		
5: 9.7 ↓	10: 10.0 ←		

11: 10.3 ↘	Serie	39
12: 10.8x ↙		
13: 9.6 ↙	Total	0
14: 10.3 ↓		

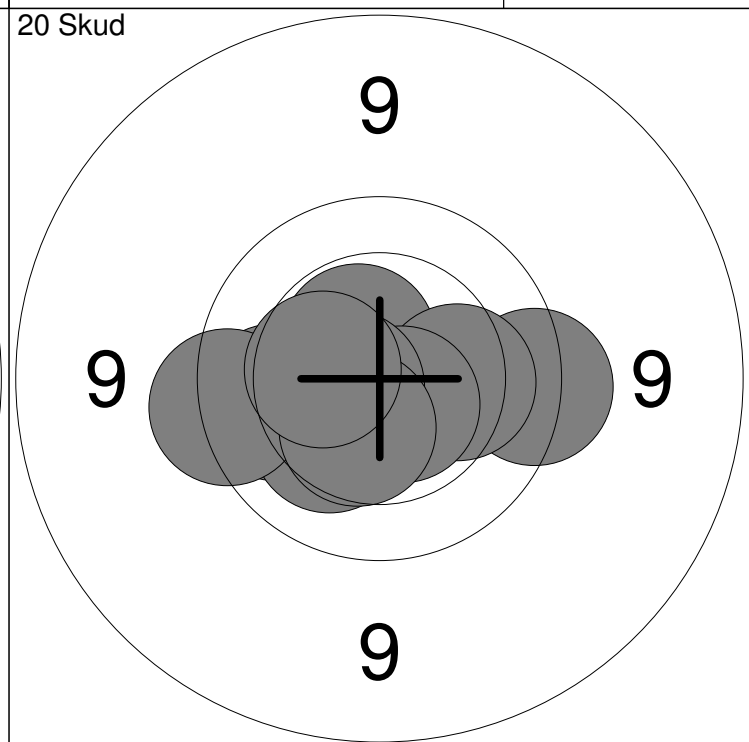
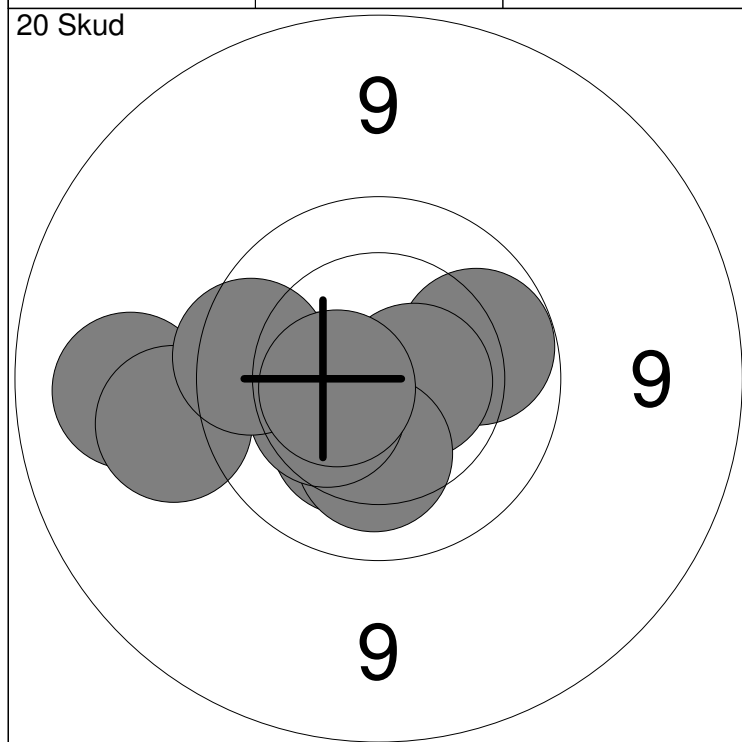

1: 10.3 ↘	6: 10.4 ←	Serie	97
2: 10.0 →	7: 10.4 ↙		
3: 10.6x →	8: 9.4 ←	Total	97
4: 10.2 ↓	9: 9.8 ←		
5: 9.2 ←	10: 10.5x ←		

11: 9.9 ←	16: 10.2 →	Serie	97
12: 10.5x ↗	17: 10.6x ↘		
13: 10.2 ↙	18: 10.6x ←	Total	194
14: 9.7 →	19: 10.4 ↓		
15: 9.7 ←	20: 10.4 ←		

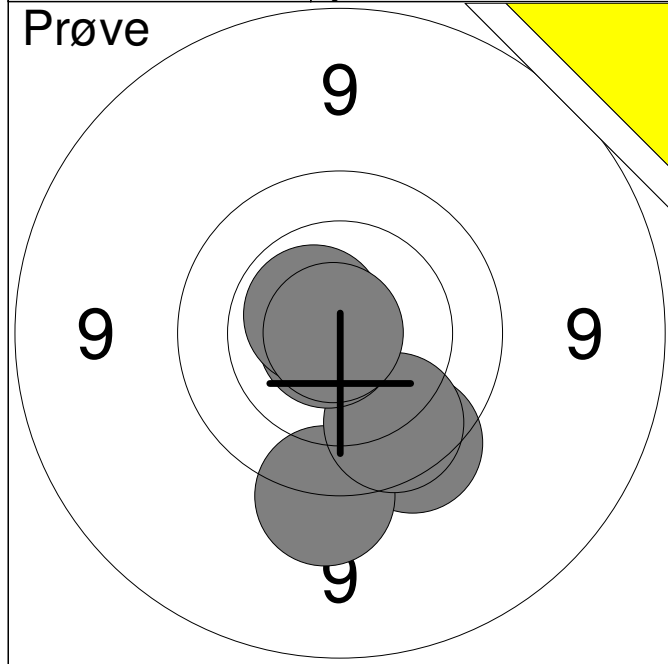

1:	9.7	↘
2:	9.5	↘
3:	9.9	↘
4:	10.8x	↙
5:	10.6x	↗
6:	10.9x	↙
<b>Serie</b>		<b>57.0</b>
<b>Total</b>		<b>0.0</b>

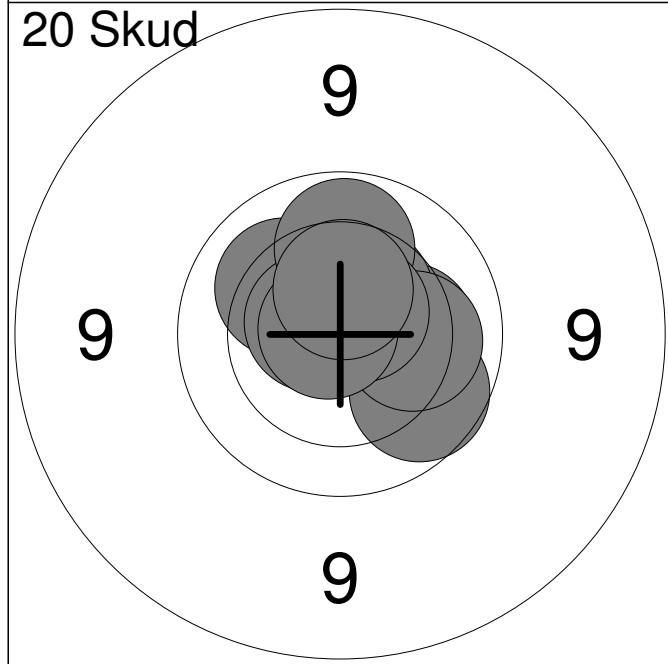

1:	10.2	↗
2:	10.2	→
3:	10.6x	↗
4:	9.9	↘
5:	10.5	↗
6:	10.0	↑
7:	10.2	→
8:	10.6x	↗
9:	10.8x	↙
10:	10.5	↑
<b>Serie</b>		<b>99.0</b>
<b>Total</b>		<b>99.0</b>

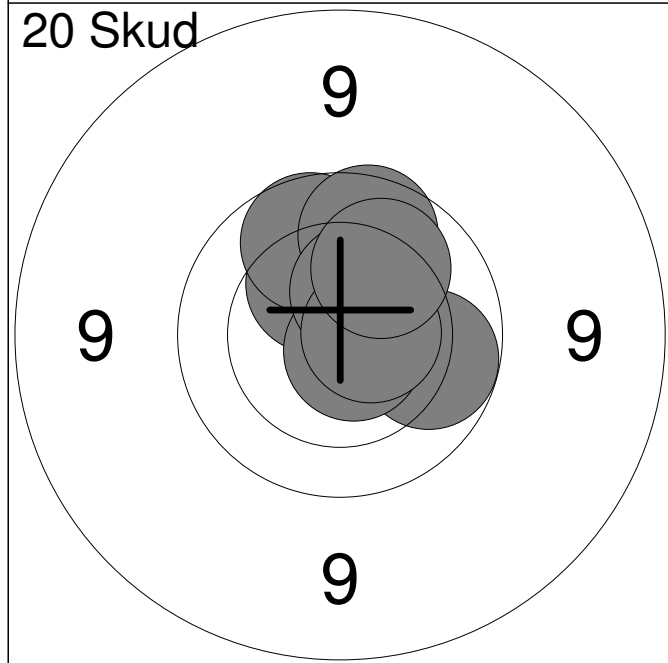

11:	10.6x	↑
12:	10.3	↗
13:	10.5x	↗
14:	9.9	↑
15:	10.0	→
16:	9.9	↑
17:	10.7x	↘
18:	10.4	↗
19:	10.6x	→
20:	10.1	↗
<b>Serie</b>		<b>98.0</b>
<b>Total</b>		<b>197.0</b>

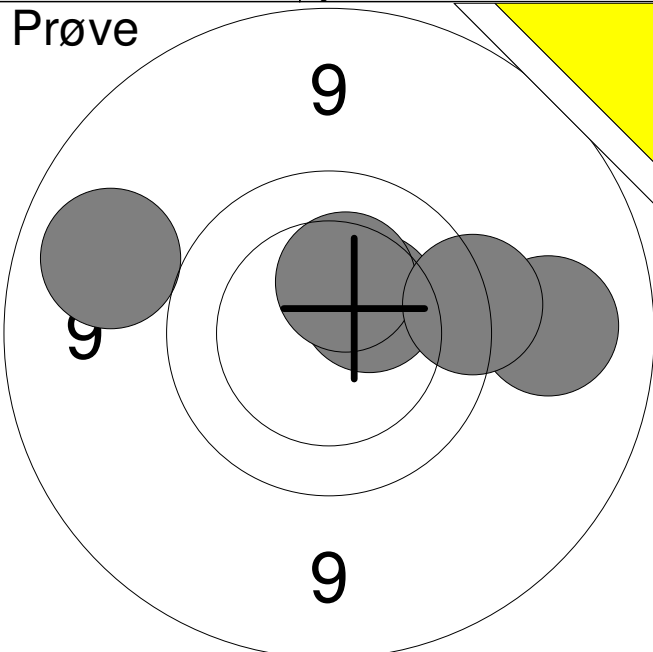
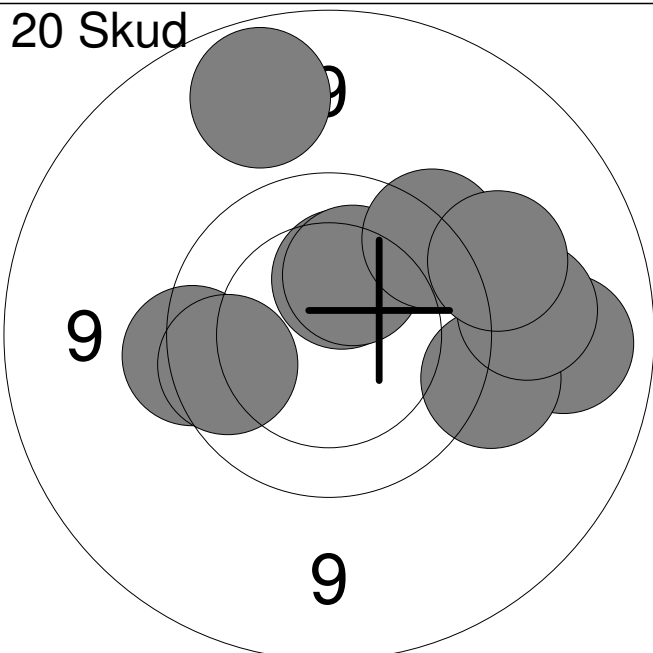
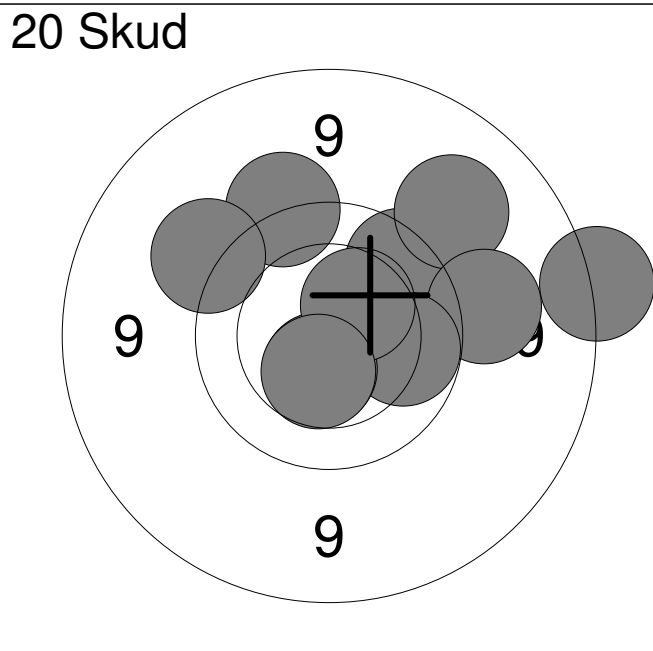
Hold <b>22</b>	Skive <b>2</b>	<b>Morten Larsen</b>		
15m	Vester Hassing Skf.	M2		
11.02.2015	Jyllandsstævne 2015	Aalborg Skyttekreds		
Prøve 	1:	9.2	→	
	2:	10.4	↗	
	3:	10.4	↑	
	4:	9.6	→	
	6:	9.1	←	
	Serie			47.0
	Total			0.0
20 Skud 	1:	9.7	←	
	2:	9.9	←	
	3:	9.1	→	
	4:	10.3	↑	
	5:	9.0	↑	
	6:	9.5	→	
	7:	10.3	↑	
	8:	9.3	→	
	9:	9.7	↗	
	10:	9.4	→	
	Serie			92.0
	Total			92.0
20 Skud 	11:	8.6	→	
	12:	9.8	↗	
	13:	9.5	↑	
	14:	9.2	↗	
	15:	9.4	↖	
	16:	9.3	→	
	17:	10.0	→	
	18:	10.5x	↓	
	19:	10.4	↗	
	20:	10.5	↓	
	Serie			93.0
	Total			185.0

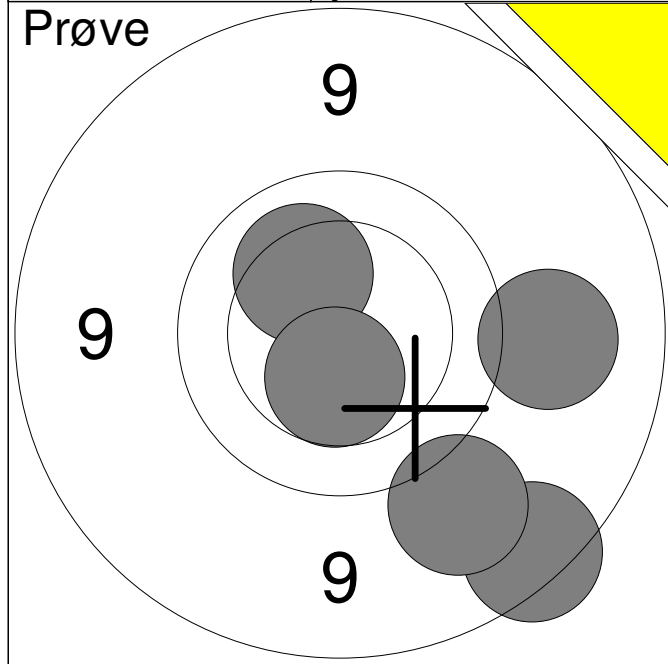

1:	10.2	↗
2:	8.8	↘
3:	9.2	→
4:	9.2	↘
5:	10.5	↘
<b>Serie</b>		<b>46.0</b>
<b>Total</b>		<b>0.0</b>

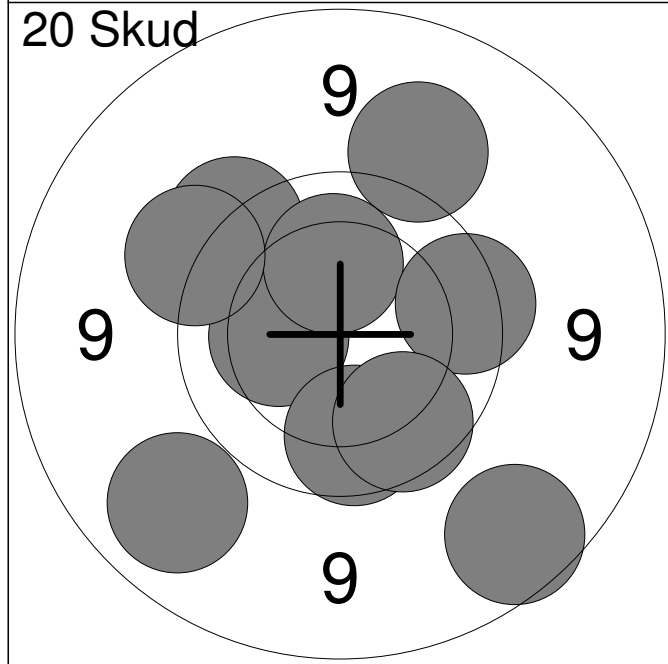

1:	9.1	↙
2:	8.9	↘
3:	9.6	↗
4:	9.3	↗
5:	10.3	←
6:	10.2	↑
7:	9.5	↗
8:	9.7	→
9:	9.9	↘
10:	9.9	↘
<b>Serie</b>		<b>91.0</b>
<b>Total</b>		<b>91.0</b>

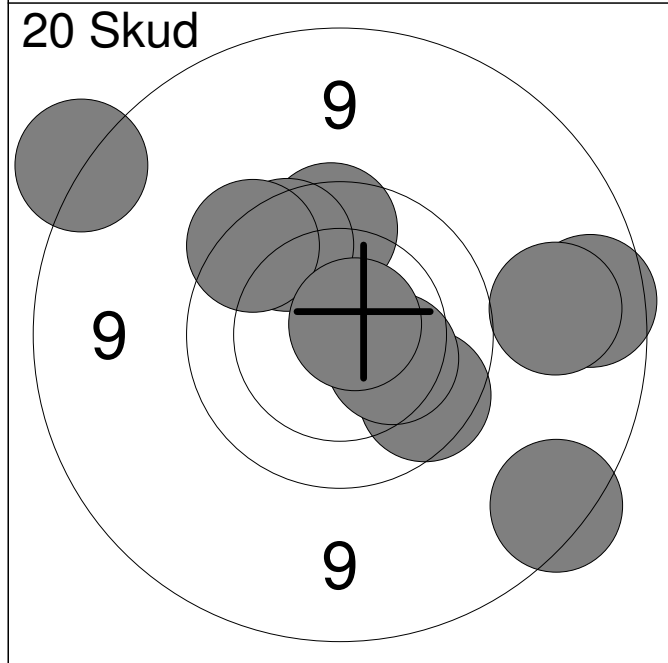

11:	9.8	↘
12:	8.8	↘
13:	8.7	↗
14:	9.8	↑
15:	10.3	↘
16:	8.9	→
17:	9.8	↗
18:	9.7	↗
19:	9.1	→
20:	10.7x	↗
<b>Serie</b>		<b>89.0</b>
<b>Total</b>		<b>180.0</b>

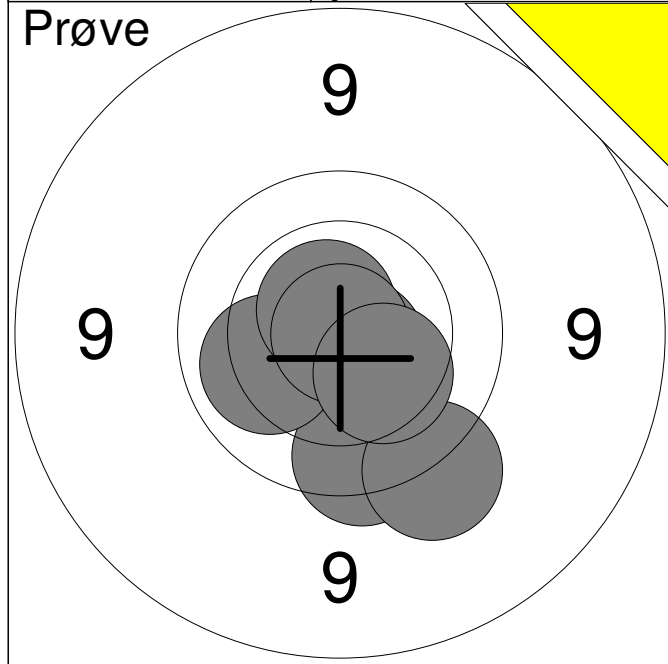

1:	10.7x	↘
2:	9.8	↘
3:	9.5	↘
4:	10.1	↖
5:	10.7x	↗
6:	10.9x	↘
7:	10.3	↘
<b>Serie</b>		<b>68.0</b>
<b>Total</b>		<b>0.0</b>

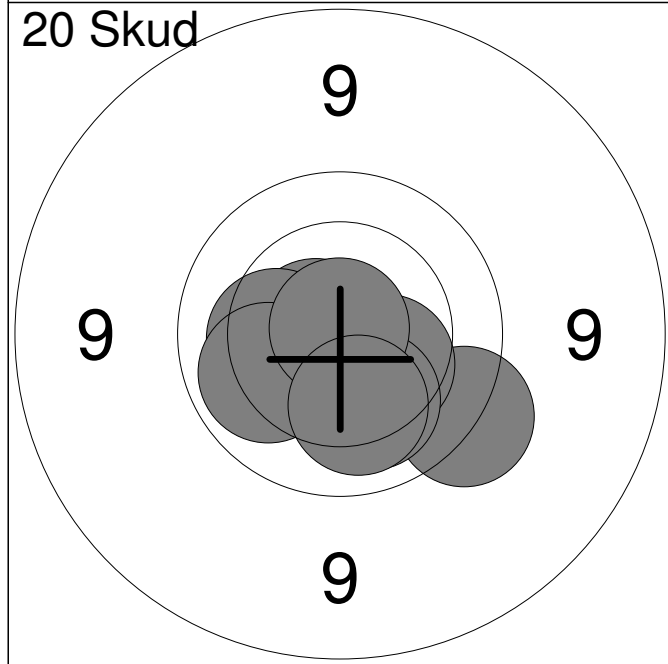

1:	10.5	↘
2:	10.4	↘
3:	9.6	↘
4:	10.7x	↖
5:	10.4	↘
6:	10.3	↖
7:	10.1	↖
8:	10.2	↘
9:	10.9x	↗
10:	10.2	↘
<b>Serie</b>		<b>99.0</b>
<b>Total</b>		<b>99.0</b>

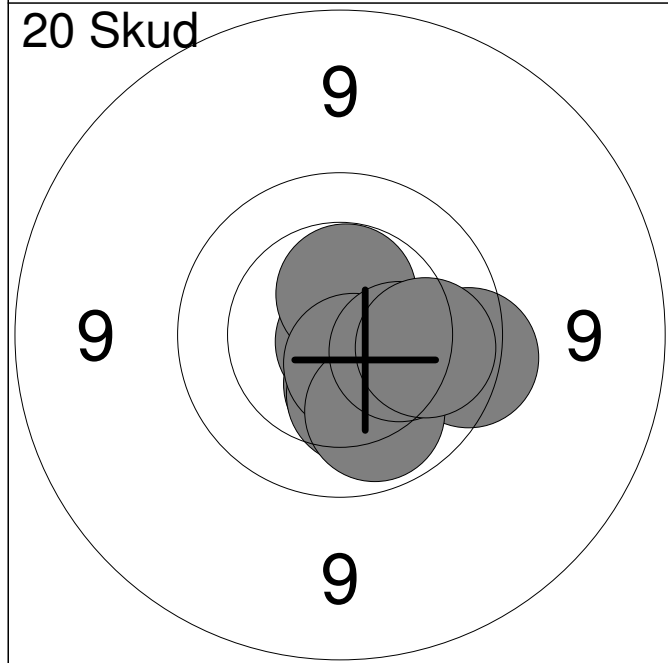

11:	9.7	→
12:	10.4	↘
13:	10.9x	↘
14:	10.4	↘
15:	10.5x	↗
16:	10.3	↘
17:	10.6x	↘
18:	10.0	↘
19:	10.3	→
20:	10.0	→
<b>Serie</b>		<b>99.0</b>
<b>Total</b>		<b>198.0</b>

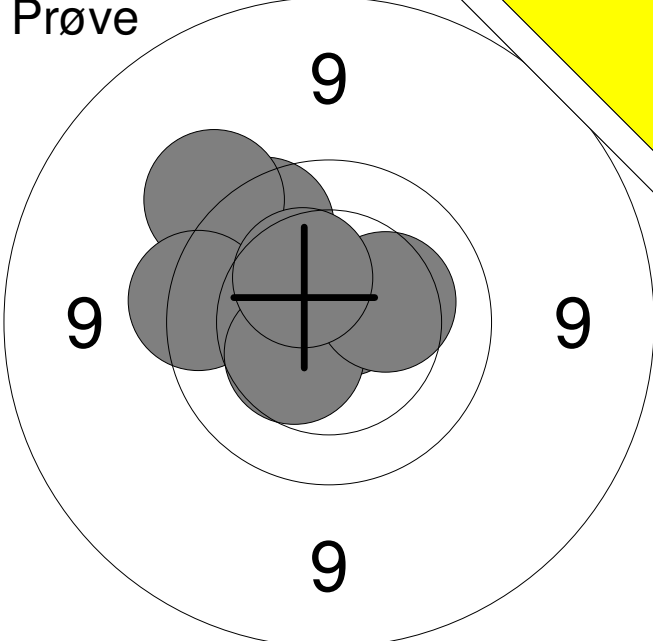
<b>Prøve</b> 	1:	10.7x	↗
	2:	10.1	↗
	3:	9.8	↗
	4:	9.5	↗
	5:	9.7	↖
	6:	10.4	↙
	7:	10.3	→
	8:	10.4	↗
	<b>Serie</b>		<b>77.0</b>
<b>Total</b>		<b>0.0</b>	

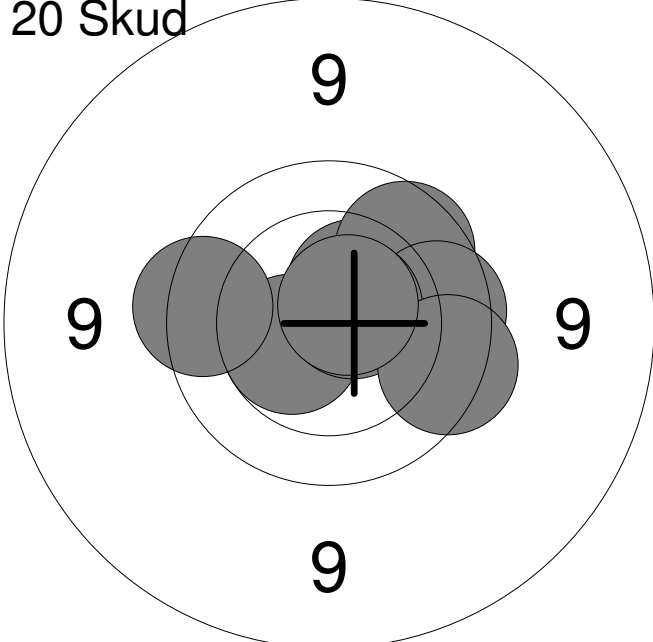
<b>20 Skud</b> 	1:	10.6x	↗
	2:	10.6x	↗
	3:	10.5	↙
	4:	10.5	↗
	5:	9.9	↗
	6:	9.9	→
	7:	10.7x	↗
	8:	9.7	→
	9:	10.7x	↗
	10:	9.7	↖
<b>Serie</b>		<b>96.0</b>	
<b>Total</b>		<b>96.0</b>	

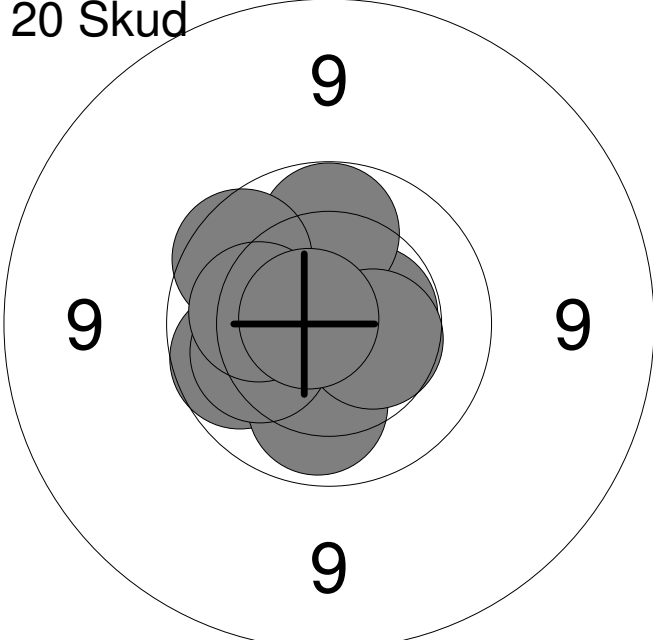
<b>20 Skud</b> 	11:	9.9	↖
	12:	10.5	↓
	13:	10.5x	→
	14:	10.1	↓
	15:	10.1	↖
	16:	10.0	↑
	17:	9.9	↗
	18:	10.2	↖
	19:	10.5	→
	20:	10.7x	↖
	<b>Serie</b>		<b>98.0</b>
<b>Total</b>		<b>194.0</b>	

Hold <b>22</b>	Skive <b>6</b>	<b>Lars Jakobsen</b>	
-------------------	-------------------	----------------------	--

15m	Vilsted Skf.	ÅK1
-----	--------------	-----

11.02.2015	Jyllandsstævne 2015	Aalborg Skyttekreds
------------	---------------------	---------------------

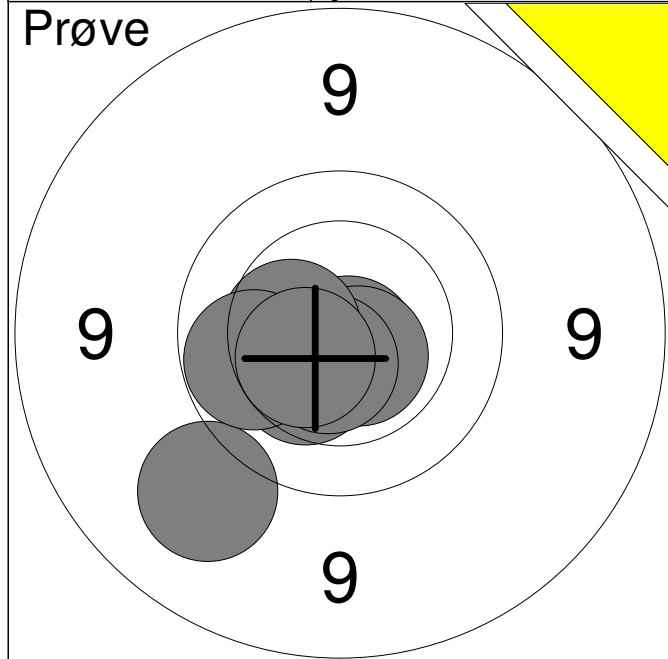

1:	9.3	↙
2:	10.8x	↘
3:	10.6x	↘
4:	10.4	↙
5:	10.6x	↘
6:	10.4	←
7:	10.0	←
8:	10.5x	↙
<b>Serie</b>		<b>79.0</b>
<b>Total</b>		<b>0.0</b>

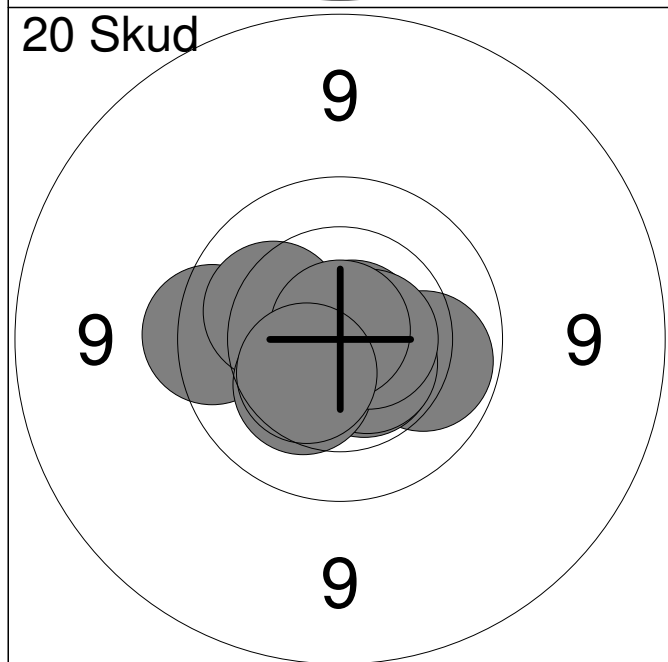

1:	10.0	→
2:	10.6x	↘
3:	10.8x	↗
4:	9.7	←
5:	10.2	↗
6:	10.6x	↘
7:	10.3	↙
8:	10.7x	→
9:	10.9x	↑
10:	10.4	↙
<b>Serie</b>		<b>99.0</b>
<b>Total</b>		<b>99.0</b>

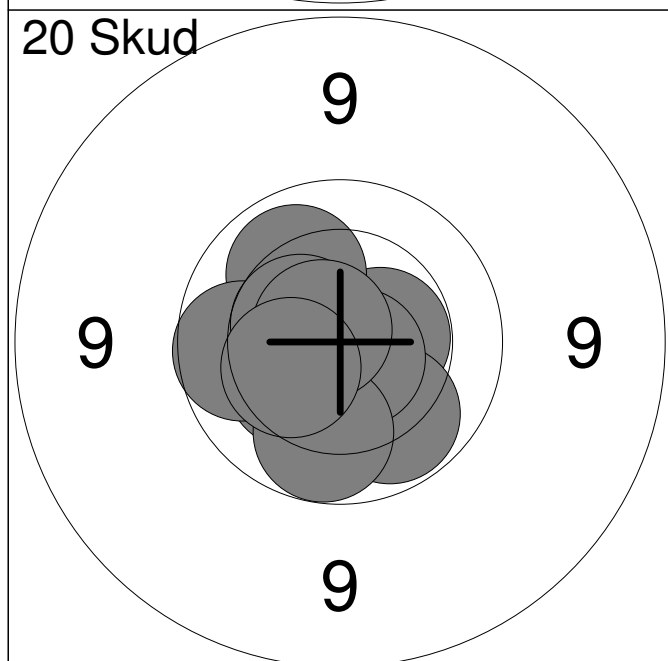

11:	10.5x	→
12:	10.3	↙
13:	10.0	↘
14:	10.1	↗
15:	10.7x	↘
16:	9.9	←
17:	10.5	↗
18:	10.0	↘
19:	10.7x	↗
20:	10.4	↙
<b>Serie</b>		<b>99.0</b>
<b>Total</b>		<b>198.0</b>

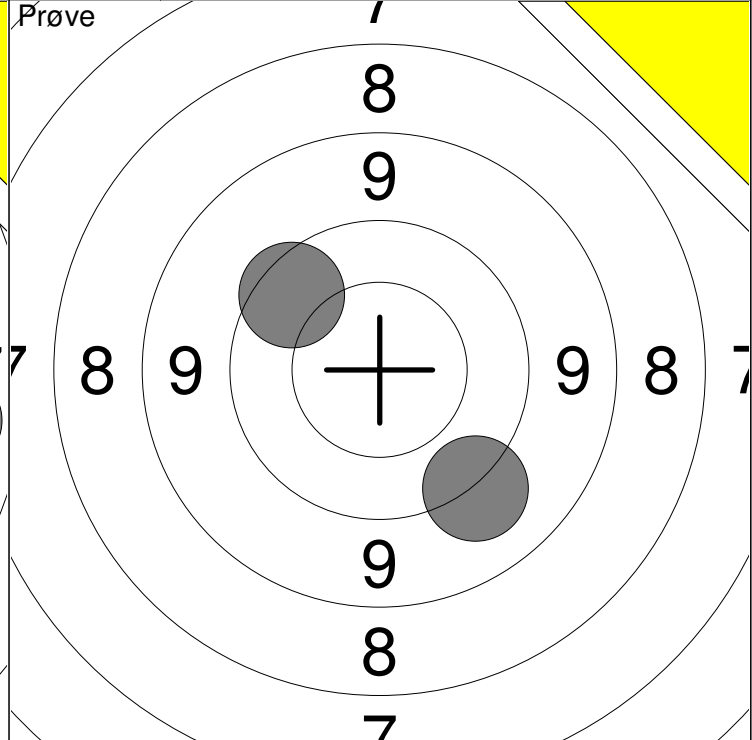
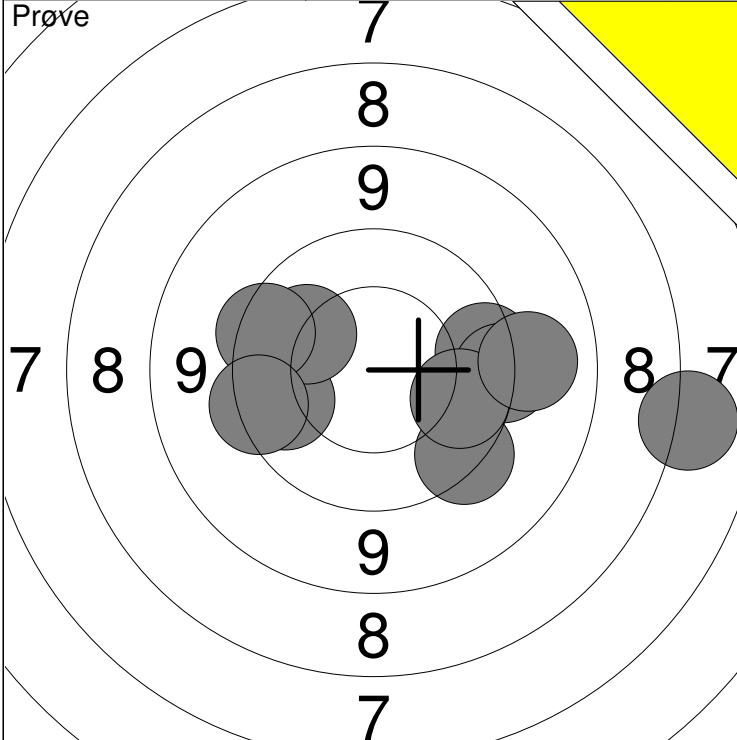

1: 9.9 ←	6: 9.5 →	Serie	90
2: 10.1 ↗	7: 9.5 ↘		
3: 9.7 →	8: 7.2 →	Total	0
4: 9.7 ↖	9: 10.0 ↘		
5: 9.6 ←	10: 9.2 →		

11: 9.3 ↘	Serie	18
12: 9.7 ↗		
Total		0

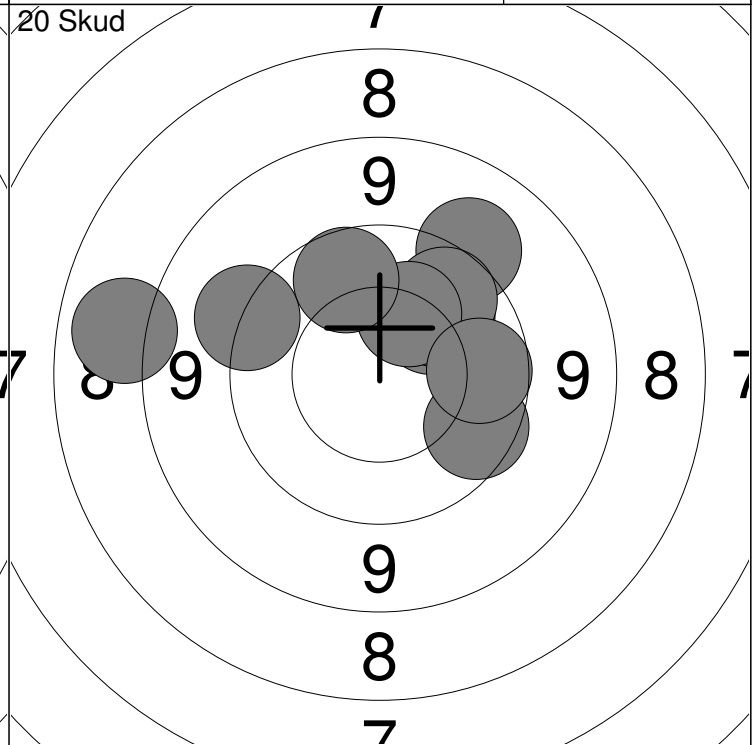
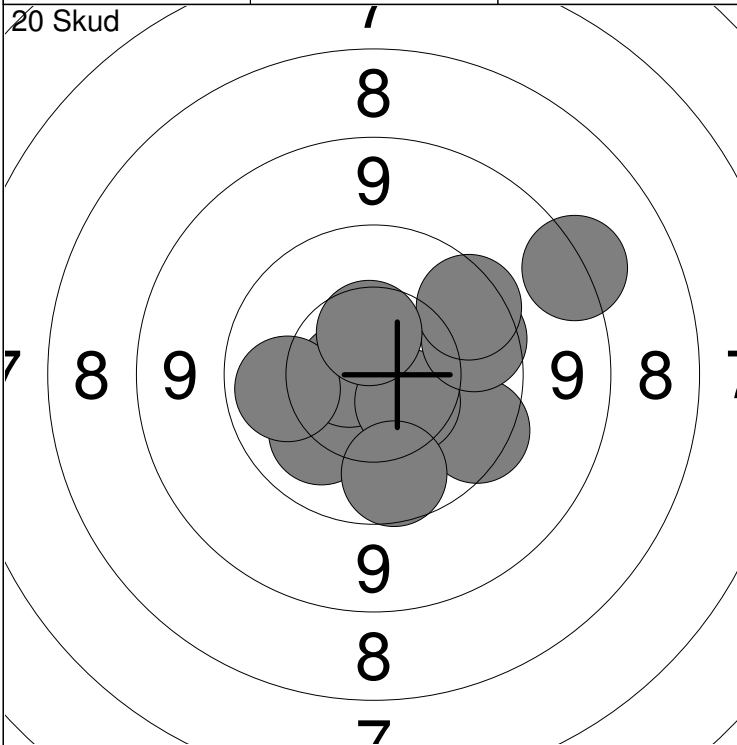

1: 10.1 ↘	6: 9.8 →	Serie	94
2: 9.7 ↘	7: 9.9 ↓		
3: 8.5 ↗	8: 10.0 ←	Total	94
4: 10.7x ←	9: 9.7 ↗		
5: 10.5 ↘	10: 10.5 ↑		

11: 10.2 ↗	16: 10.3 ↗	Serie	92
12: 9.3 ↗	17: 8.1 ←		
13: 10.1 ↗	18: 9.8 ↘	Total	186
14: 9.4 ↖	19: 9.9 →		
15: 9.9 ↗	20: 9.9 ↑		



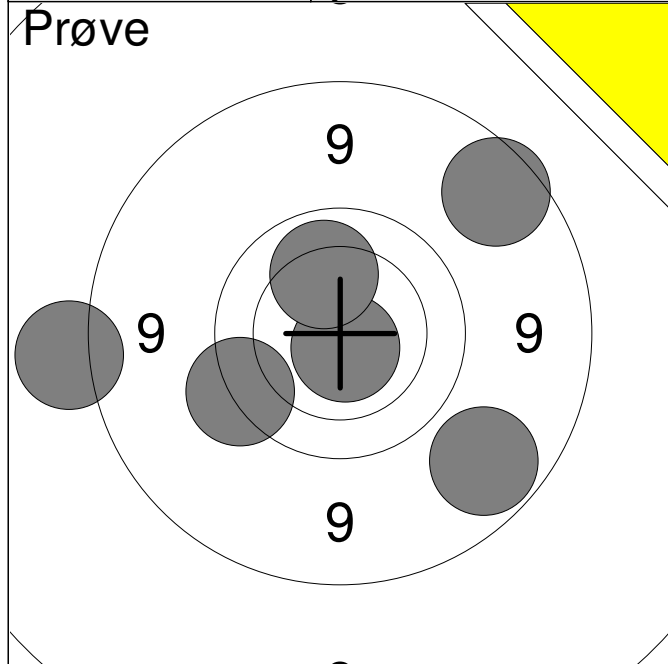

1:	8.9	↗
2:	8.6	←
3:	9.0	↘
4:	9.6	↙
5:	10.7x	↘
6:	10.1	↗
<b>Serie</b>		<b>54.0</b>
<b>Total</b>		<b>0.0</b>

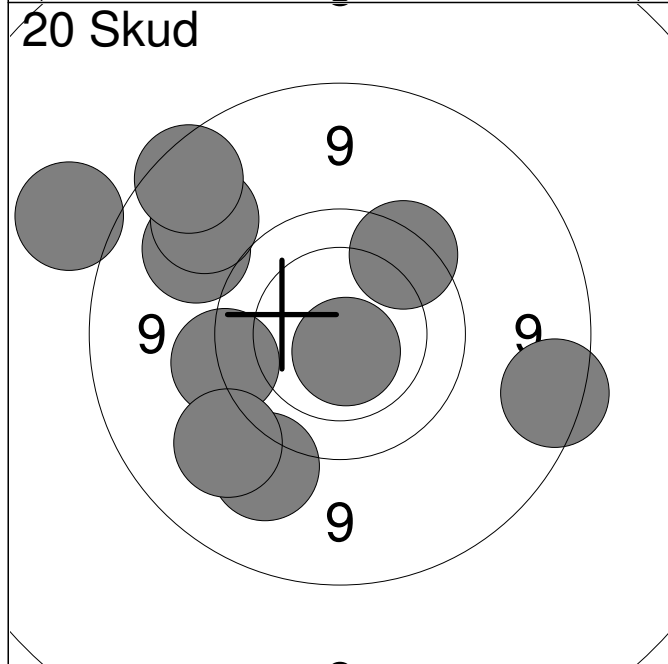

1:	9.3	↘
2:	9.6	←
3:	9.2	↗
4:	9.1	↗
5:	8.8	→
6:	9.3	↘
7:	8.8	↗
8:	8.4	↗
9:	9.7	↗
10:	10.7x	↘
<b>Serie</b>		<b>88.0</b>
<b>Total</b>		<b>88.0</b>

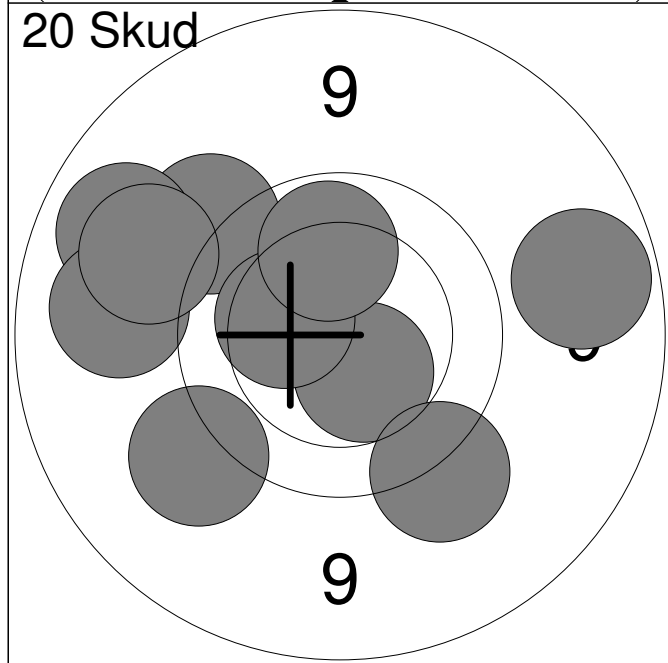

11:	10.5	↘
12:	9.5	↘
13:	9.5	↗
14:	10.3	↗
15:	10.0	↗
16:	9.1	↗
17:	9.2	←
18:	9.4	↘
19:	9.0	→
20:	9.2	←
<b>Serie</b>		<b>93.0</b>
<b>Total</b>		<b>181.0</b>

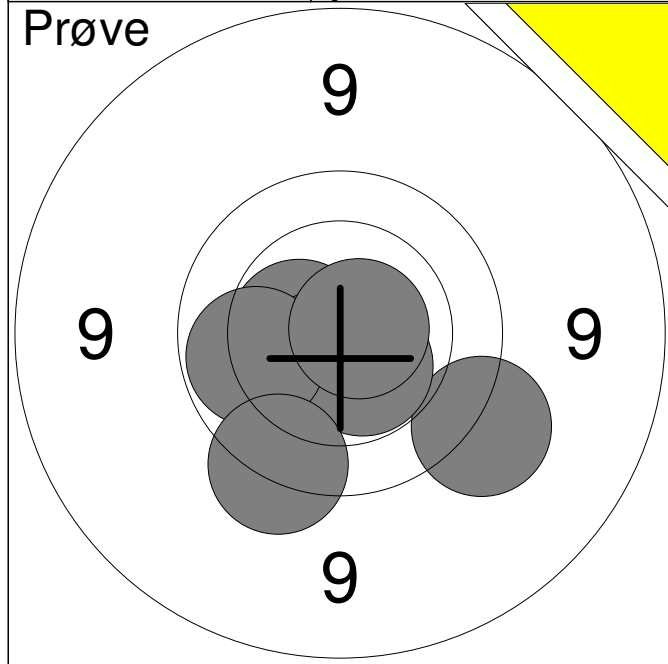

1:	9.5	↘
2:	10.5x	←
3:	10.6x	↙
4:	10.5x	↘
5:	10.0	←
6:	9.6	↙
7:	10.7x	→
<b>Serie</b>		<b>68.0</b>
<b>Total</b>		<b>0.0</b>

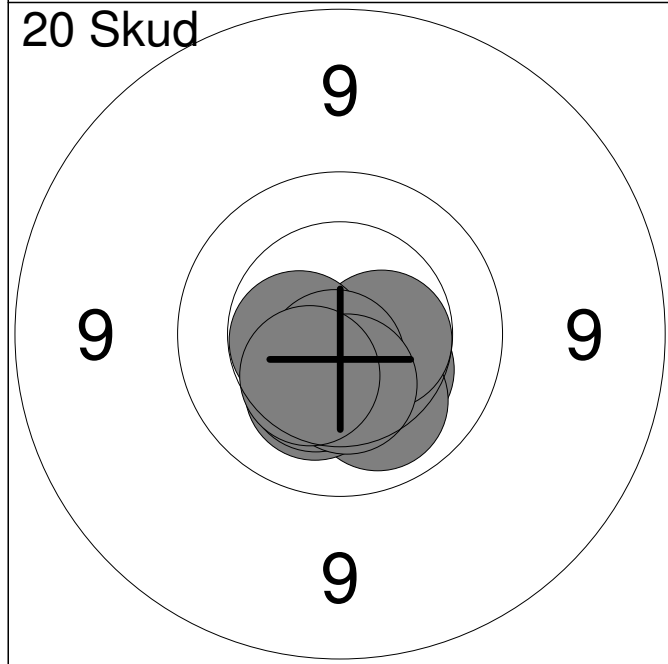

1:	10.3	↘
2:	10.1	↘
3:	10.6x	↙
4:	10.3	↘
5:	10.5x	→
6:	10.5x	←
7:	10.4	↙
8:	10.7x	↘
9:	10.4	↘
10:	10.4	↙
<b>Serie</b>		<b>100.0</b>
<b>Total</b>		<b>100.0</b>

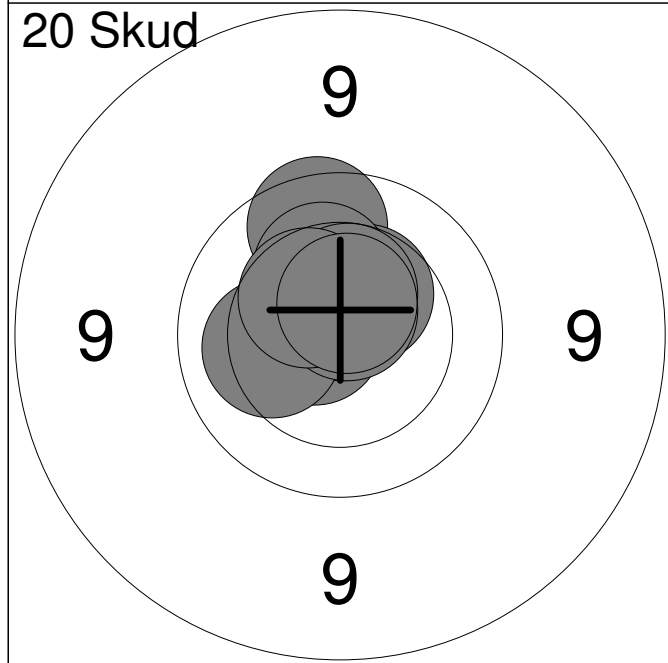

11:	10.7x	←
12:	10.7x	↑
13:	9.8	↑
14:	10.4	↗
15:	10.2	←
16:	10.2	↑
17:	10.5x	↑
18:	10.7x	↑
19:	10.4	↖
20:	10.6x	↑
<b>Serie</b>		<b>99.0</b>
<b>Total</b>		<b>199.0</b>

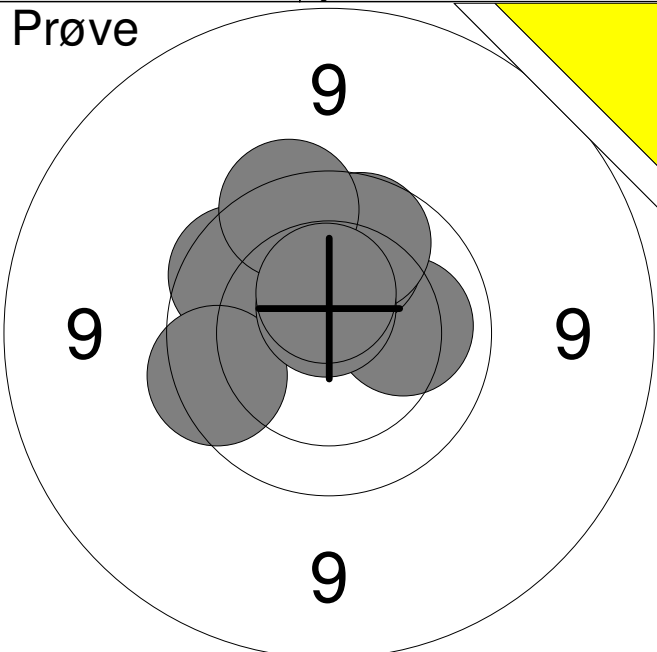
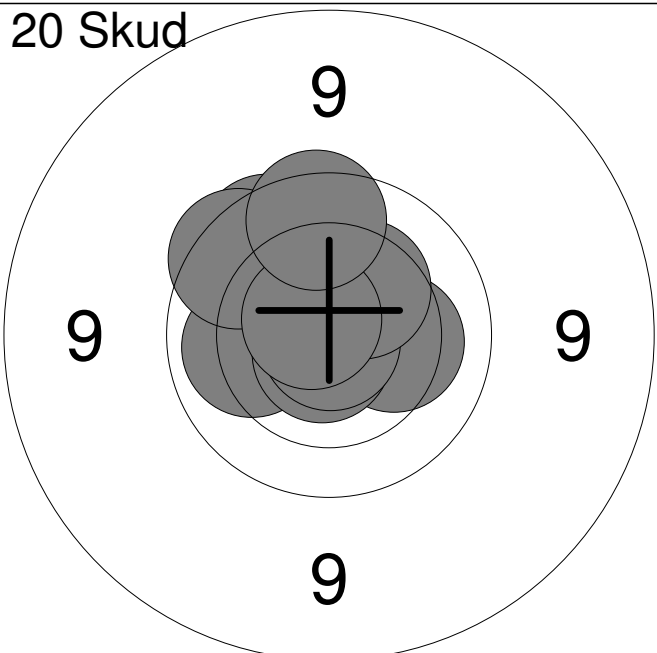
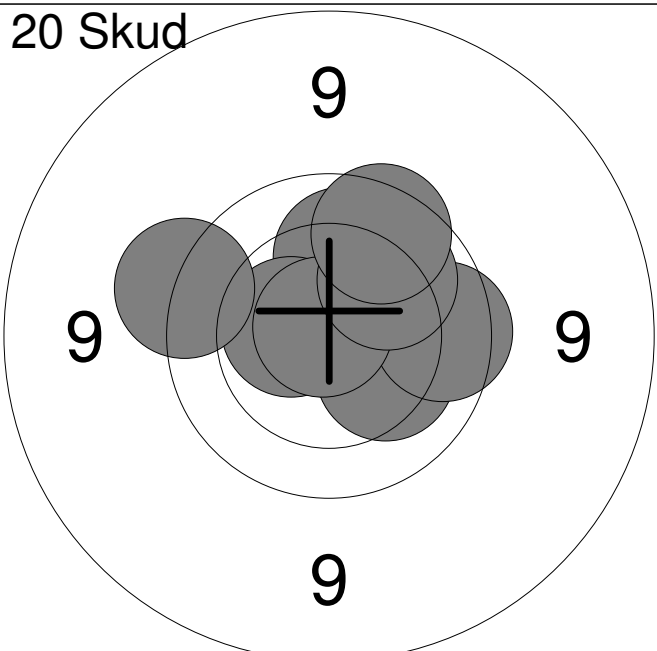
Hold	Skive	Jens Nielsen	
22	10	15m	Vester Hassing Skf. MÅ2
11.02.2015	Jyllandsstævne 2015	Aalborg Skyttekreds	
Prøve		1: 10.1 →	
		2: 9.9 ↖	
		3: 10.1 ↑	
		4: 9.9 ↑	
		5: 9.7 ↑	
		6: 9.8 ↖	
		7: 10.7x ↑	
		8: 10.5x ↑	
		<b>Serie</b>	<b>76.0</b>
		<b>Total</b>	<b>0.0</b>
20 Skud		1: 9.8 ↖	
		2: 10.2 →	
		3: 10.1 ↖	
		4: 10.7x ↓	
		5: 10.5x ↑	
		6: 10.9x ↓	
		7: 10.3 ↗	
		8: 9.8 ↖	
		9: 10.7x ↗	
		10: 9.8 ↑	
		<b>Serie</b>	<b>97.0</b>
		<b>Total</b>	<b>97.0</b>
20 Skud		11: 10.8x ↗	
		12: 10.1 →	
		13: 10.1 ↑	
		14: 10.2 ↘	
		15: 10.5x ↖	
		16: 9.8 →	
		17: 10.8x ↗	
		18: 9.6 ↖	
		19: 10.1 ↗	
		20: 9.8 ↑	
		<b>Serie</b>	<b>97.0</b>
		<b>Total</b>	<b>194.0</b>

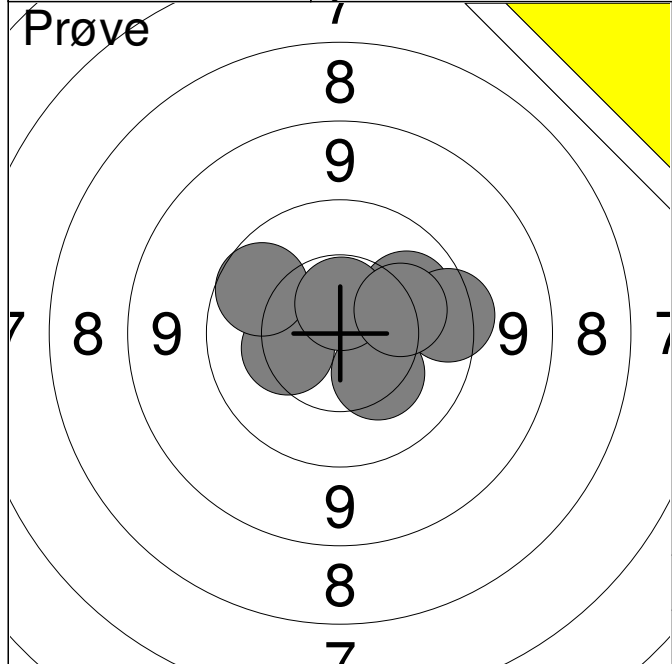

1:	10.3	←
2:	9.9	↖
3:	10.1	→
4:	9.7	→
5:	10.3	↘
6:	10.6x	↑
7:	10.2	→
<b>Serie</b>		<b>68.0</b>
<b>Total</b>		<b>0.0</b>

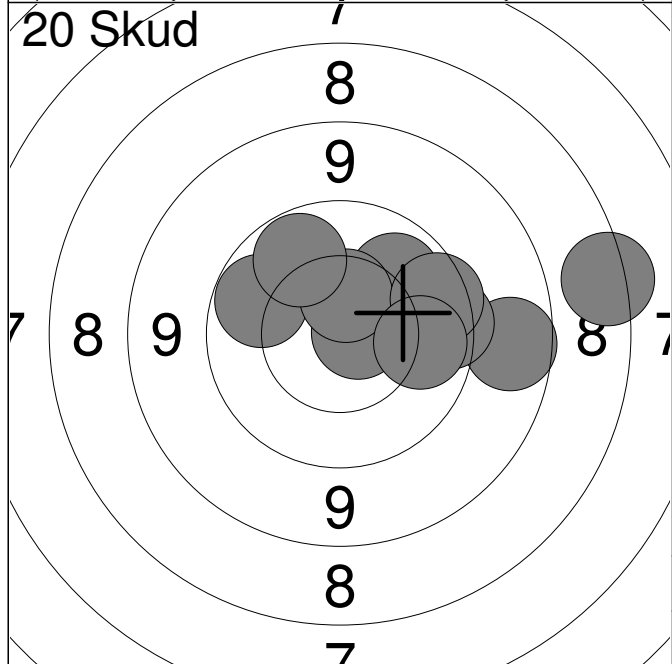

1:	10.0	←
2:	8.9	→
3:	9.7	→
4:	10.7x	→
5:	10.1	↗
6:	10.5	↑
7:	10.0	↗
8:	9.7	→
9:	10.0	→
10:	7.6	→
<b>Serie</b>		<b>93.0</b>
<b>Total</b>		<b>93.0</b>

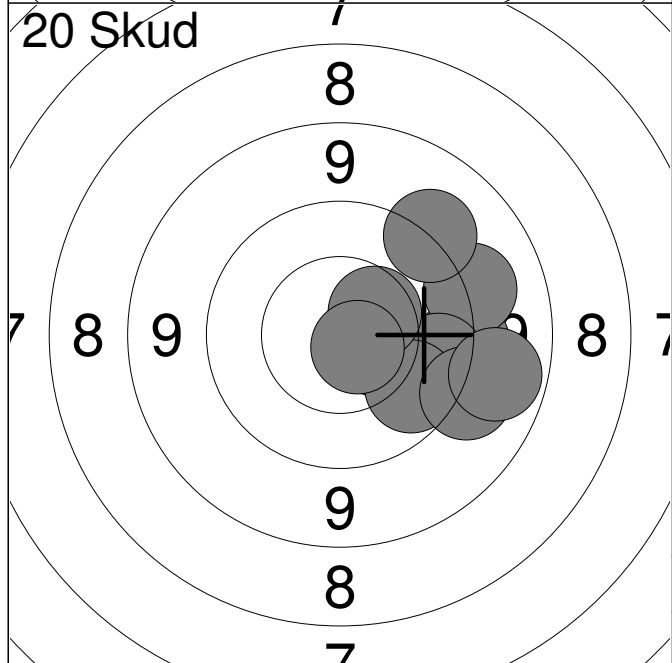

11:	9.5	→
12:	9.3	→
13:	10.5	↘
14:	9.8	→
15:	9.9	↘
16:	10.5	↗
17:	9.3	↘
18:	9.3	↗
19:	10.7x	↘
20:	9.0	→
<b>Serie</b>		<b>93.0</b>
<b>Total</b>		<b>186.0</b>

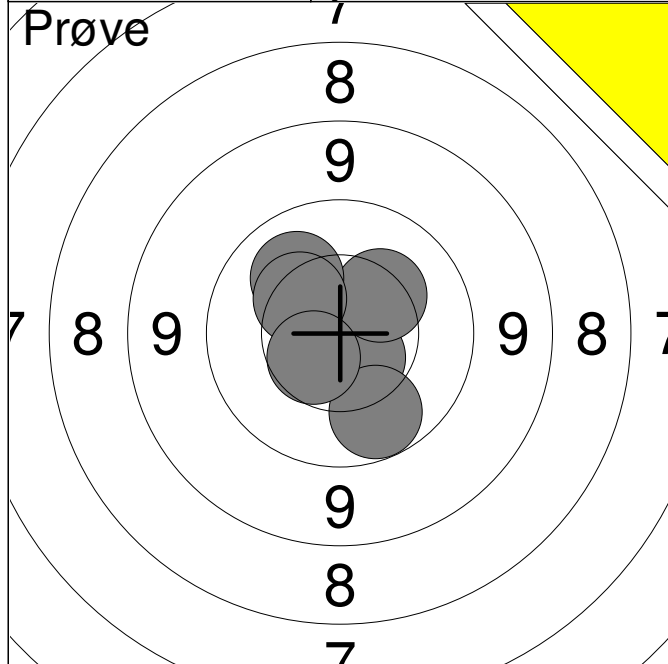

1:	10.6x	↘
2:	9.9	↘
3:	10.3	↗
4:	10.1	↗
5:	10.3	↗
6:	10.5	↘
<b>Serie</b>	<b>59.0</b>	
<b>Total</b>	<b>0.0</b>	

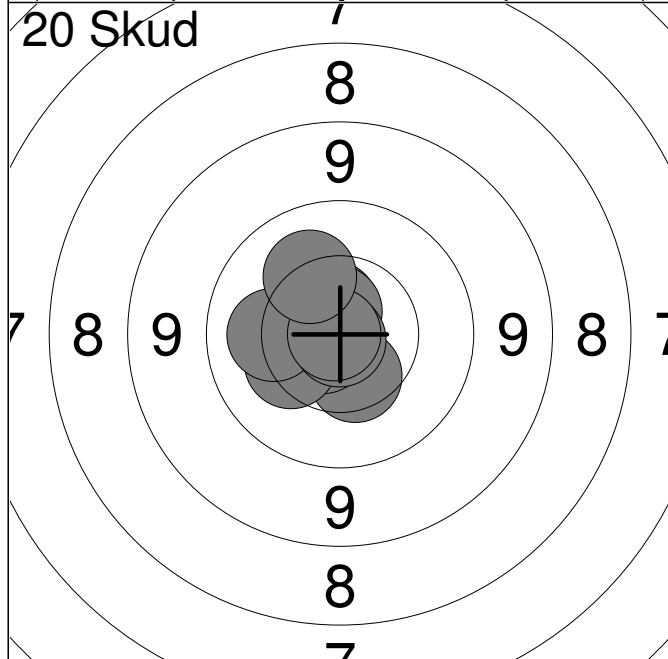

1:	10.4	↘
2:	10.8x	←
3:	10.7x	↘
4:	10.3	←
5:	10.6x	↗
6:	10.7x	↗
7:	10.2	←
8:	10.9x	↘
9:	10.9x	←
10:	10.2	↗
<b>Serie</b>	<b>100.0</b>	
<b>Total</b>	<b>100.0</b>	

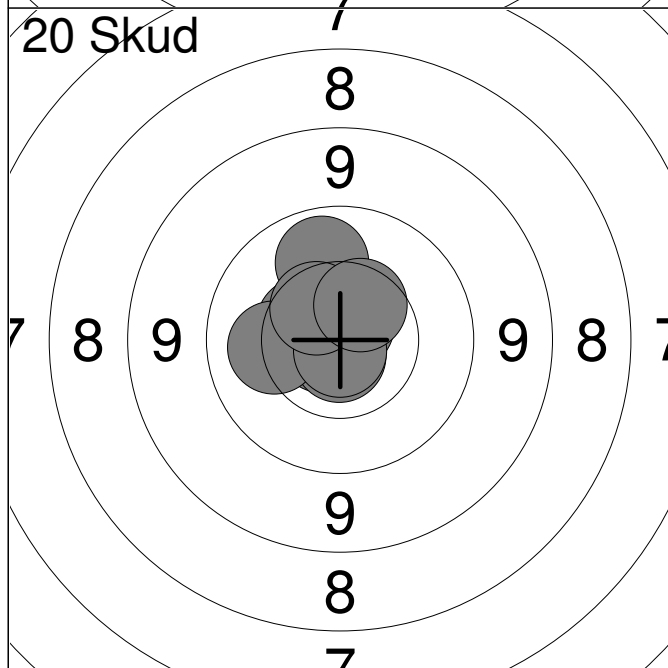

11:	10.7x	←
12:	10.7x	↑
13:	10.8x	↘
14:	10.5	↗
15:	10.2	←
16:	10.8x	↗
17:	10.8x	↘
18:	10.0	↑
19:	10.5	↗
20:	10.5	↗
<b>Serie</b>	<b>100.0</b>	
<b>Total</b>	<b>200.0</b>	

Hold <b>23</b>	Skive <b>1</b>	<b>Jon Jensen</b>
-------------------	-------------------	-------------------

15m	Mou & Omegns Skf.	MB3
-----	-------------------	-----

11.02.2015	Jyllandsstævne 2015	Aalborg Skyttekreds
------------	---------------------	---------------------

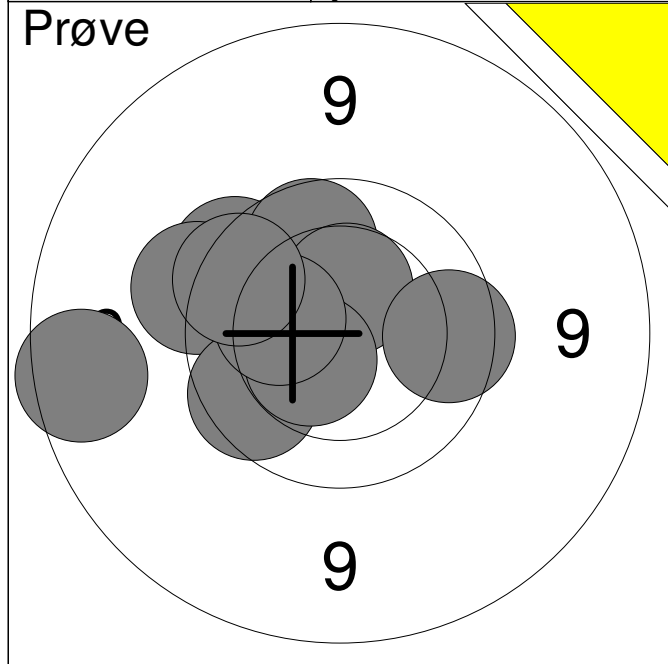

1:	8.9	←
2:	9.7	↗
3:	9.9	↑
4:	9.6	←
5:	9.8	↙
6:	10.4	↑
7:	9.8	→
8:	10.5x	↙
9:	10.2	←
10:	9.8	↗
<b>Serie</b>	<b>92.0</b>	
<b>Total</b>	<b>0.0</b>	

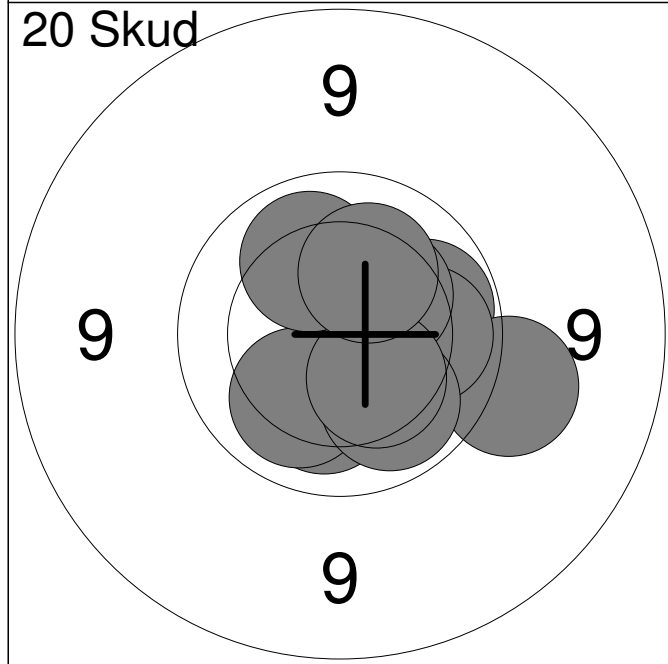

1:	10.0	→
2:	9.4	→
3:	10.2	↓
4:	10.1	↙
5:	10.0	→
6:	10.1	↙
7:	10.3	↗
8:	10.3	↙
9:	10.1	↑
10:	10.2	↑
<b>Serie</b>	<b>99.0</b>	
<b>Total</b>	<b>99.0</b>	

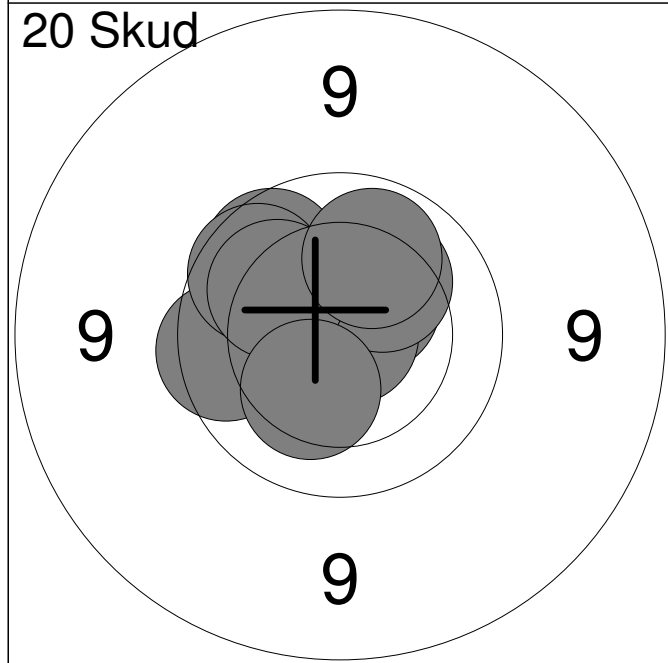

11:	10.5	↗
12:	10.9x	→
13:	10.5x	↗
14:	9.9	↗
15:	9.8	←
16:	10.2	↗
17:	9.9	↗
18:	10.1	↗
19:	10.1	↑
20:	10.3	↙
<b>Serie</b>	<b>97.0</b>	
<b>Total</b>	<b>196.0</b>	

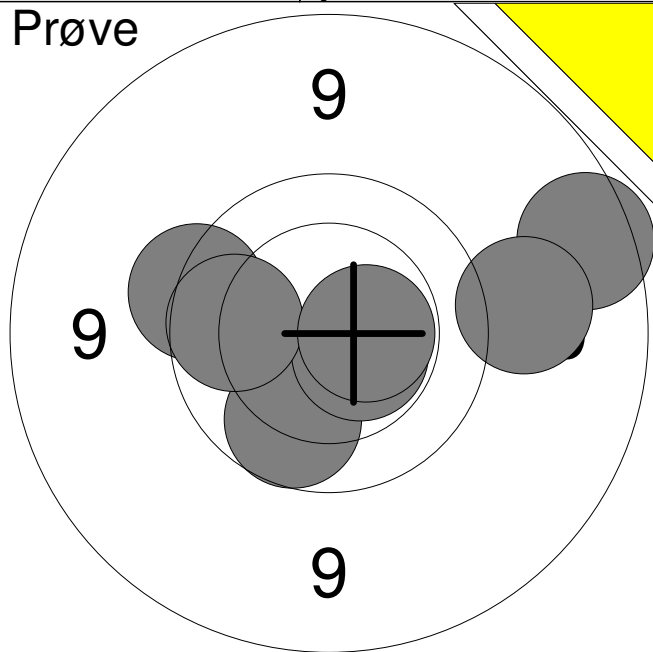
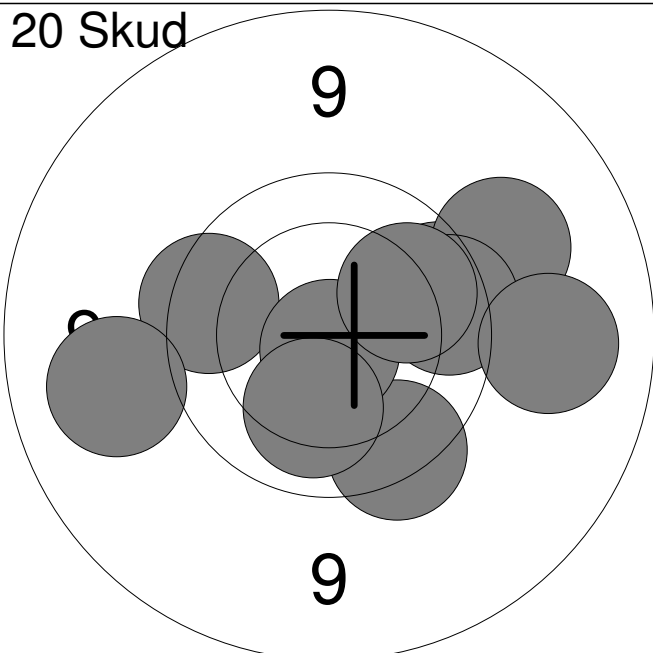
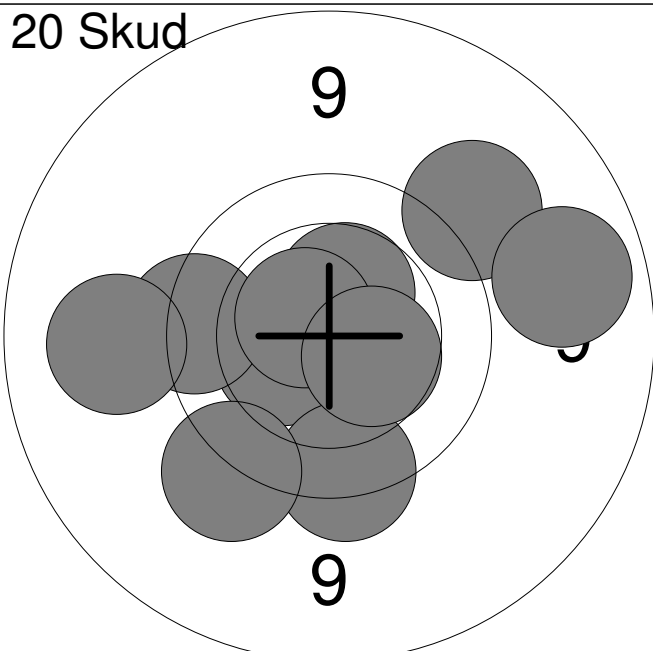
Hold	Skive	Øyvind Jensen	
23	2	15m	Mou & Omegns Skf. MV3
11.02.2015	Jyllandsstævne 2015	Aalborg Skyttekreds	
Prøve		1: 9.9 ↘	
		2: 9.7 ←	
		3: 10.6x ↘	
		4: 8.9 →	
		5: 9.3 →	
		6: 9.9 ←	
		7: 10.5x →	
		<b>Serie</b>	<b>64.0</b>
		<b>Total</b>	<b>0.0</b>
20 Skud		1: 9.8 →	
		2: 9.3 →	
		3: 9.8 ←	
		4: 9.7 ↘	
		5: 10.8x ↘	
		6: 9.2 ←	
		7: 9.8 →	
		8: 10.0 →	
		9: 9.2 →	
		10: 10.1 ↘	
		<b>Serie</b>	<b>93.0</b>
		<b>Total</b>	<b>93.0</b>
20 Skud		11: 10.4 ←	
		12: 9.7 ←	
		13: 9.7 ↘	
		14: 9.3 →	
		15: 10.5 ↑	
		16: 9.2 ←	
		17: 10.6x ↗	
		18: 9.0 →	
		19: 9.5 ↘	
		20: 10.4 ↘	
		<b>Serie</b>	<b>94.0</b>
		<b>Total</b>	<b>187.0</b>

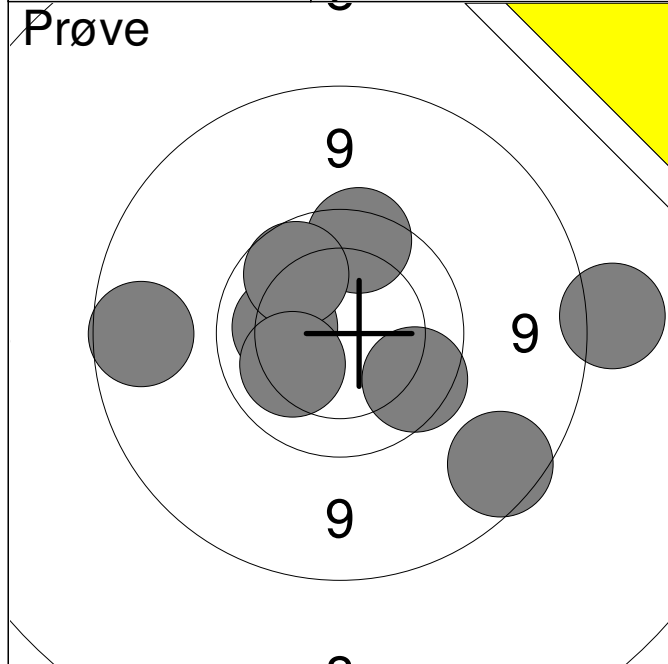

1:	9.8	↑
2:	9.8	↓
3:	8.9	←
4:	8.9	↓
5:	10.2	←
6:	8.5	→
7:	9.9	↗
8:	10.1	↙
<b>Serie</b>		<b>71.0</b>
<b>Total</b>		<b>0.0</b>

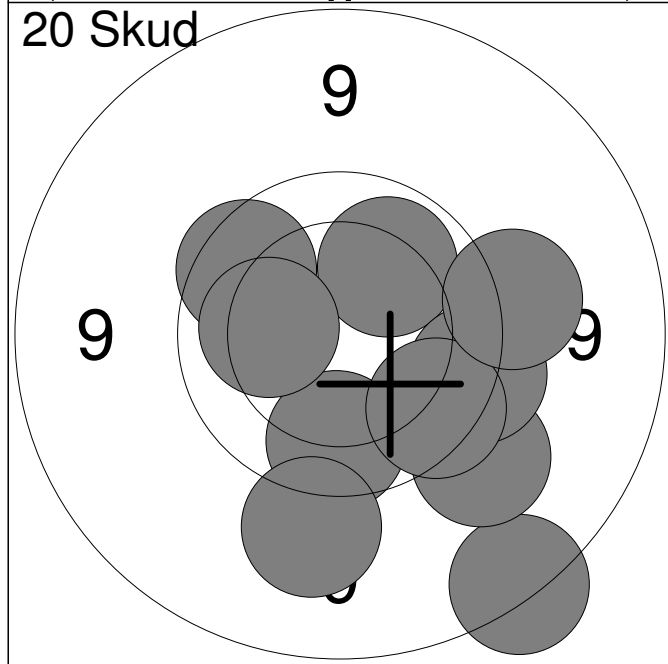

1:	10.1	↗
2:	8.7	↓
3:	9.8	↗
4:	9.9	↓
5:	9.3	↓
6:	9.4	↓
7:	10.2	←
8:	9.6	→
9:	9.8	↓
10:	9.4	→
<b>Serie</b>		<b>91.0</b>
<b>Total</b>		<b>91.0</b>

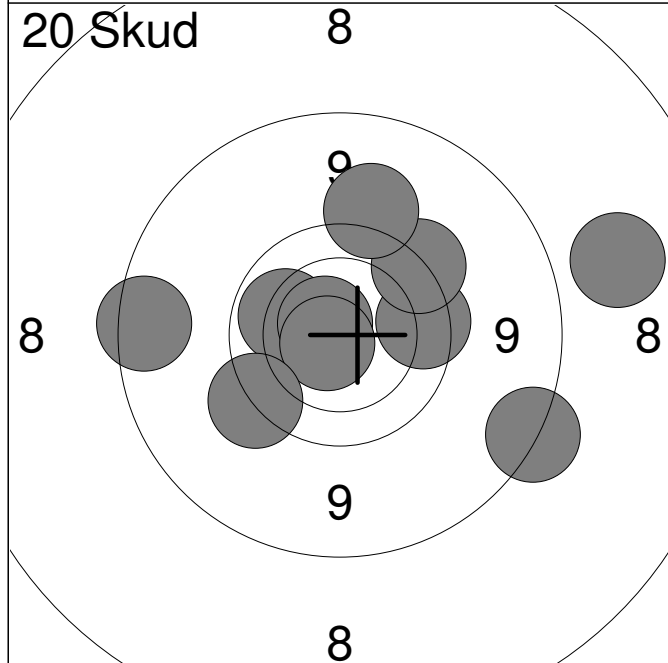

11:	8.3	→
12:	9.8	→
13:	9.6	↗
14:	9.4	↑
15:	10.0	←
16:	8.8	←
17:	10.7x	↗
18:	10.7x	↙
19:	9.6	↙
20:	8.7	↓
<b>Serie</b>		<b>90.0</b>
<b>Total</b>		<b>181.0</b>



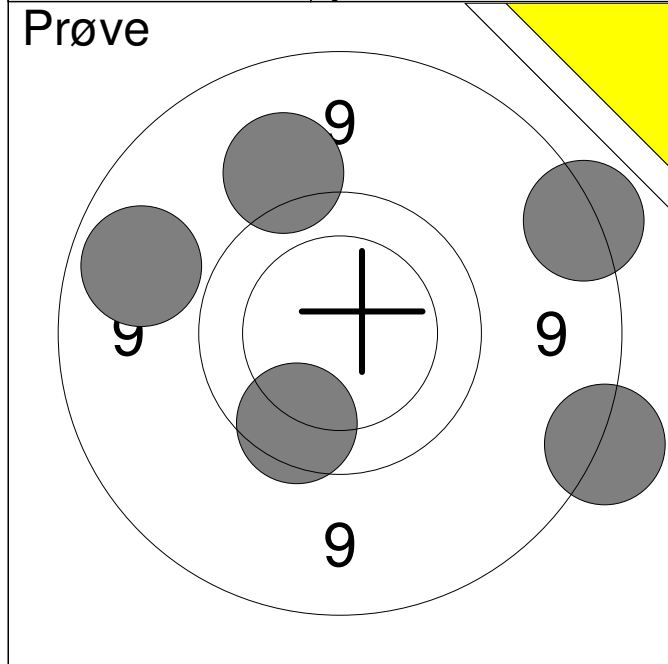

1:	9.0	↖
2:	8.6	↘
3:	8.7	↗
4:	9.3	↖
5:	9.8	↘
<b>Serie</b>		<b>43.0</b>
<b>Total</b>		<b>0.0</b>

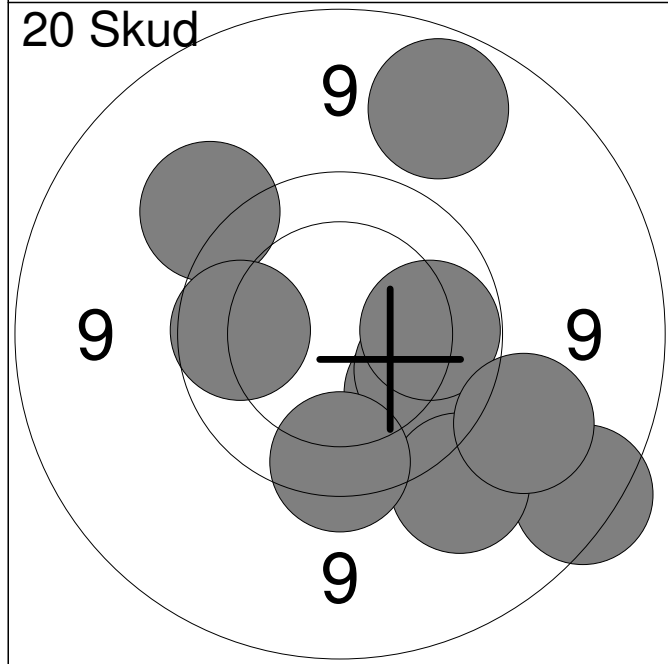

1:	8.8	↘
2:	9.9	↘
3:	9.0	↗
4:	10.0	↘
5:	9.4	↗
6:	9.3	↘
7:	10.0	→
8:	9.9	↖
9:	9.7	↘
10:	9.3	↘
<b>Serie</b>		<b>91.0</b>
<b>Total</b>		<b>91.0</b>

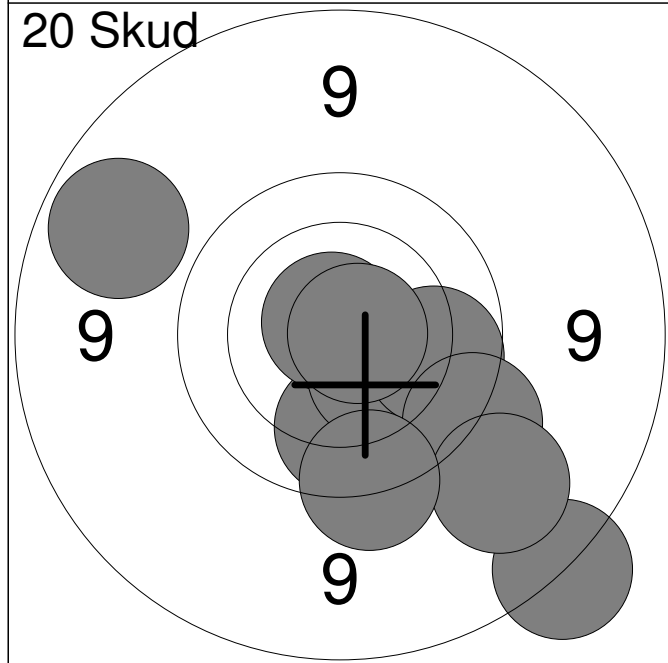

11:	10.0	↘
12:	10.8x	↗
13:	10.4	↘
14:	9.0	↗
15:	9.9	↘
16:	9.5	↘
17:	8.7	↘
18:	9.2	↘
19:	9.6	↘
20:	10.8x	→
<b>Serie</b>		<b>93.0</b>
<b>Total</b>		<b>184.0</b>

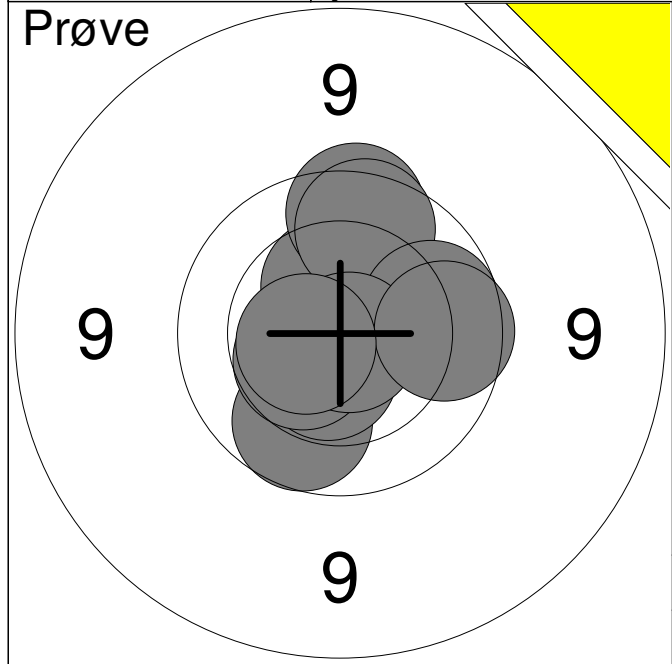

1:	9.9	↙
2:	10.5x	↙
3:	10.5	↙
4:	10.4	↑
5:	9.8	↑
6:	9.9	↑
7:	9.9	→
8:	10.8x	↘
9:	9.9	→
10:	10.6x	←
<b>Serie</b>		<b>95.0</b>
<b>Total</b>		<b>0.0</b>

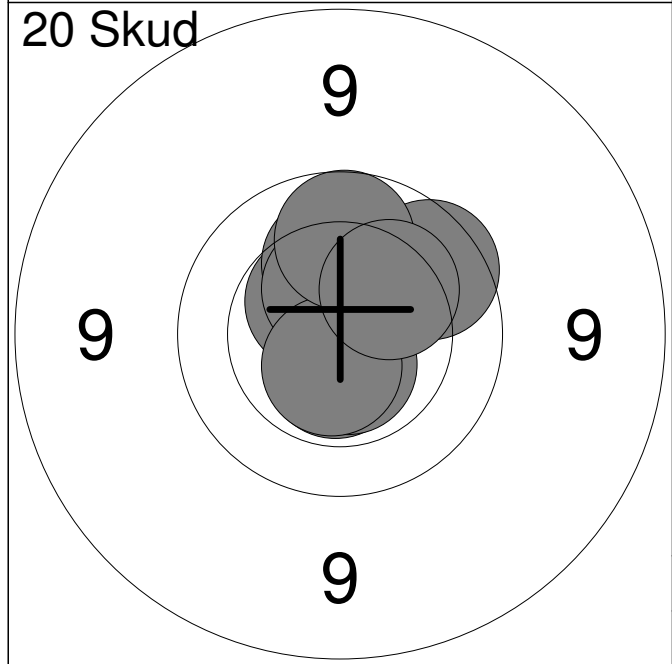

1:	10.5x	↖
2:	10.6x	↘
3:	10.1	↑
4:	10.6x	↘
5:	10.2	↑
6:	9.8	↗
7:	10.5	↑
8:	10.6x	↘
9:	9.9	↑
10:	10.2	↗
<b>Serie</b>		<b>98.0</b>
<b>Total</b>		<b>98.0</b>

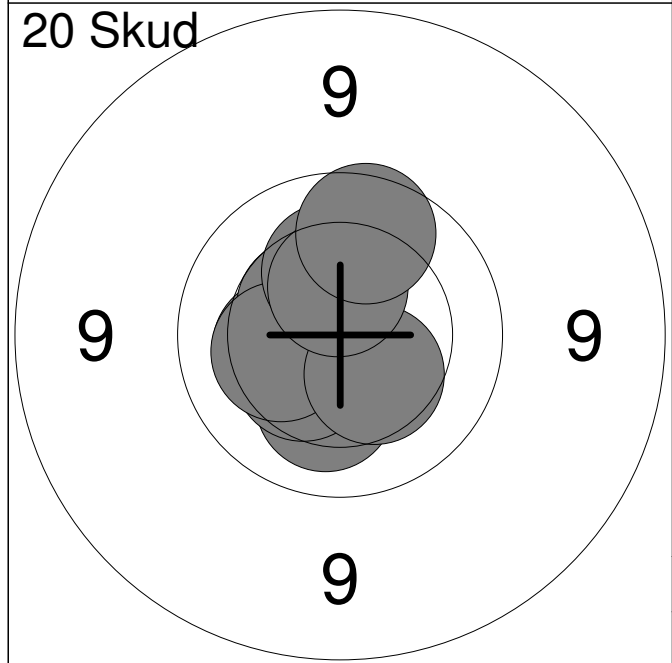

11:	10.2	↘
12:	10.3	←
13:	10.5x	↙
14:	10.5	↗
15:	10.4	↙
16:	10.3	←
17:	10.3	↑
18:	10.4	↘
19:	10.4	↑
20:	9.9	↑
<b>Serie</b>		<b>99.0</b>
<b>Total</b>		<b>197.0</b>

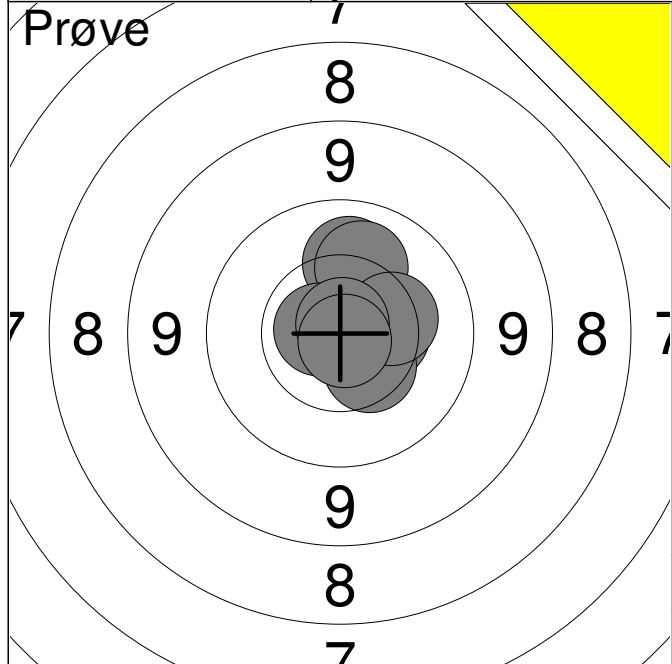

1:	10.1	↑
2:	10.1	↑
3:	10.4	→
4:	10.7x	←
5:	10.4	↘
6:	10.3	→
7:	10.8x	↑
8:	10.9x	↘
<b>Serie</b>		<b>80.0</b>
<b>Total</b>		<b>0.0</b>

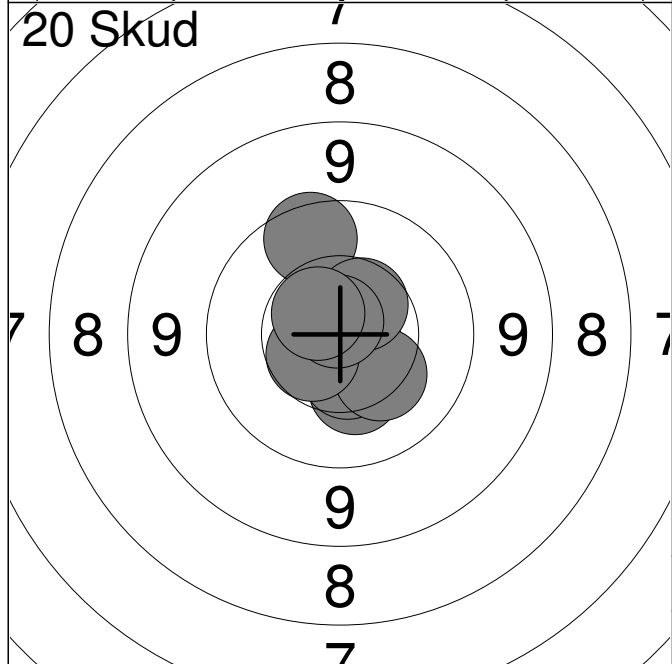

1:	10.3	↘
2:	10.6x	↘
3:	10.5	↘
4:	10.3	↘
5:	10.6	↙
6:	10.6x	↑
7:	9.8	↑
8:	10.5	↗
9:	10.8x	↑
10:	10.6x	↗
<b>Serie</b>		<b>99.0</b>
<b>Total</b>		<b>99.0</b>

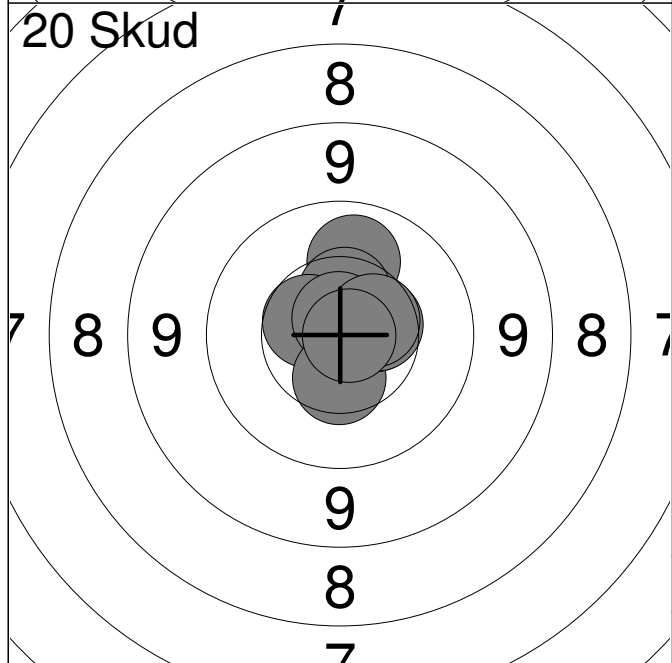

11:	10.1	↑
12:	10.5	↑
13:	10.9x	↘
14:	10.6	↖
15:	10.8x	↑
16:	10.5	↘
17:	10.5	→
18:	10.5	→
19:	10.5	→
20:	10.8x	→
<b>Serie</b>		<b>100.0</b>
<b>Total</b>		<b>199.0</b>

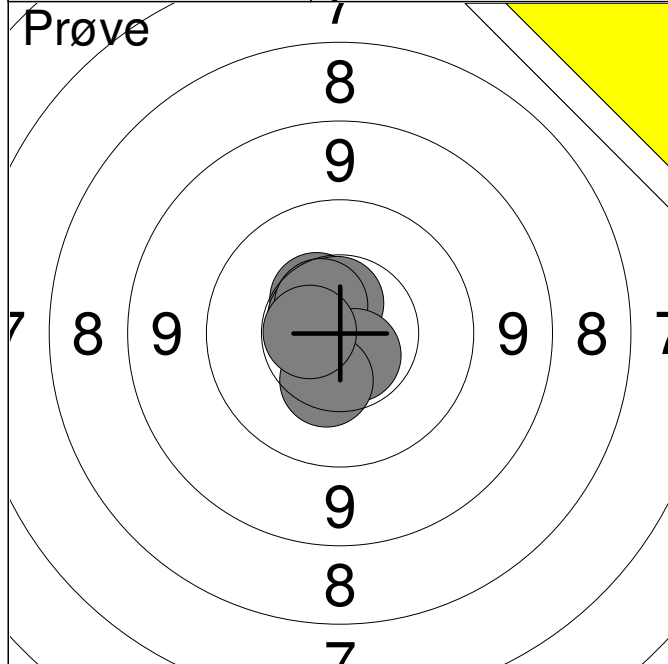

1:	10.5	↗
2:	10.6x	↗
3:	10.6x	↑
4:	10.6	↗
5:	10.6x	↘
6:	10.4	↘
7:	10.6x	←
<b>Serie</b>		<b>70.0</b>
<b>Total</b>		<b>0.0</b>

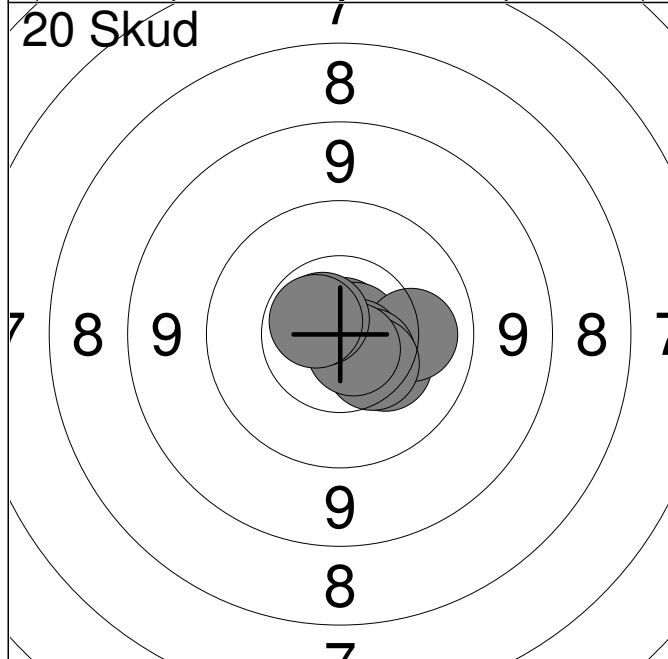

1:	10.3	↘
2:	10.8x	↑
3:	10.8x	→
4:	10.1	→
5:	10.7x	↘
6:	10.5	↘
7:	10.4	↘
8:	10.7x	↘
9:	10.7x	↗
10:	10.6x	↗
<b>Serie</b>		<b>100.0</b>
<b>Total</b>		<b>100.0</b>

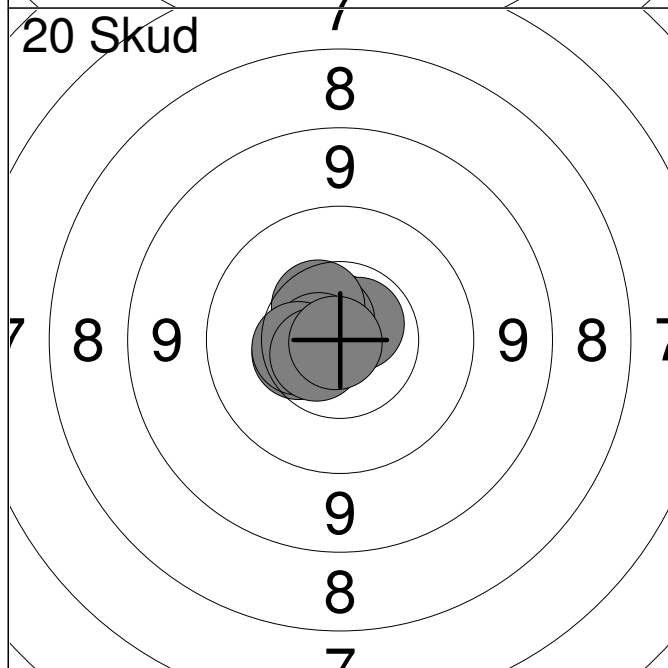

11:	10.4	←
12:	10.6x	↗
13:	10.7x	↑
14:	10.7x	↗
15:	10.7x	↗
16:	10.5	↗
17:	10.7x	←
18:	10.5	←
19:	10.6x	↘
20:	10.9x	↘
<b>Serie</b>		<b>100.0</b>
<b>Total</b>		<b>200.0</b>

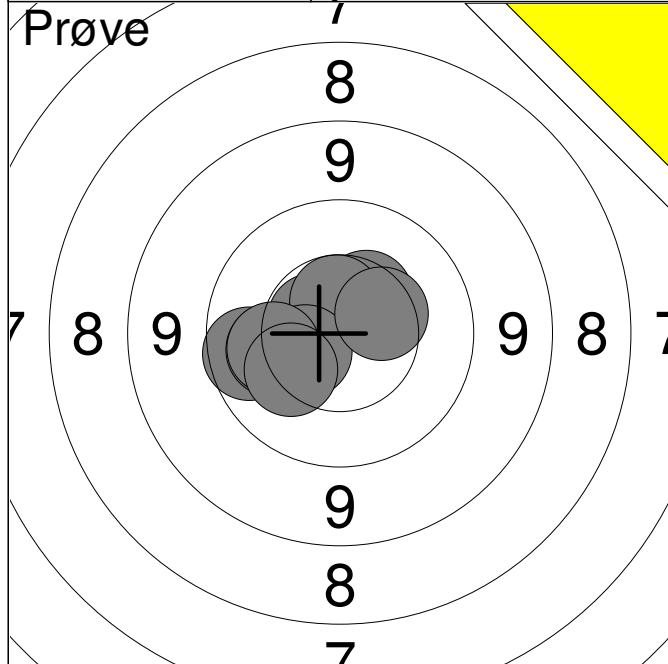

1:	10.4	↗
2:	10.6x	↖
3:	10.6	↑
4:	10.5	↖
5:	9.9	↖
6:	10.1	↖
7:	10.2	↖
8:	10.2	↖
9:	10.4	↗
<b>Serie</b>	<b>89.0</b>	
<b>Total</b>	<b>0.0</b>	

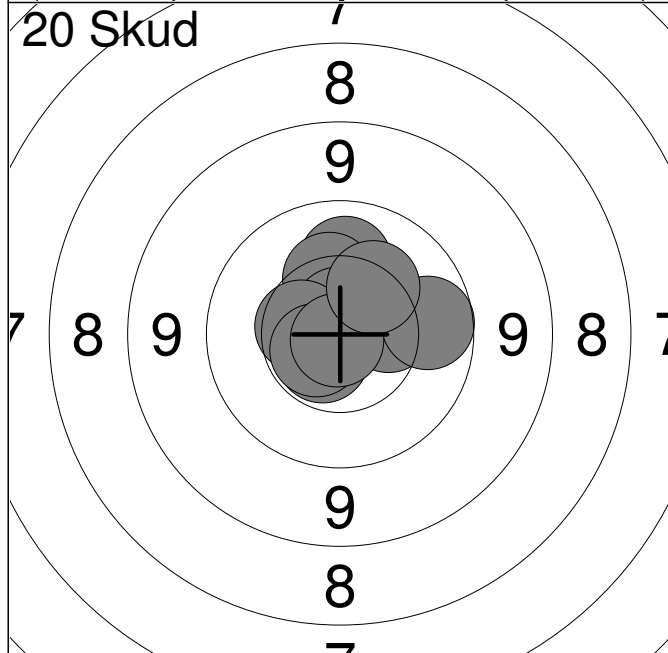

1:	10.4	→
2:	10.1	↑
3:	10.3	↑
4:	10.7x	↑
5:	10.6x	↖
6:	10.5	↖
7:	9.9	→
8:	10.6x	↖
9:	10.9x	↖
10:	10.3	↗
<b>Serie</b>	<b>99.0</b>	
<b>Total</b>	<b>99.0</b>	

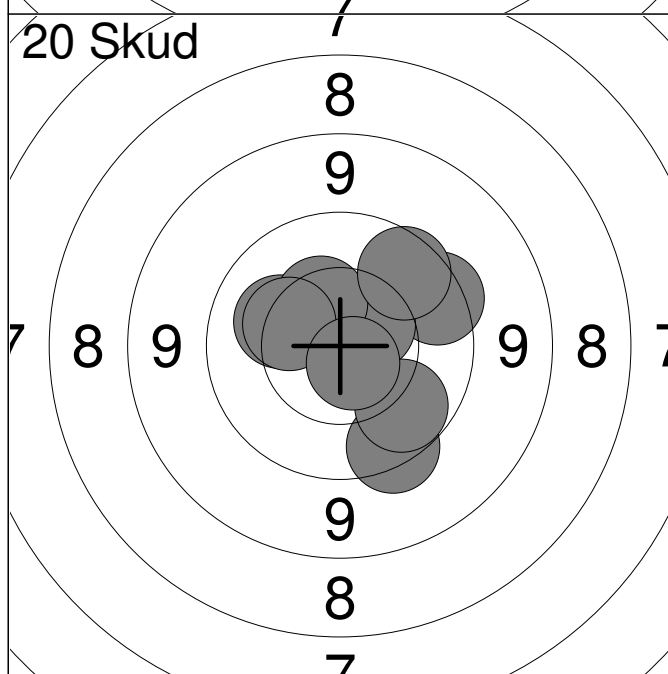

11:	10.2	↖
12:	10.8x	↑
13:	9.7	↗
14:	10.5	↗
15:	9.6	↘
16:	10.4	↑
17:	9.8	↗
18:	10.3	↖
19:	10.0	↘
20:	10.7x	↘
<b>Serie</b>	<b>97.0</b>	
<b>Total</b>	<b>196.0</b>	

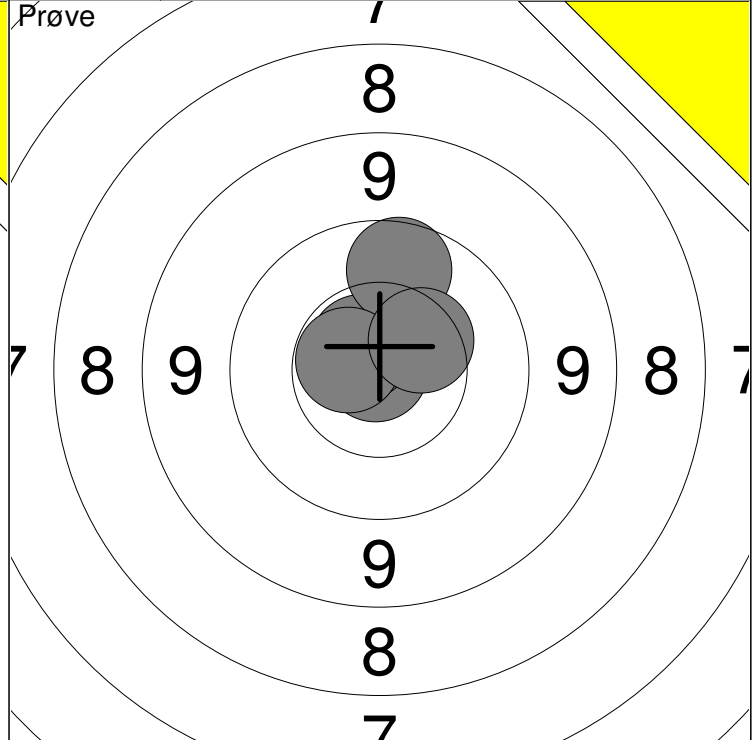
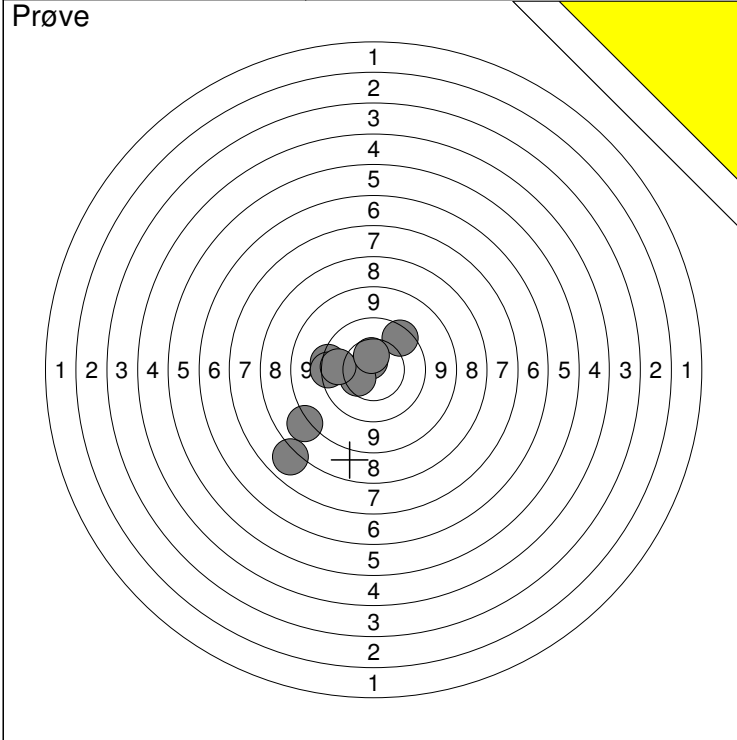

1: 0.0 ↓	6: 9.7 ↗	Serie	81
2: 7.1 ↙	7: 10.7x ↖		
3: 8.2 ↙	8: 10.4 ↙	Total	0
4: 9.6 ←	9: 9.9 ←		
5: 9.6 ←	10: 10.5 ↑		

11: 10.9x ←	Serie	49
12: 10.7x ↖		
13: 9.9 ↑	Total	0
14: 10.6x ↙		
15: 10.4 ↗		

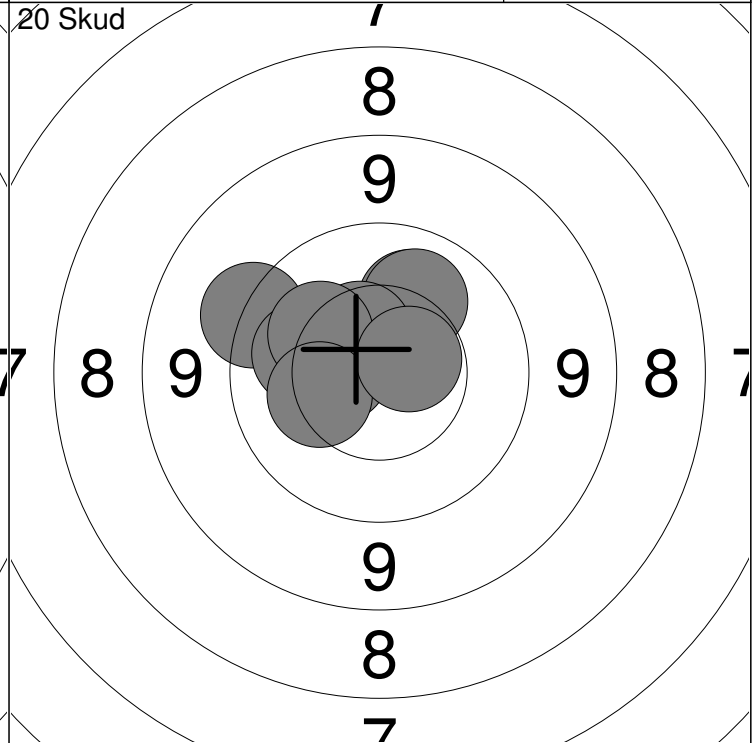
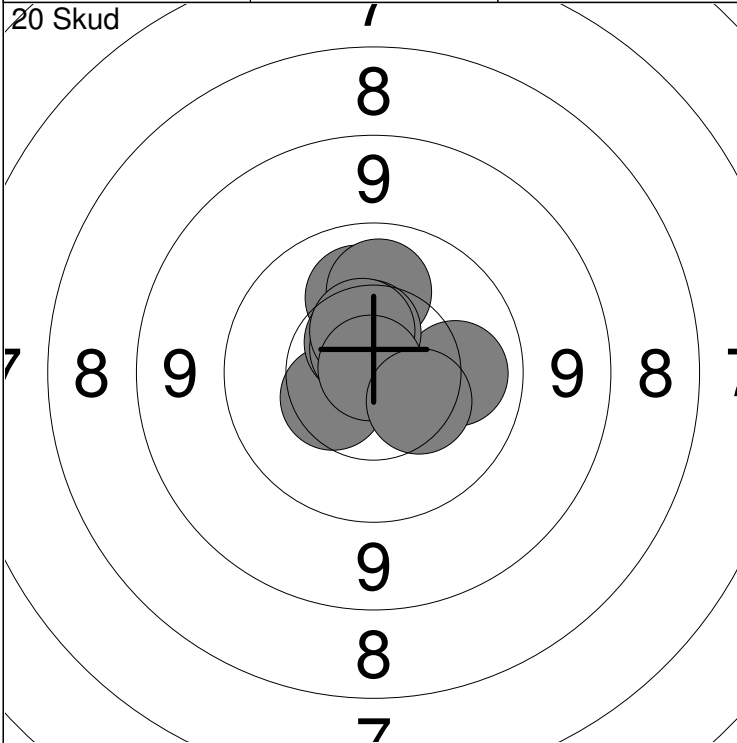

1: 10.1 →	6: 10.1 ↑	Serie	100
2: 10.2 ↑	7: 10.5 ↑		
3: 10.5 ↙	8: 10.5 ↑	Total	100
4: 10.6x ↖	9: 10.9x ↖		
5: 10.7x ↖	10: 10.4 ↘		

11: 9.5 ↙	16: 10.5 ↖	Serie	99
12: 10.2 ↑	17: 10.2 ←		
13: 10.1 ↖	18: 10.2 ↙	Total	199
14: 10.6 ↙	19: 10.3 ←		
15: 10.5 ←	20: 10.6x ↗		

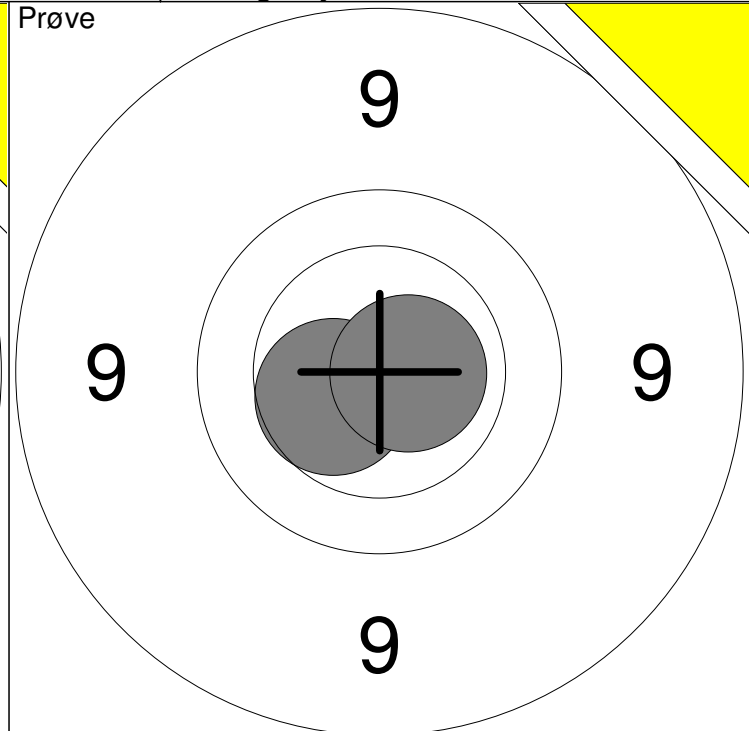
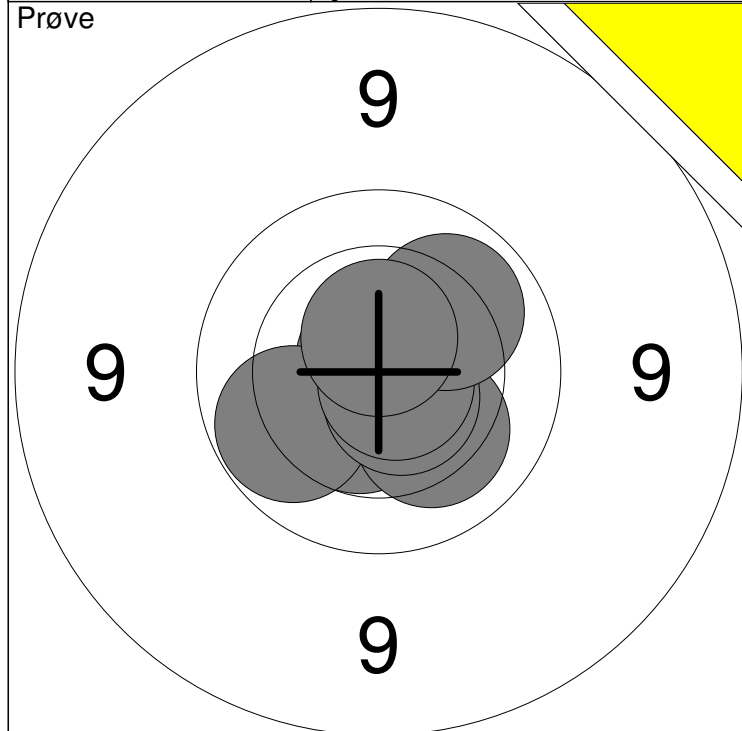

1: 10.7x →	6: 10.2 ↘	Serie	100
2: 10.8x ↗	7: 10.6x ↘		
3: 10.7x ↘	8: 10.8x ↘	Total	0
4: 10.5x ↘	9: 10.1 ↗		
5: 10.0 ↙	10: 10.6x ↑		

11: 10.4 ↙	Serie	20
12: 10.7x →		
Total		0

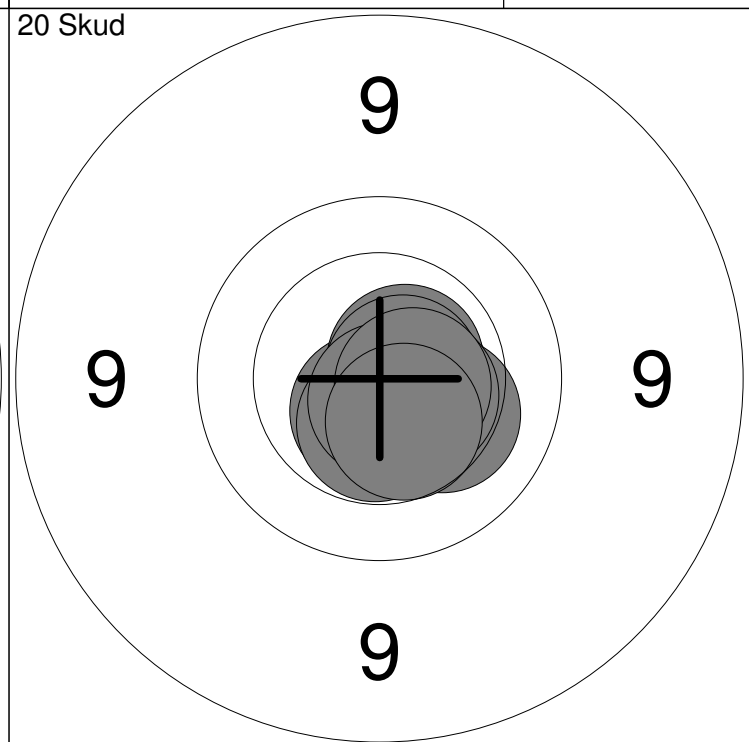
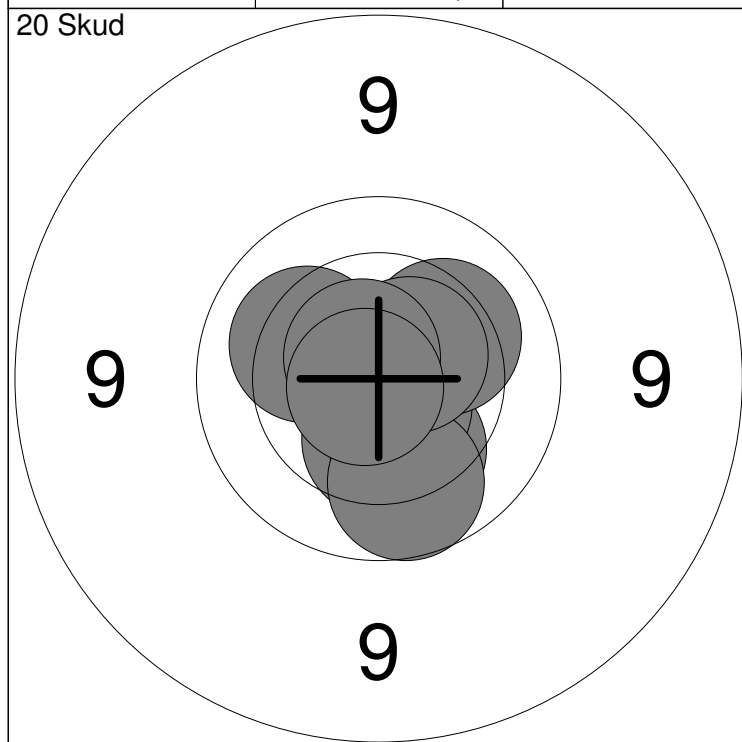

1: 10.4 ↓	6: 10.7x ↖	Serie	99
2: 10.2 ↓	7: 10.6x ↗		
3: 10.7x ↓	8: 10.2 ↖	Total	99
4: 9.9 ↓	9: 10.7x ↗		
5: 10.2 ↗	10: 10.8x ↙		

11: 10.6x ↓	16: 10.7x →	Serie	100
12: 10.6x →	17: 10.5x ↘		
13: 10.3 ↘	18: 10.7x ↓	Total	199
14: 10.7x ↗	19: 10.6x →		
15: 10.5x ↓	20: 10.5 ↓		

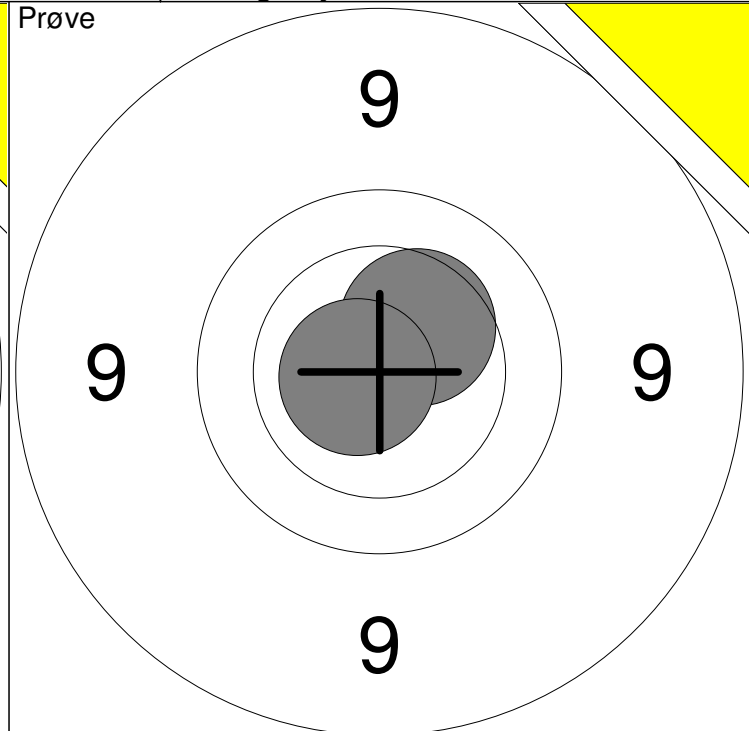
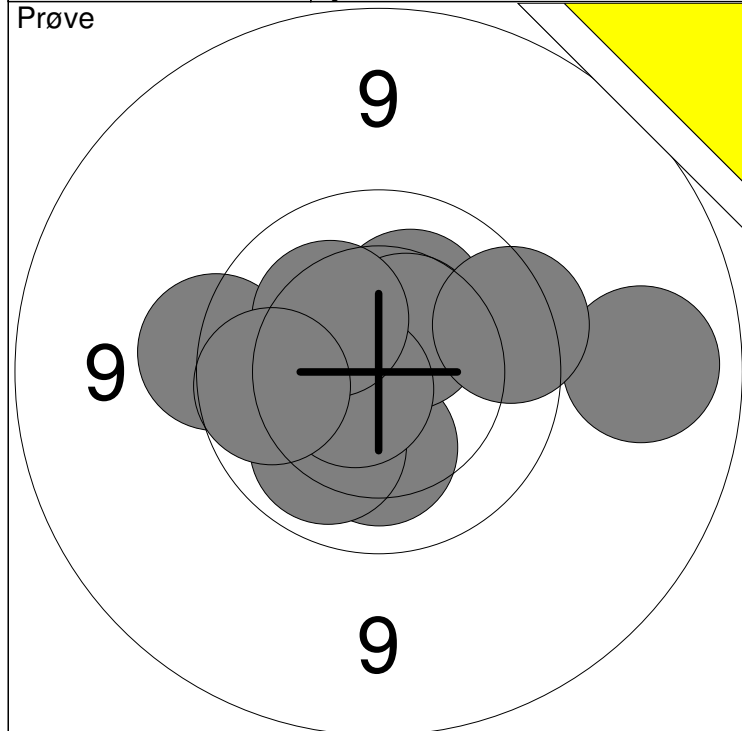

1: 9.1 →	6: 9.7 →	Serie	96
2: 10.2 ↓	7: 10.7x ↙		
3: 10.1 ↙	8: 9.6 ←	Total	0
4: 10.3 ↗	9: 10.3 ↗		
5: 10.5 ↗	10: 9.9 ←		

11: 10.4 ↗	Serie	20
12: 10.7x ←		
Total		0

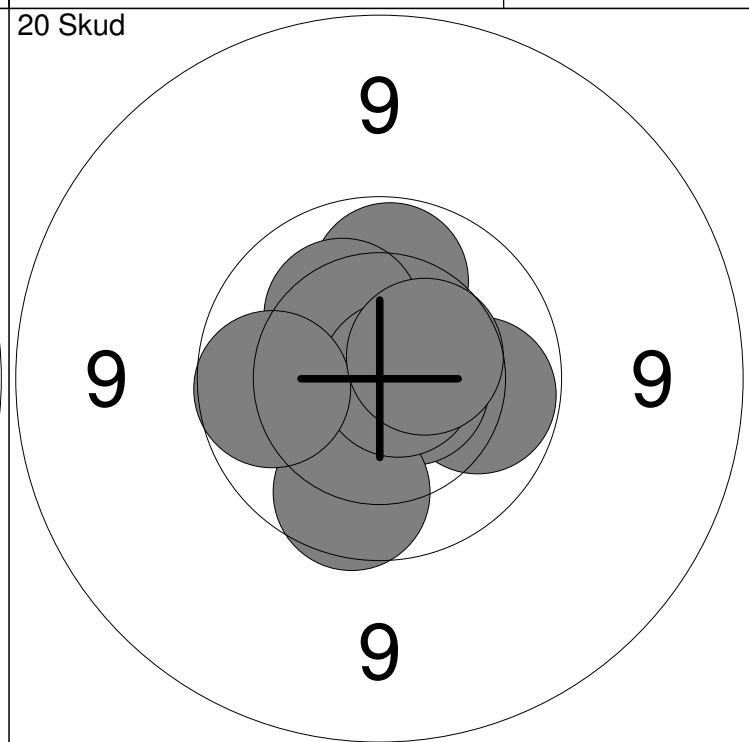
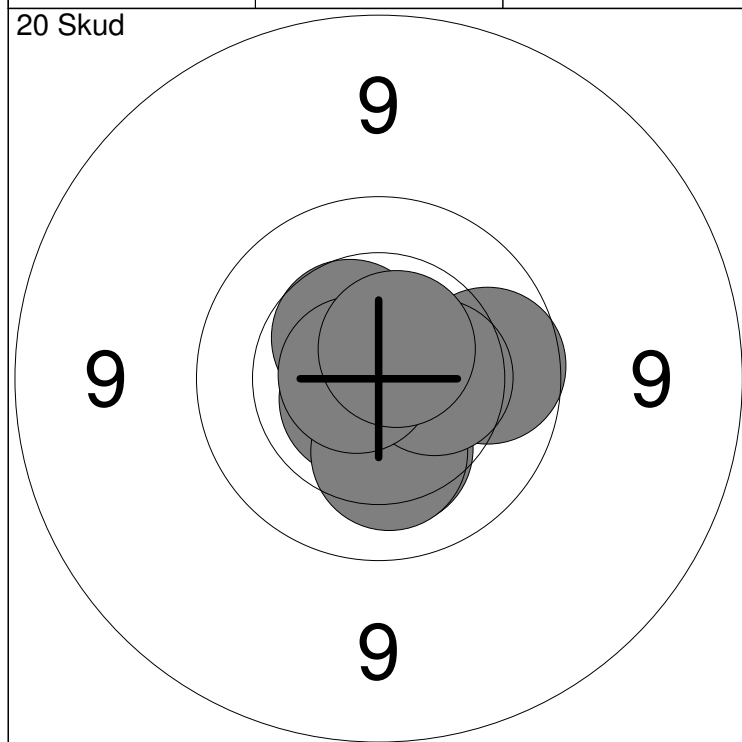

1: 10.6x ↗	6: 10.5 ↗	Serie	99
2: 10.7x ↙	7: 10.2 ↓		
3: 9.9 →	8: 10.4 →	Total	99
4: 10.8x ↗	9: 10.7x ←		
5: 10.3 ↓	10: 10.6x ↗		

11: 10.0 →	16: 10.3 ↗	Serie	98
12: 10.5x ↗	17: 9.9 ↓		
13: 10.6x →	18: 10.8x →	Total	197
14: 10.6x →	19: 9.9 ←		
15: 10.0 ↑	20: 10.5 ↗		

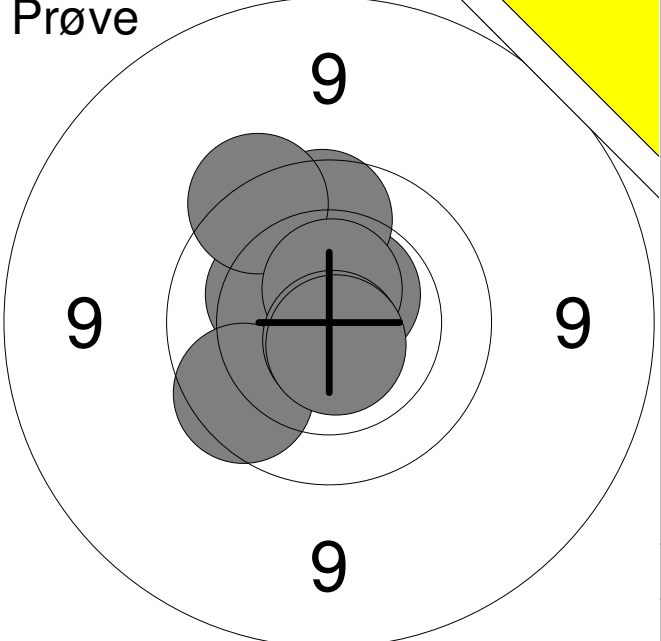

<p><b>Prøve</b></p> 	<table style="width:100%; border-collapse: collapse;"> <tr><td style="width:10%;">1:</td><td style="width:80%;">10.6x</td><td style="width:10%; text-align: right;">↗</td></tr> <tr><td>2:</td><td>10.3</td><td style="text-align: right;">↖</td></tr> <tr><td>3:</td><td>9.9</td><td style="text-align: right;">↑</td></tr> <tr><td>4:</td><td>9.7</td><td style="text-align: right;">↖</td></tr> <tr><td>5:</td><td>10.6x</td><td style="text-align: right;">↑</td></tr> <tr><td>6:</td><td>9.8</td><td style="text-align: right;">↖</td></tr> <tr><td>7:</td><td>10.7x</td><td style="text-align: right;">↓</td></tr> <tr><td>8:</td><td>10.7x</td><td style="text-align: right;">↓</td></tr> <tr><td colspan="2"><b>Serie</b></td><td style="text-align: right;"><b>77.0</b></td></tr> <tr><td colspan="2"><b>Total</b></td><td style="text-align: right;"><b>0.0</b></td></tr> </table>	1:	10.6x	↗	2:	10.3	↖	3:	9.9	↑	4:	9.7	↖	5:	10.6x	↑	6:	9.8	↖	7:	10.7x	↓	8:	10.7x	↓	<b>Serie</b>		<b>77.0</b>	<b>Total</b>		<b>0.0</b>
1:	10.6x	↗																													
2:	10.3	↖																													
3:	9.9	↑																													
4:	9.7	↖																													
5:	10.6x	↑																													
6:	9.8	↖																													
7:	10.7x	↓																													
8:	10.7x	↓																													
<b>Serie</b>		<b>77.0</b>																													
<b>Total</b>		<b>0.0</b>																													

<p><b>20 Skud</b></p> 	<table style="width:100%; border-collapse: collapse;"> <tr><td style="width:10%;">1:</td><td style="width:80%;">10.2</td><td style="width:10%; text-align: right;">→</td></tr> <tr><td>2:</td><td>10.3</td><td style="text-align: right;">↗</td></tr> <tr><td>3:</td><td>10.3</td><td style="text-align: right;">↗</td></tr> <tr><td>4:</td><td>9.8</td><td style="text-align: right;">→</td></tr> <tr><td>5:</td><td>9.9</td><td style="text-align: right;">↖</td></tr> <tr><td>6:</td><td>10.0</td><td style="text-align: right;">←</td></tr> <tr><td>7:</td><td>10.4</td><td style="text-align: right;">→</td></tr> <tr><td>8:</td><td>10.1</td><td style="text-align: right;">↓</td></tr> <tr><td>9:</td><td>10.0</td><td style="text-align: right;">→</td></tr> <tr><td>10:</td><td>10.3</td><td style="text-align: right;">↗</td></tr> <tr><td colspan="2"><b>Serie</b></td><td style="text-align: right;"><b>98.0</b></td></tr> <tr><td colspan="2"><b>Total</b></td><td style="text-align: right;"><b>98.0</b></td></tr> </table>	1:	10.2	→	2:	10.3	↗	3:	10.3	↗	4:	9.8	→	5:	9.9	↖	6:	10.0	←	7:	10.4	→	8:	10.1	↓	9:	10.0	→	10:	10.3	↗	<b>Serie</b>		<b>98.0</b>	<b>Total</b>		<b>98.0</b>
1:	10.2	→																																			
2:	10.3	↗																																			
3:	10.3	↗																																			
4:	9.8	→																																			
5:	9.9	↖																																			
6:	10.0	←																																			
7:	10.4	→																																			
8:	10.1	↓																																			
9:	10.0	→																																			
10:	10.3	↗																																			
<b>Serie</b>		<b>98.0</b>																																			
<b>Total</b>		<b>98.0</b>																																			

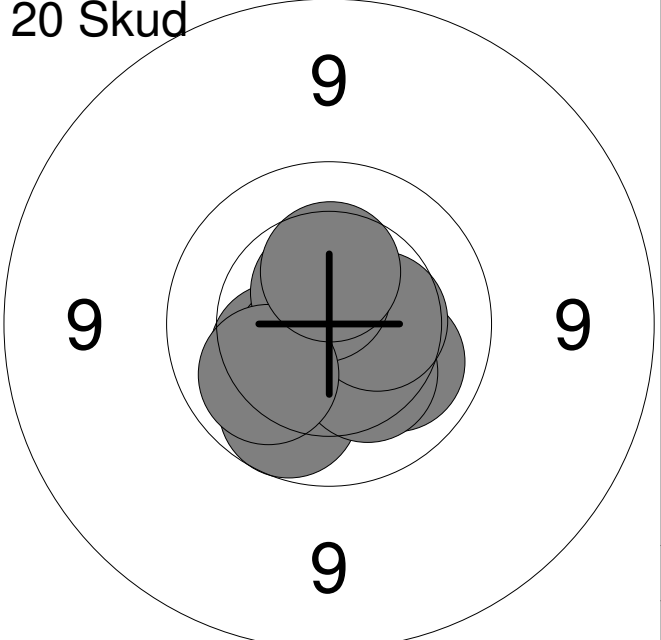
<p><b>20 Skud</b></p> 	<table style="width:100%; border-collapse: collapse;"> <tr><td style="width:10%;">11:</td><td style="width:80%;">9.9</td><td style="width:10%; text-align: right;">↙</td></tr> <tr><td>12:</td><td>10.3</td><td style="text-align: right;">↖</td></tr> <tr><td>13:</td><td>10.1</td><td style="text-align: right;">↘</td></tr> <tr><td>14:</td><td>10.5x</td><td style="text-align: right;">↙</td></tr> <tr><td>15:</td><td>10.3</td><td style="text-align: right;">↘</td></tr> <tr><td>16:</td><td>10.7x</td><td style="text-align: right;">↗</td></tr> <tr><td>17:</td><td>10.4</td><td style="text-align: right;">→</td></tr> <tr><td>18:</td><td>10.6x</td><td style="text-align: right;">↑</td></tr> <tr><td>19:</td><td>10.1</td><td style="text-align: right;">↖</td></tr> <tr><td>20:</td><td>10.4</td><td style="text-align: right;">↑</td></tr> <tr><td colspan="2"><b>Serie</b></td><td style="text-align: right;"><b>99.0</b></td></tr> <tr><td colspan="2"><b>Total</b></td><td style="text-align: right;"><b>197.0</b></td></tr> </table>	11:	9.9	↙	12:	10.3	↖	13:	10.1	↘	14:	10.5x	↙	15:	10.3	↘	16:	10.7x	↗	17:	10.4	→	18:	10.6x	↑	19:	10.1	↖	20:	10.4	↑	<b>Serie</b>		<b>99.0</b>	<b>Total</b>		<b>197.0</b>
11:	9.9	↙																																			
12:	10.3	↖																																			
13:	10.1	↘																																			
14:	10.5x	↙																																			
15:	10.3	↘																																			
16:	10.7x	↗																																			
17:	10.4	→																																			
18:	10.6x	↑																																			
19:	10.1	↖																																			
20:	10.4	↑																																			
<b>Serie</b>		<b>99.0</b>																																			
<b>Total</b>		<b>197.0</b>																																			

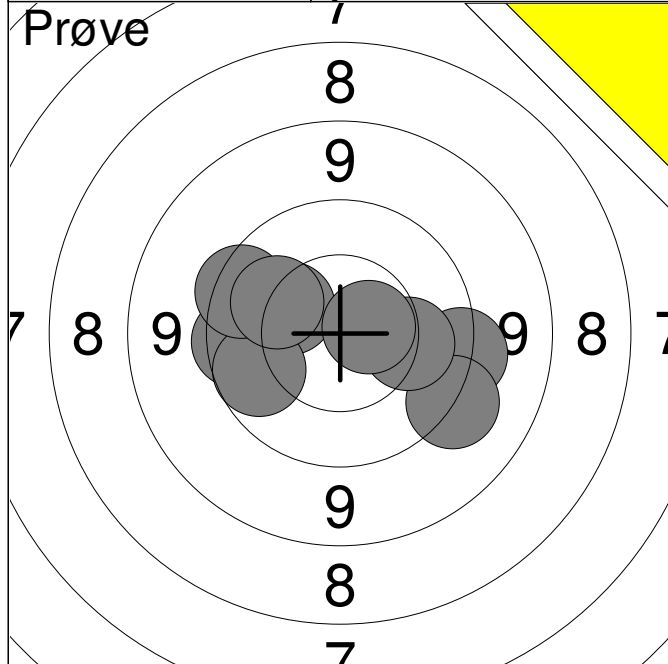

1:	9.7	←
2:	10.3	↗
3:	9.5	→
4:	9.9	←
5:	9.4	↘
6:	10.2	→
7:	10.6x	→
8:	9.7	↗
9:	10.1	↗

<b>Serie</b>	<b>85.0</b>
<b>Total</b>	<b>0.0</b>

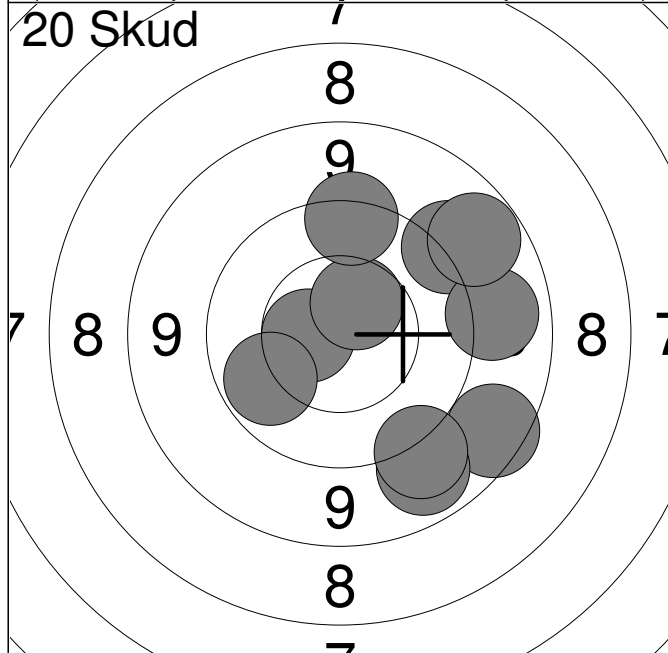

1:	9.3	↗
2:	10.6	←
3:	8.8	↘
4:	9.1	→
5:	9.0	↘
6:	9.0	↗
7:	10.0	←
8:	10.5	↗
9:	9.6	↑
10:	9.2	↘

<b>Serie</b>	<b>92.0</b>
<b>Total</b>	<b>92.0</b>

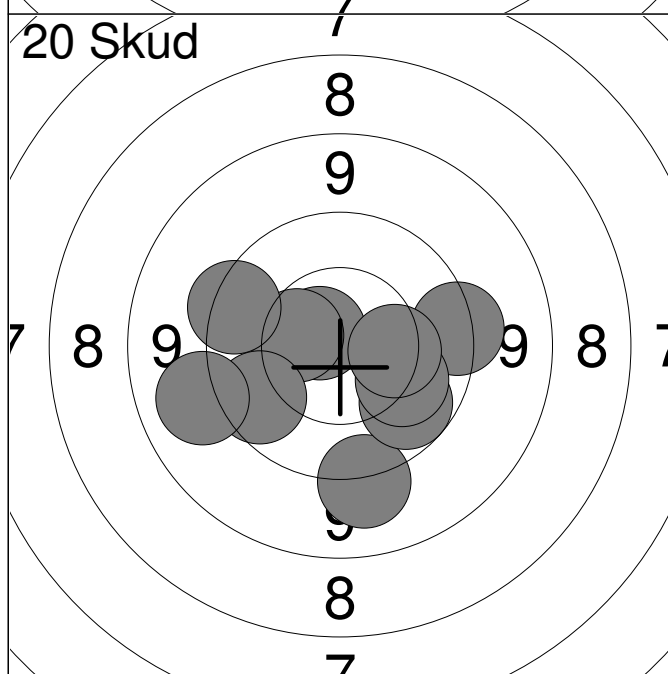

11:	9.3	↘
12:	10.7x	↗
13:	10.4	←
14:	9.8	←
15:	9.5	→
16:	9.9	↘
17:	10.1	↘
18:	9.6	↗
19:	9.2	←
20:	10.3	→

<b>Serie</b>	<b>94.0</b>
<b>Total</b>	<b>186.0</b>

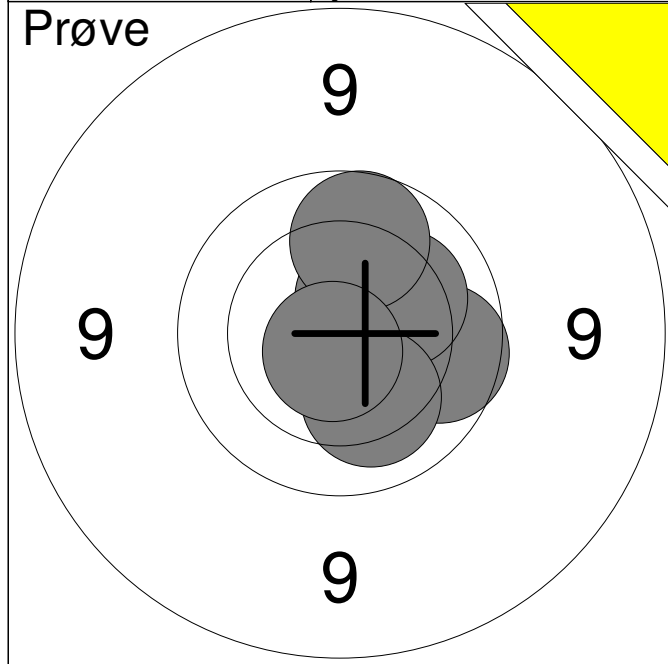

1:	10.2	→
2:	10.3	→
3:	10.5x	↗
4:	9.9	→
5:	10.2	↗
6:	9.9	↑
7:	10.2	↓
8:	10.7x	↓
<b>Serie</b>		<b>78.0</b>
<b>Total</b>		<b>0.0</b>

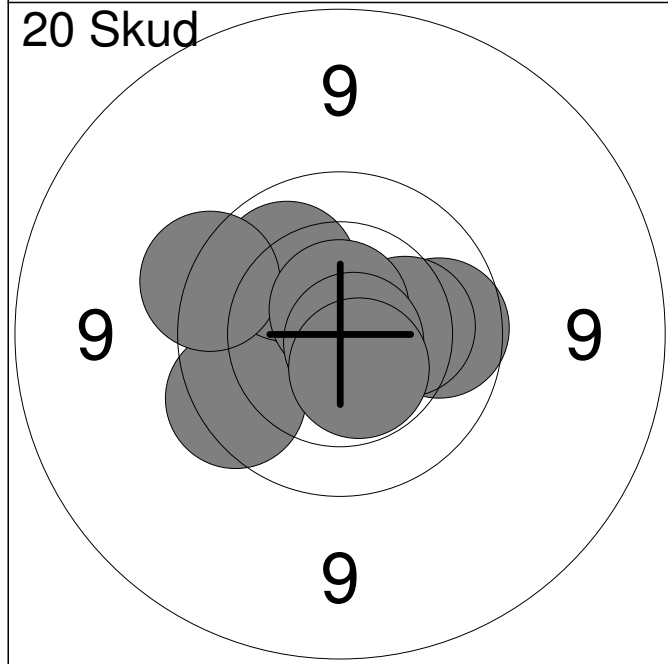

1:	10.3	←
2:	9.9	→
3:	10.6x	←
4:	9.8	↙
5:	10.1	↗
6:	9.7	↖
7:	10.2	→
8:	10.7x	↑
9:	10.8x	↘
10:	10.5x	↓
<b>Serie</b>		<b>97.0</b>
<b>Total</b>		<b>97.0</b>

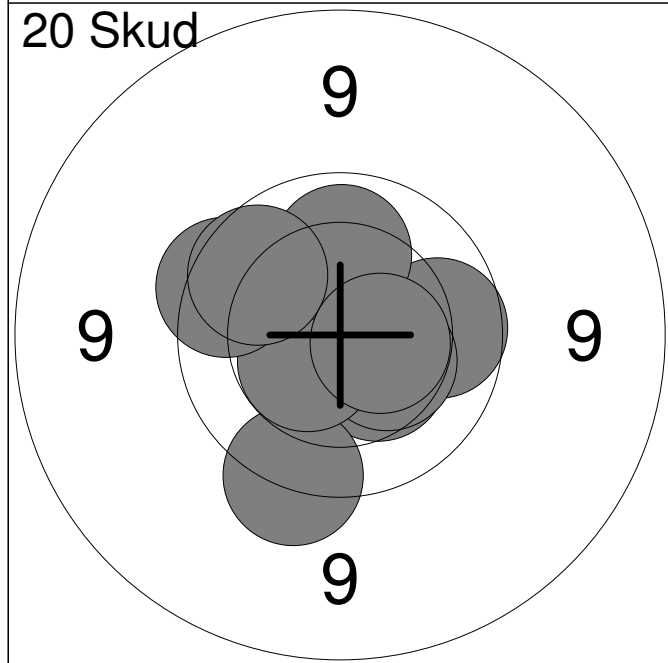

11:	10.4	↘
12:	10.3	↑
13:	9.9	→
14:	9.6	↘
15:	10.4	↘
16:	10.5x	↙
17:	9.8	↖
18:	10.1	↑
19:	9.9	↗
20:	10.5x	→
<b>Serie</b>		<b>96.0</b>
<b>Total</b>		<b>193.0</b>

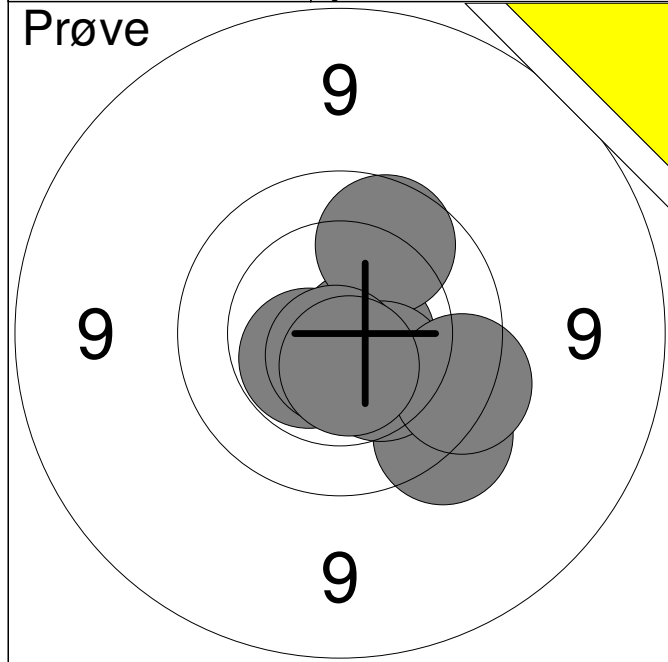

1:	10.5x	↙
2:	10.7x	→
3:	9.9	↑
4:	9.6	↘
5:	10.3	↘
6:	9.7	→
7:	10.7x	↘
8:	10.6x	↘
<b>Serie</b>		<b>77.0</b>
<b>Total</b>		<b>0.0</b>

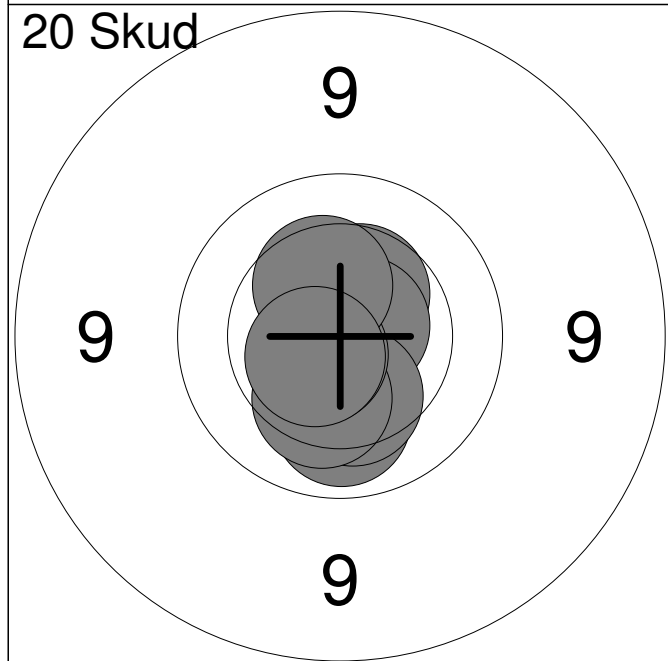

1:	10.8x	→
2:	10.6x	↘
3:	10.4	↑
4:	10.7x	→
5:	10.1	↘
6:	10.3	↘
7:	10.3	↘
8:	10.6x	↙
9:	10.4	↑
10:	10.6x	↙
<b>Serie</b>		<b>100.0</b>
<b>Total</b>		<b>100.0</b>

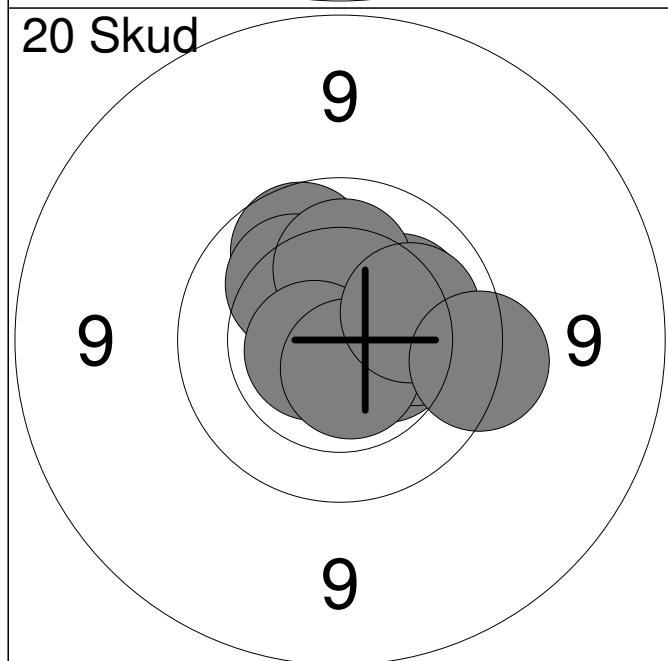

11:	10.5	→
12:	10.2	→
13:	10.1	→
14:	9.9	↑
15:	10.2	↗
16:	10.2	↑
17:	10.6x	↙
18:	10.6x	↘
19:	10.1	→
20:	9.7	→
<b>Serie</b>		<b>98.0</b>
<b>Total</b>		<b>198.0</b>

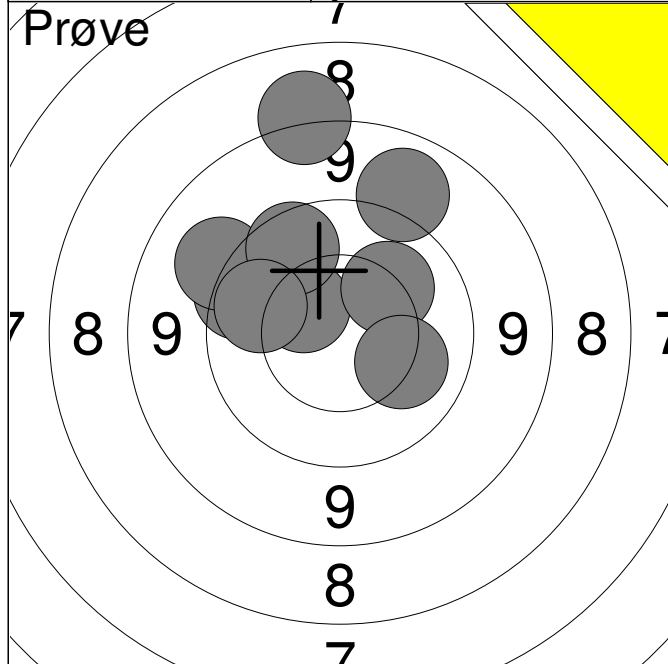

1:	8.3	↑
2:	10.4	↗
3:	10.2	→
4:	9.7	↖
5:	9.1	↑
6:	9.3	↗
8:	9.8	↗
9:	10.0	↗
10:	10.2	↘
<b>Serie</b>		<b>84.0</b>
<b>Total</b>		<b>0.0</b>

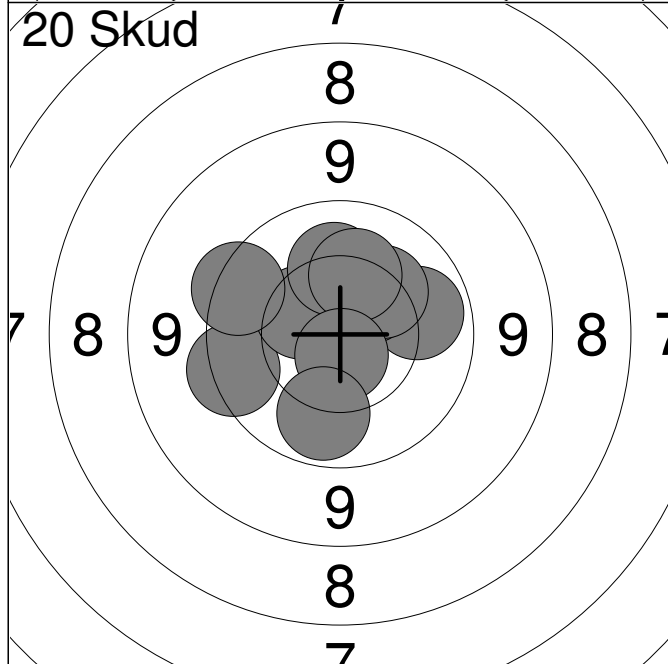

1:	9.6	←
2:	10.4	↖
3:	9.6	↖
4:	10.0	→
5:	10.4	↗
6:	10.2	↑
7:	10.3	↗
8:	10.3	↑
9:	10.7x	↓
10:	10.0	↓
<b>Serie</b>		<b>98.0</b>
<b>Total</b>		<b>98.0</b>

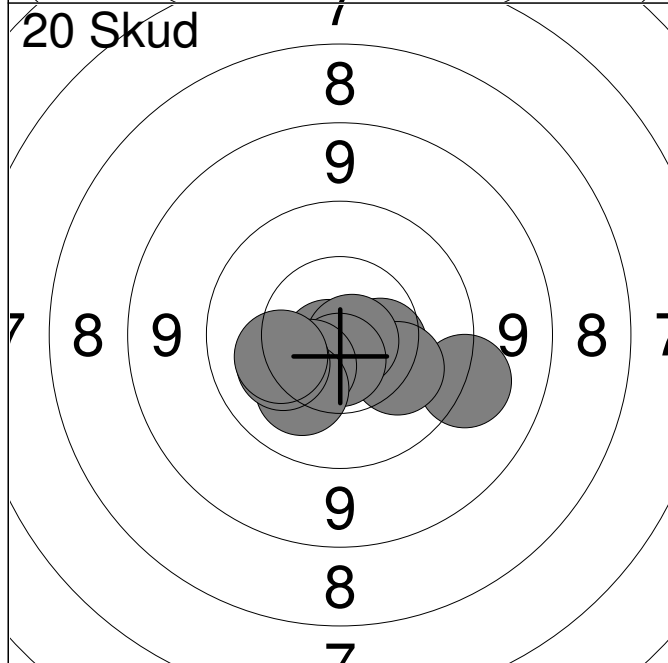

11:	10.8x	↙
12:	9.4	→
13:	10.5	→
14:	10.2	↘
15:	10.8x	↘
16:	10.7x	↓
17:	10.5	↙
18:	10.2	↙
19:	10.2	↙
20:	10.2	↙
<b>Serie</b>		<b>99.0</b>
<b>Total</b>		<b>197.0</b>

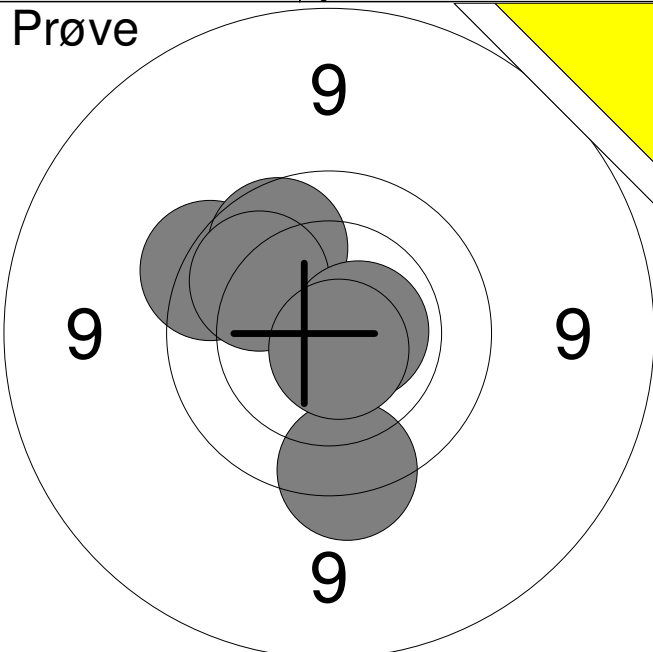
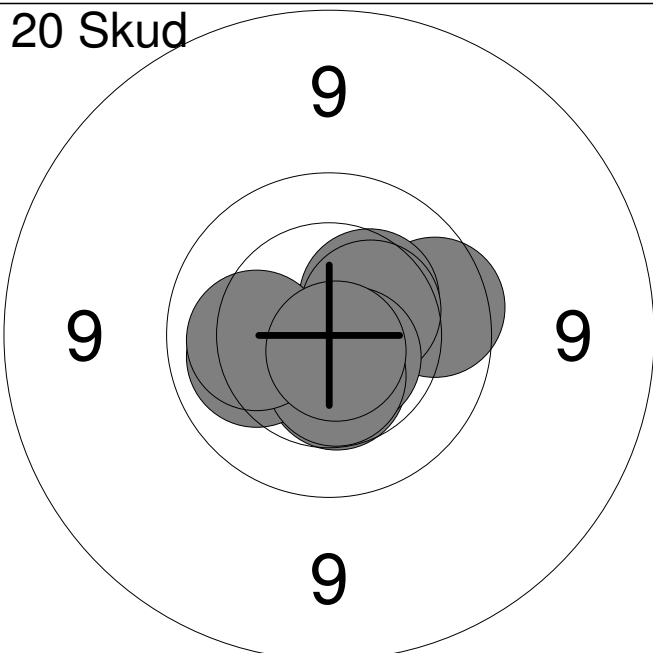
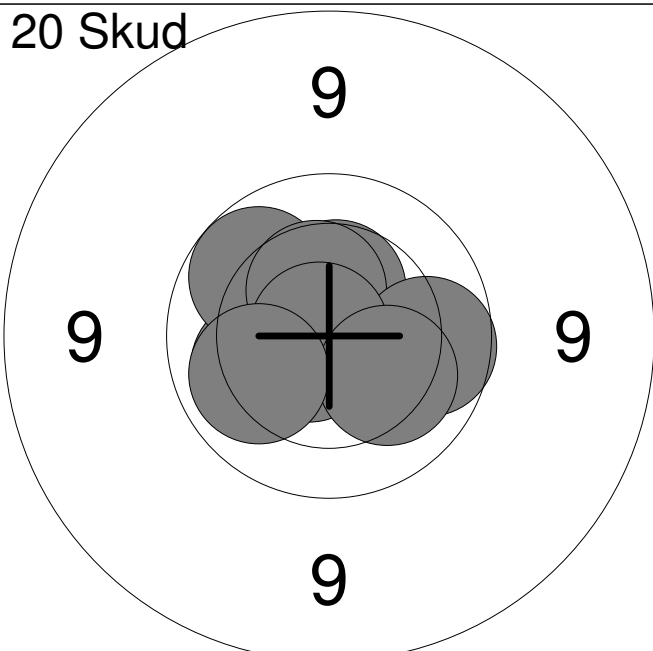
Hold <b>24</b>	Skive <b>6</b>	<b>Lars Jakobsen</b>		
15m	Vilsted Skf.		MÅ1	
11.02.2015	Jyllandsstævne 2015	Aalborg Skyttekreds		
Prøve		1:	9.7	↓
		2:	9.7	↗
		3:	9.9	↗
		4:	10.0	↗
		5:	10.6x	→
		6:	10.8x	↓
		<b>Serie</b>	<b>57.0</b>	
		<b>Total</b>	<b>0.0</b>	
20 Skud		1:	9.8	→
		2:	10.8x	↓
		3:	10.4	↗
		4:	10.5	↓
		5:	10.1	←
		6:	10.4	↗
		7:	10.6x	↓
		8:	10.5x	↓
		9:	10.2	←
		10:	10.8x	↓
		<b>Serie</b>	<b>99.0</b>	
		<b>Total</b>	<b>99.0</b>	
20 Skud		11:	10.6x	←
		12:	10.1	←
		13:	10.0	↗
		14:	10.7x	←
		15:	10.4	↗
		16:	10.4	↗
		17:	9.9	→
		18:	10.8x	←
		19:	10.2	↓
		20:	10.1	←
		<b>Serie</b>	<b>99.0</b>	
		<b>Total</b>	<b>198.0</b>	

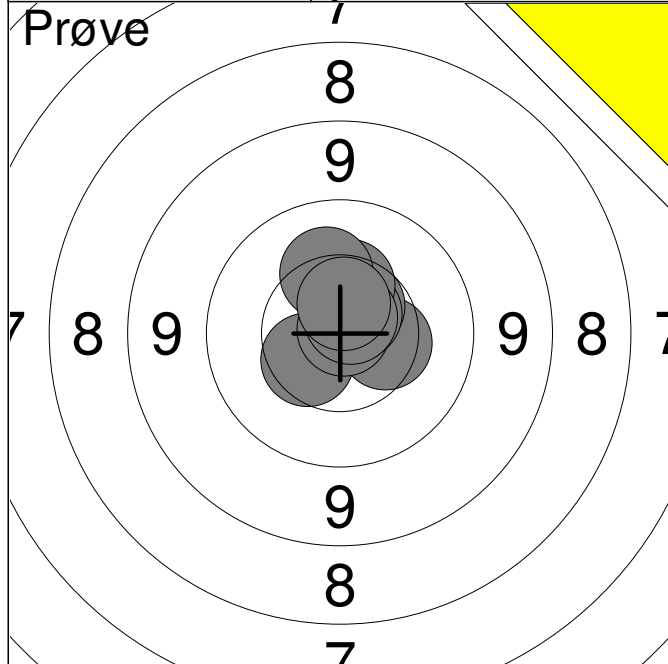

1:	10.5	↙
2:	10.4	→
3:	10.9x	↗
4:	10.6	↗
5:	10.7x	↗
6:	10.4	↑
7:	10.7x	↗
8:	10.2	↑
9:	10.6x	↑
<b>Serie</b>		<b>90.0</b>
<b>Total</b>		<b>0.0</b>

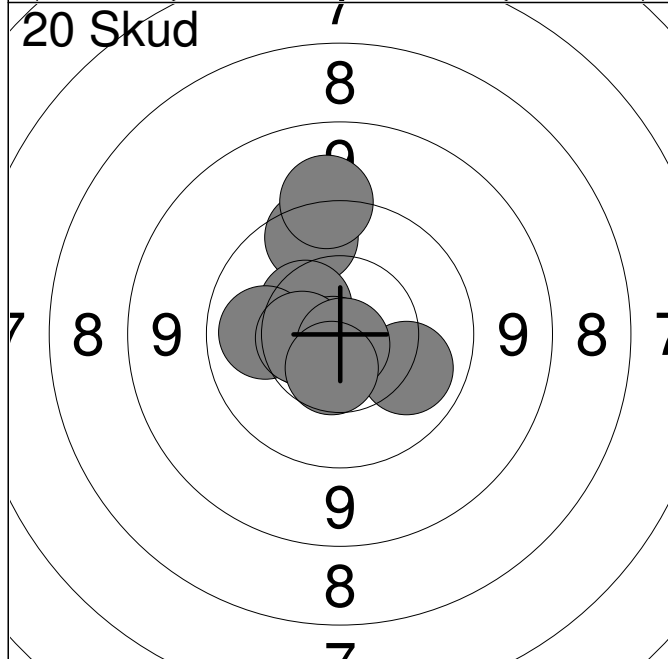

1:	10.1	→
2:	9.8	↑
3:	9.4	↑
4:	10.4	↗
5:	10.6	←
6:	10.1	←
7:	10.8x	↙
8:	10.5	←
9:	10.8x	↓
10:	10.5	↓
<b>Serie</b>		<b>98.0</b>
<b>Total</b>		<b>98.0</b>

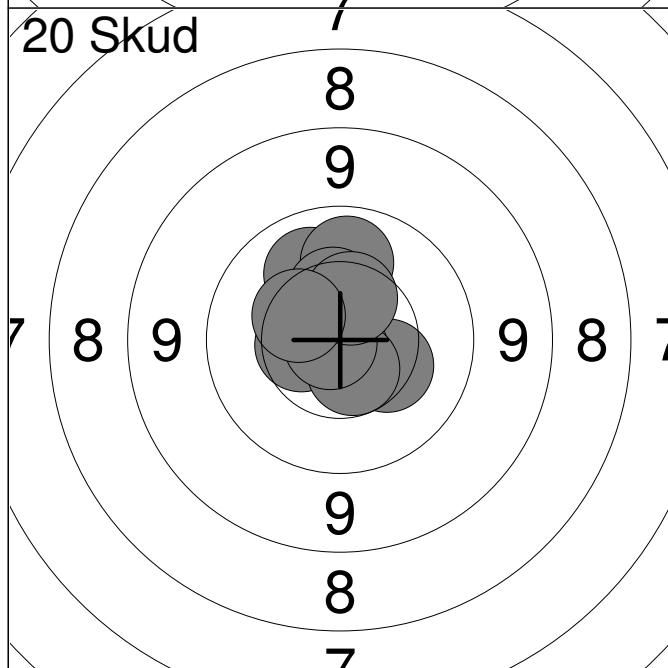

11:	10.5	←
12:	10.3	→
13:	10.1	↗
14:	10.1	↑
15:	10.4	↑
16:	10.8x	↓
17:	10.6	↓
18:	10.8x	←
19:	10.5	↑
20:	10.4	↙
<b>Serie</b>		<b>100.0</b>
<b>Total</b>		<b>198.0</b>

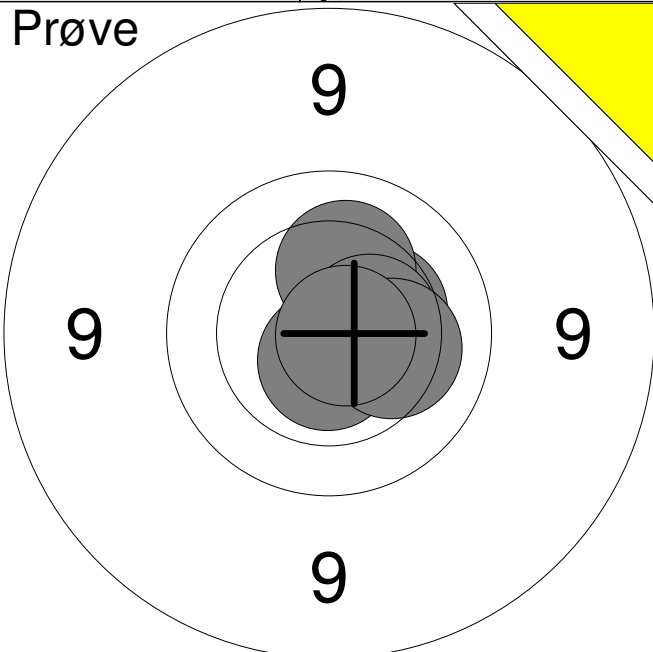
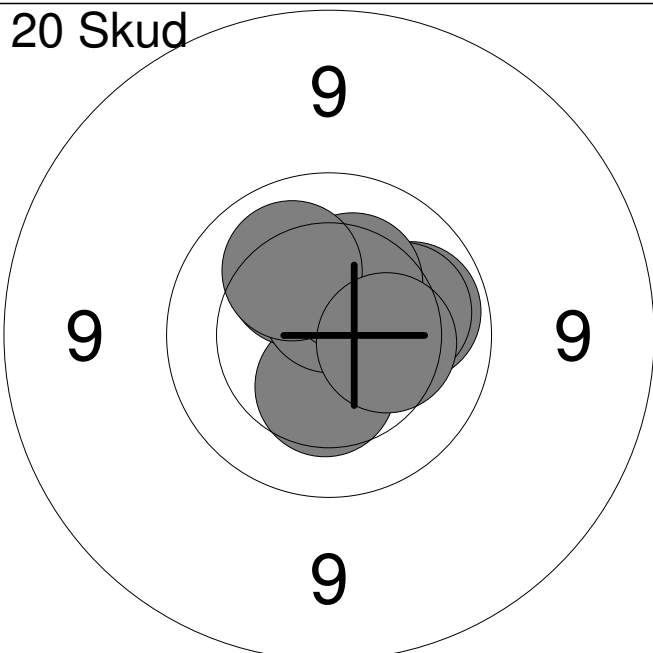
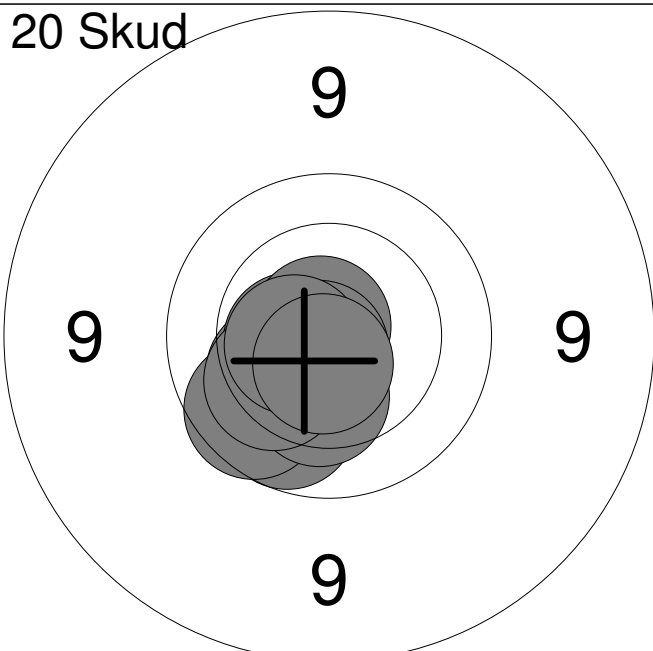
Hold	Skive	Victor B. Nielsen	
24	9	Aalborg Skyttekreds	MJ1
15m			
11.02.2015	Jyllandsstævne 2015	Aalborg Skyttekreds	
Prøve		1: 10.4	→
		2: 10.7x	↓
		3: 10.2	↑
		4: 10.5x	→
		5: 10.2	→
		6: 10.8x	→
		<b>Serie</b>	<b>60.0</b>
		<b>Total</b>	<b>0.0</b>
20 Skud		1: 10.3	→
		2: 10.4	↓
		3: 10.3	→
		4: 10.0	→
		5: 10.2	↑
		6: 10.1	→
		7: 10.6x	↑
		8: 10.3	↑
		9: 10.1	↑
		10: 10.3	→
		<b>Serie</b>	<b>100.0</b>
		<b>Total</b>	<b>100.0</b>
20 Skud		11: 9.9	↓
		12: 9.9	↙
		13: 10.3	↓
		14: 10.3	↙
		15: 10.6x	↙
		16: 10.8x	↗
		17: 10.2	↙
		18: 10.8x	↙
		19: 10.6x	↙
		20: 10.6x	↓
		<b>Serie</b>	<b>98.0</b>
		<b>Total</b>	<b>198.0</b>



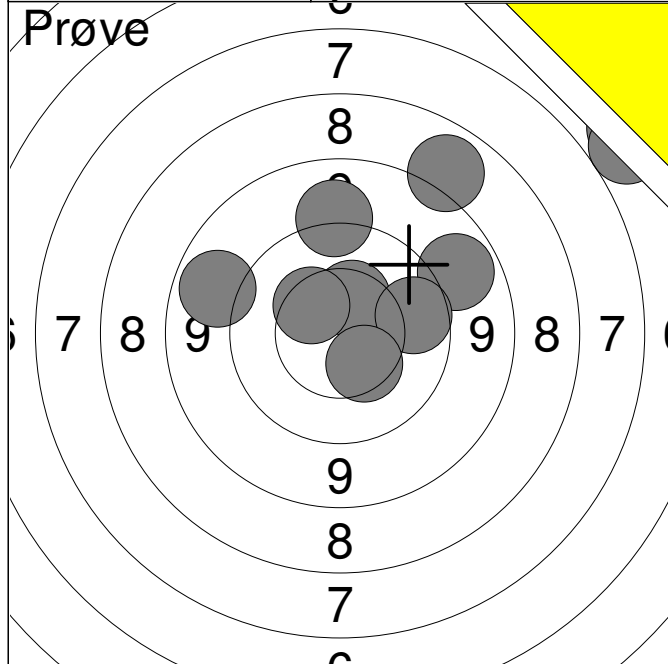

1:	5.6	↗
2:	9.0	→
3:	5.8	↗
4:	8.1	↗
5:	10.4	↑
6:	9.9	→
7:	9.0	↖
8:	9.3	↑
9:	10.4	↗
10:	10.4	↓
<b>Serie</b>		<b>84.0</b>
<b>Total</b>		<b>0.0</b>

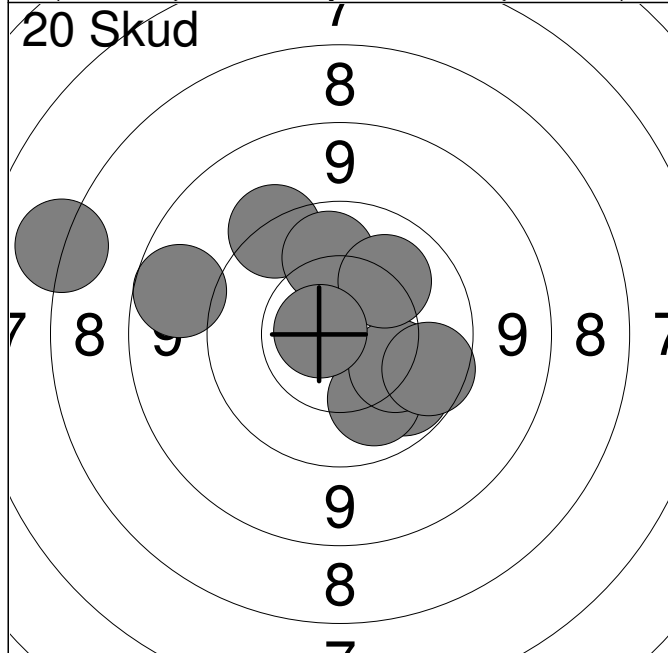

1:	10.0	↓
2:	7.3	↖
3:	9.5	↗
4:	10.0	↑
5:	8.9	↖
6:	10.1	↓
7:	10.2	↓
8:	9.8	→
9:	10.1	↗
10:	10.7x	↖
<b>Serie</b>		<b>93.0</b>
<b>Total</b>		<b>93.0</b>

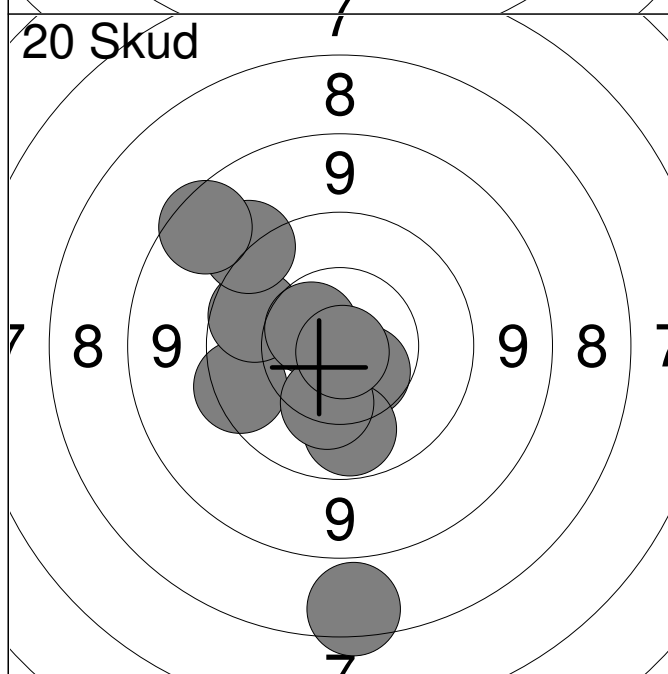

11:	10.5	↓
12:	9.7	↖
13:	9.9	↖
14:	10.6	↗
15:	10.0	↓
16:	10.3	↘
17:	10.9x	↘
18:	9.3	↗
19:	8.8	↗
20:	7.7	↓
<b>Serie</b>		<b>92.0</b>
<b>Total</b>		<b>185.0</b>

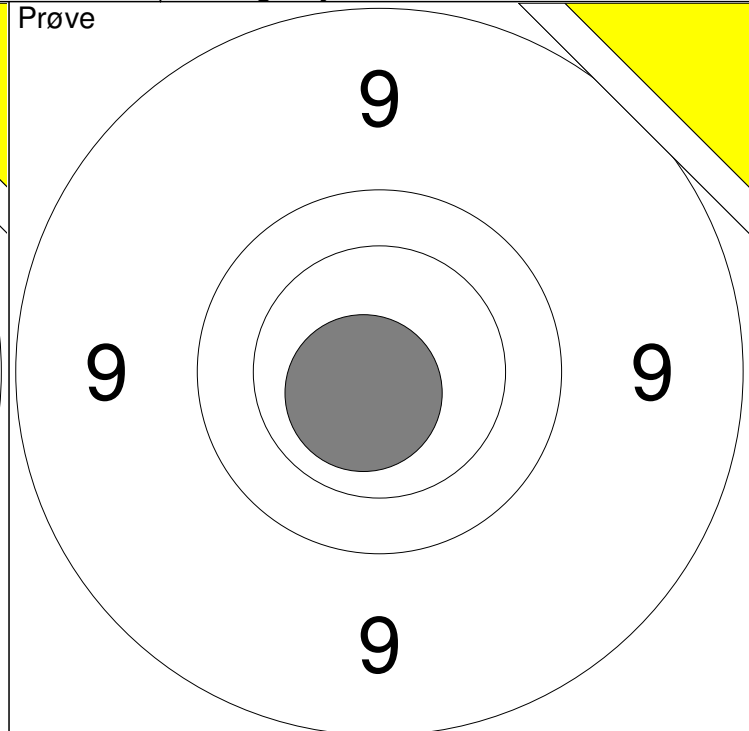
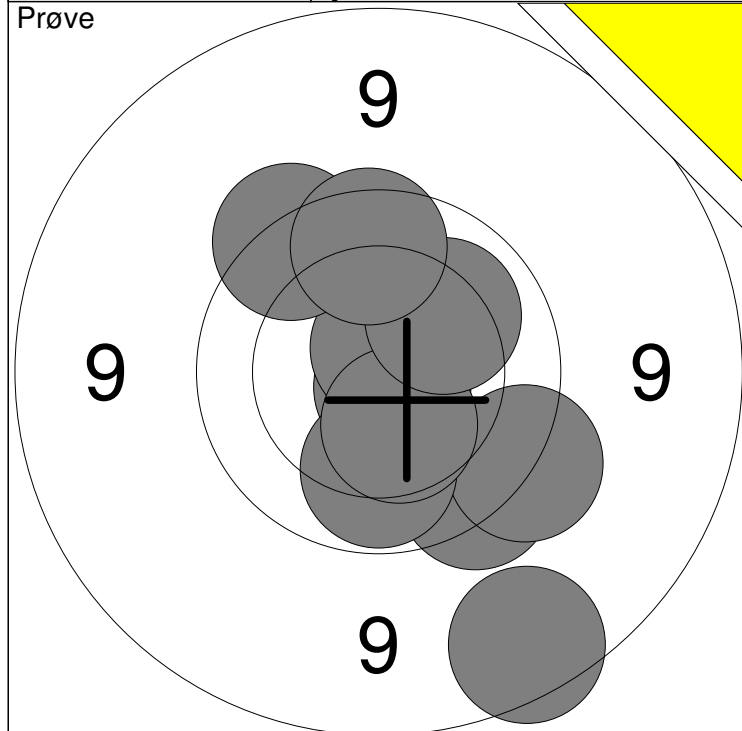

1: 8.9 ↘	6: 10.0 ↓	Serie	94
2: 9.7 ↘	7: 10.4 ↓		
3: 9.6 ↘	8: 10.1 ↗	Total	0
4: 10.8x ↘	9: 9.7 ↗		
5: 10.7x ↗	10: 9.8 ↑		

11: 10.7x ↘		Serie	10
		Total	0

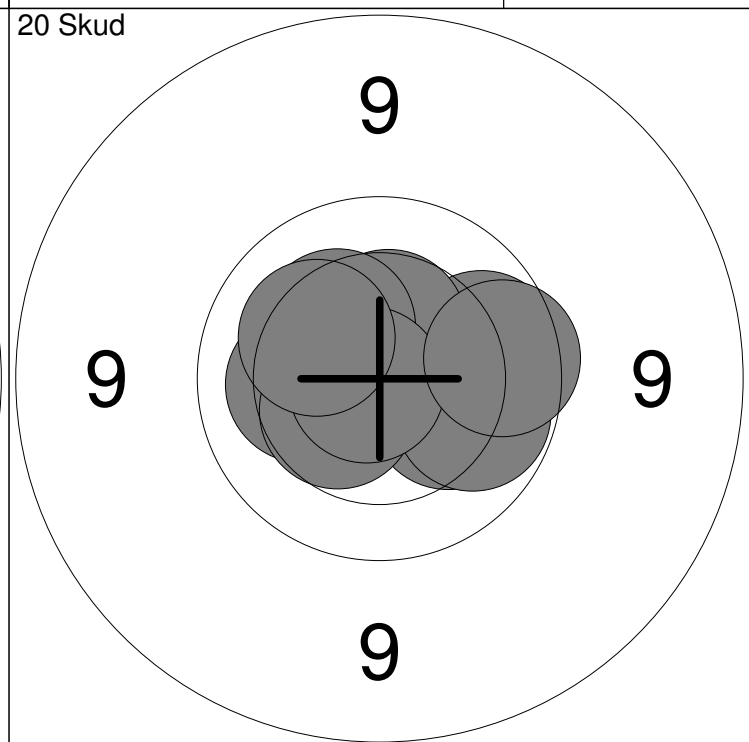
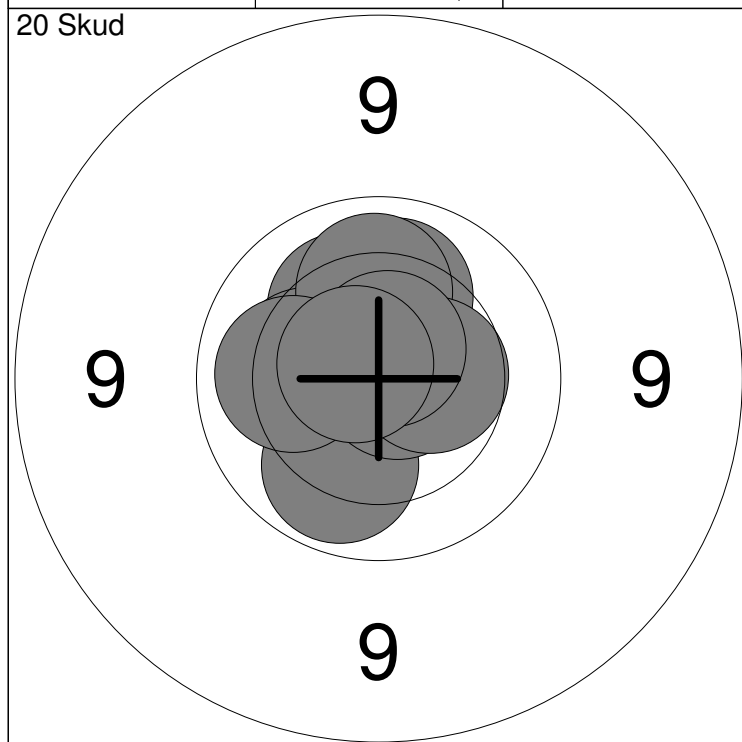

1: 10.0 ↘	6: 10.1 ↑	Serie	100
2: 10.1 ↑	7: 10.5 →		
3: 10.2 ↗	8: 10.7x ↑	Total	100
4: 10.3 ←	9: 10.1 ←		
5: 10.8x →	10: 10.7x ↖		

11: 10.2 →	16: 10.2 ←	Serie	98
12: 9.9 →	17: 10.4 ↘		
13: 10.0 →	18: 10.8x ←	Total	198
14: 10.5 ↑	19: 9.8 →		
15: 10.3 ↖	20: 10.2 ↖		

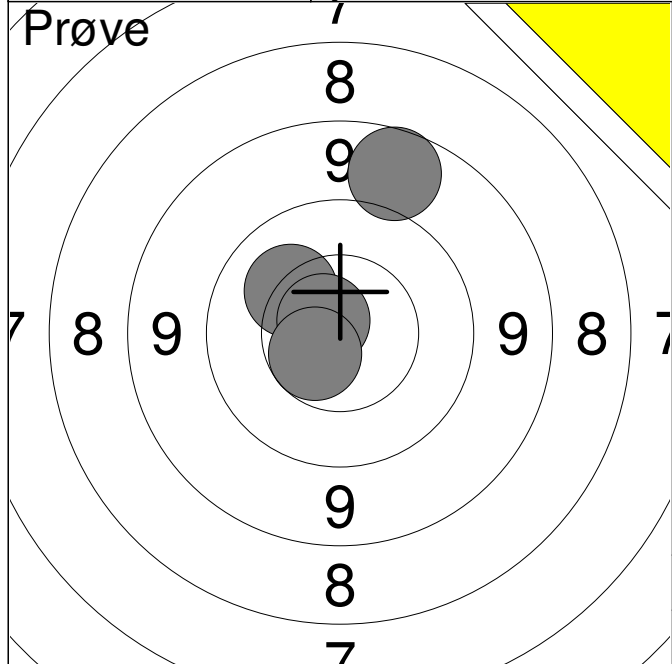

1:	8.9	↗
2:	10.2	↗
3:	10.7x	↗
4:	10.6	↘
<b>Serie</b>		<b>38.0</b>
<b>Total</b>		<b>0.0</b>

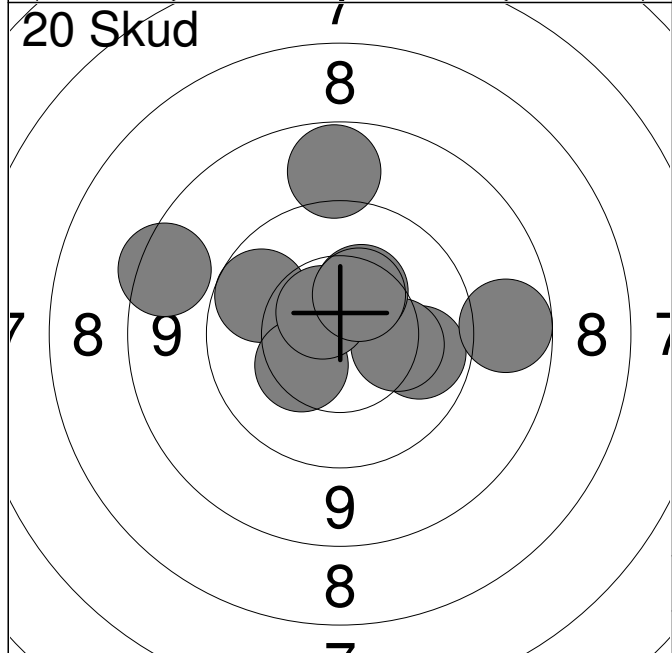

1:	9.9	↗
2:	10.0	→
3:	10.3	→
4:	8.7	↖
5:	8.9	→
6:	10.4	↙
7:	10.6x	↗
8:	10.4	↗
9:	10.4	↗
10:	9.0	↑
<b>Serie</b>		<b>94.0</b>
<b>Total</b>		<b>94.0</b>

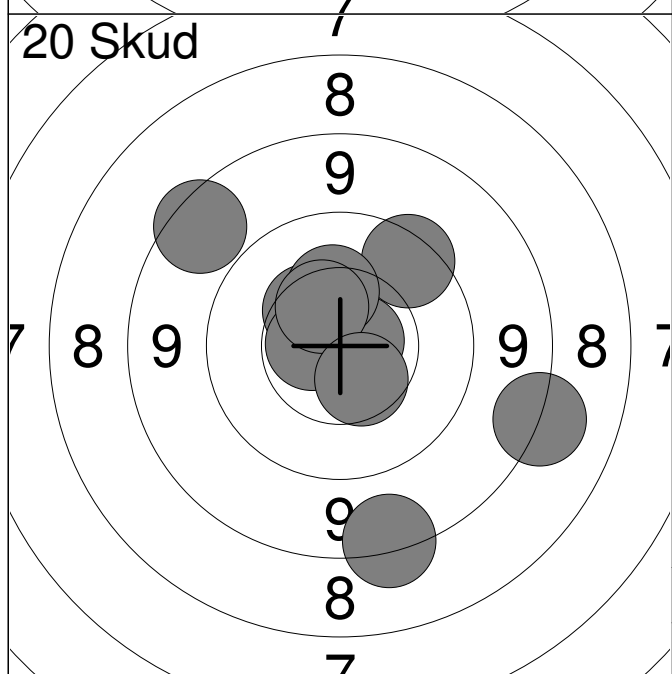

11:	10.7x	→
12:	8.3	→
13:	9.7	↗
14:	8.7	↗
15:	8.5	↘
16:	10.4	↗
17:	10.6x	←
18:	10.3	↗
19:	10.4	↗
20:	10.5	↘
<b>Serie</b>		<b>93.0</b>
<b>Total</b>		<b>187.0</b>

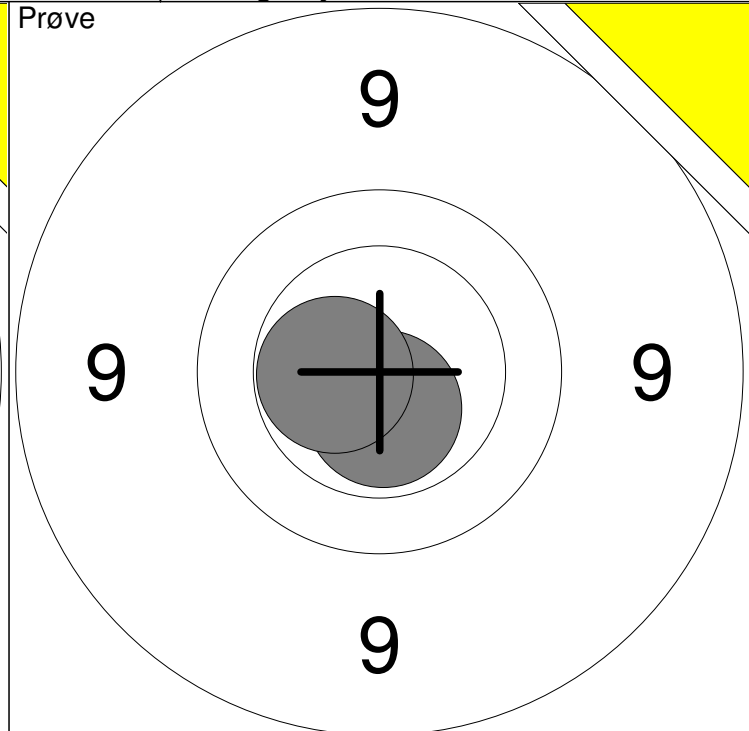
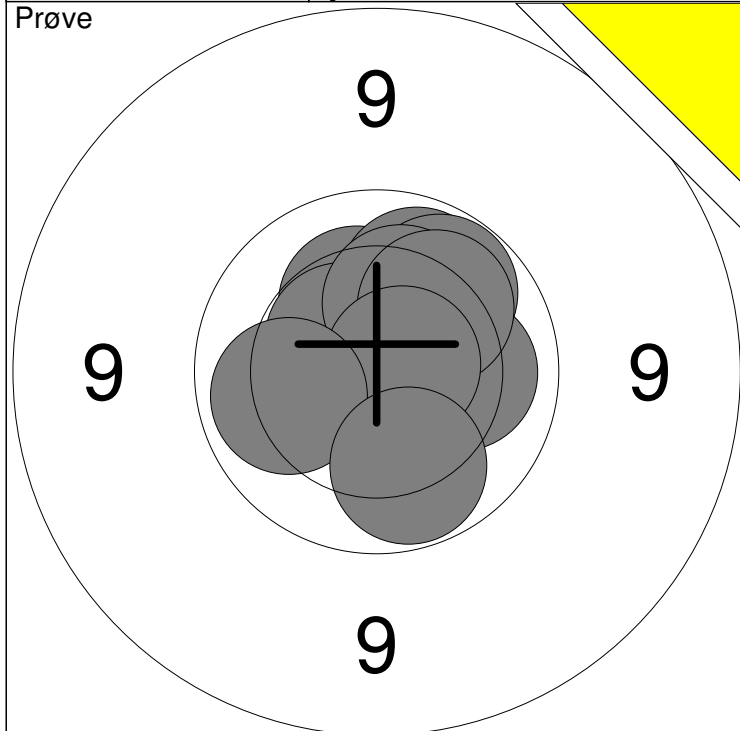

1: 10.3 ↗	6: 10.2 ↗	Serie	100
2: 10.2 →	7: 10.1 ↗		
3: 10.0 ↗	8: 10.7x →	Total	0
4: 10.0 ↗	9: 10.1 ←		
5: 10.5x ↖	10: 10.0 ↓		

11: 10.6x ↓	Serie	20
12: 10.5x ←		
Total		0

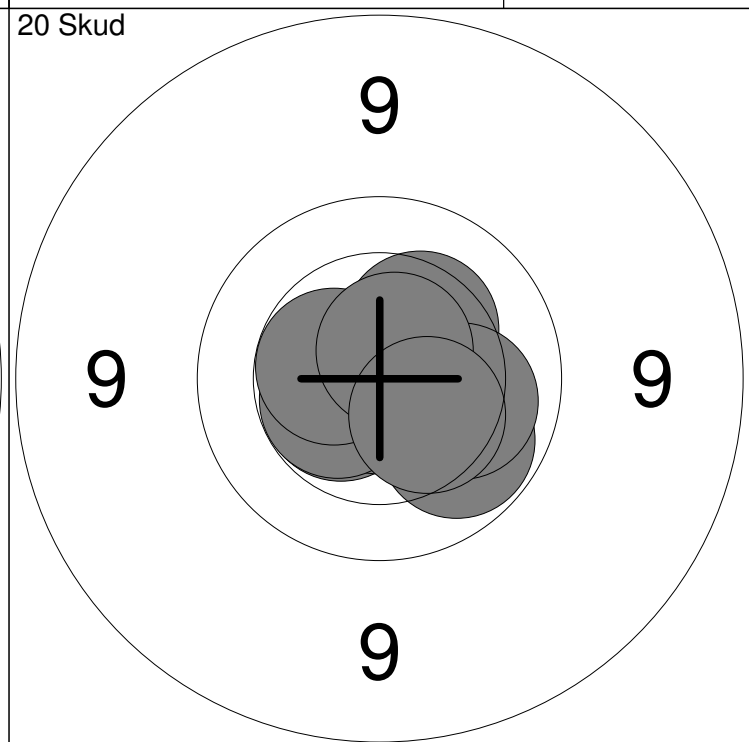
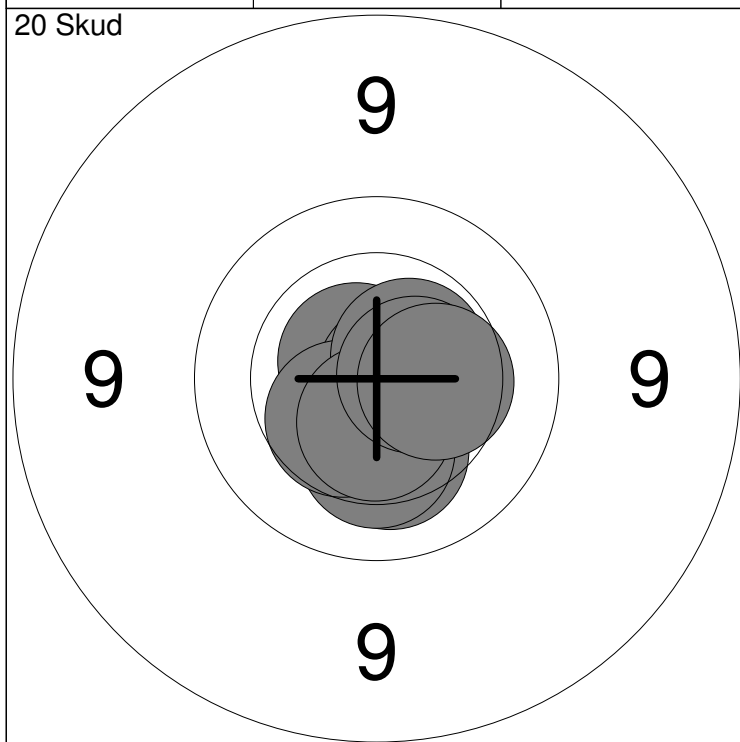

1: 10.7x ↗	6: 10.4 ↘	Serie	100
2: 10.2 ↓	7: 10.6x ↗		
3: 10.8x →	8: 10.5x ↓	Total	100
4: 10.7x ↓	9: 10.6x →		
5: 10.3 ↓	10: 10.4 →		

11: 10.5x ↖	16: 10.1 →	Serie	100
12: 10.6x ↖	17: 10.5x ↖		
13: 10.3 ↗	18: 10.5x ↖	Total	200
14: 10.0 ↘	19: 10.6x ↗		
15: 10.8x ↓	20: 10.4 ↘		

Hold <b>25</b>	Skive <b>4</b>	<b>Jørgen Sloth Borregaard</b>	
-------------------	-------------------	--------------------------------	--

15m	Mou & Omegns Skf.	ÅK2
-----	-------------------	-----

11.02.2015	Jyllandsstævne 2015	Aalborg Skyttekreds
------------	---------------------	---------------------

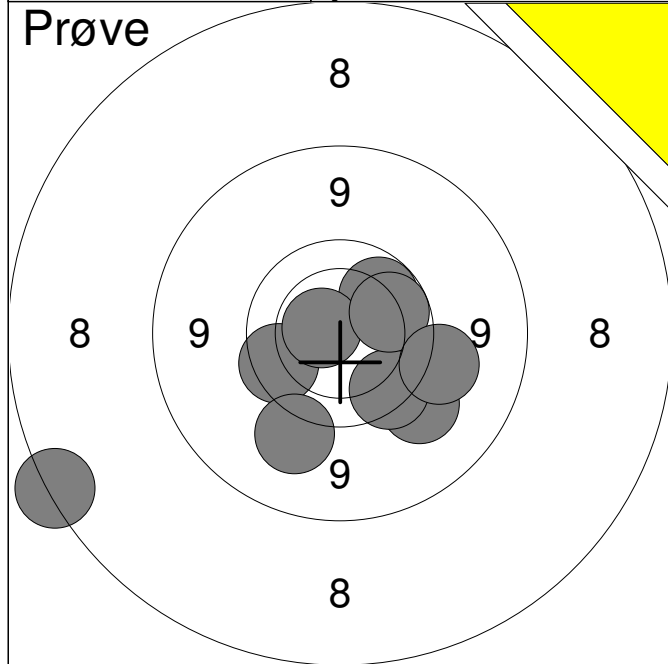

1:	7.7	↙
2:	10.0	↗
3:	9.8	↙
4:	9.4	↘
5:	9.7	↘
6:	9.3	↘
7:	10.6x	↖
8:	9.9	↗
9:	9.4	↘

<b>Serie</b>	<b>81.0</b>
<b>Total</b>	<b>0.0</b>

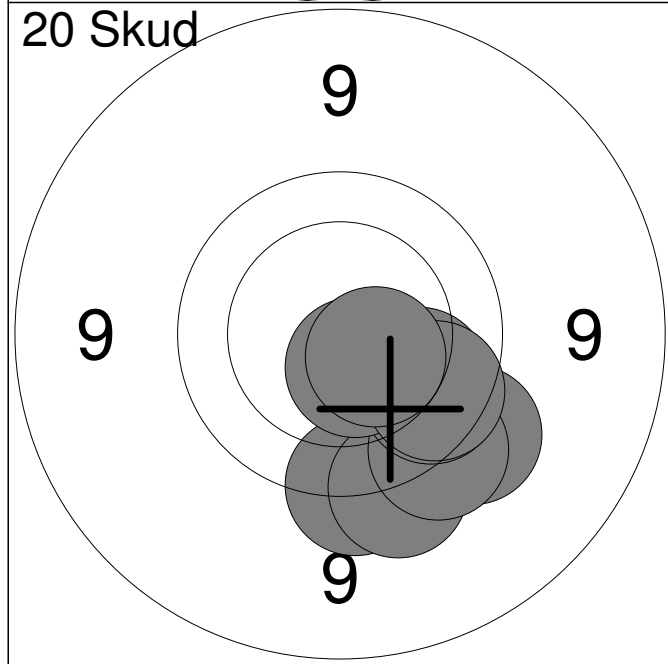

1:	9.6	↘
2:	9.5	↘
3:	9.9	↘
4:	9.5	↘
5:	10.0	↘
6:	9.6	↘
7:	9.9	↘
8:	10.6x	↘
9:	9.8	↘
10:	10.5x	↘

<b>Serie</b>	<b>93.0</b>
<b>Total</b>	<b>93.0</b>

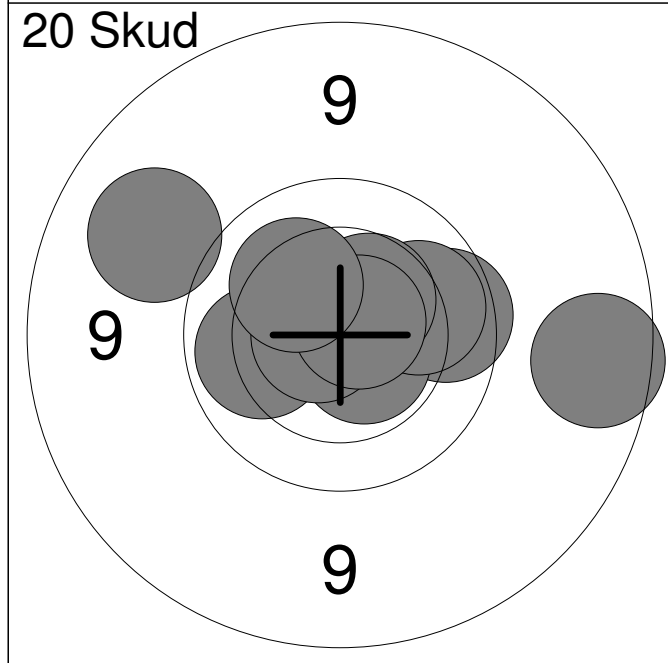

11:	9.8	→
12:	10.6x	↘
13:	10.1	↖
14:	10.7x	↖
15:	9.2	↗
16:	8.9	→
17:	10.0	→
18:	10.4	↗
19:	10.7x	↗
20:	10.2	↗

<b>Serie</b>	<b>96.0</b>
<b>Total</b>	<b>189.0</b>

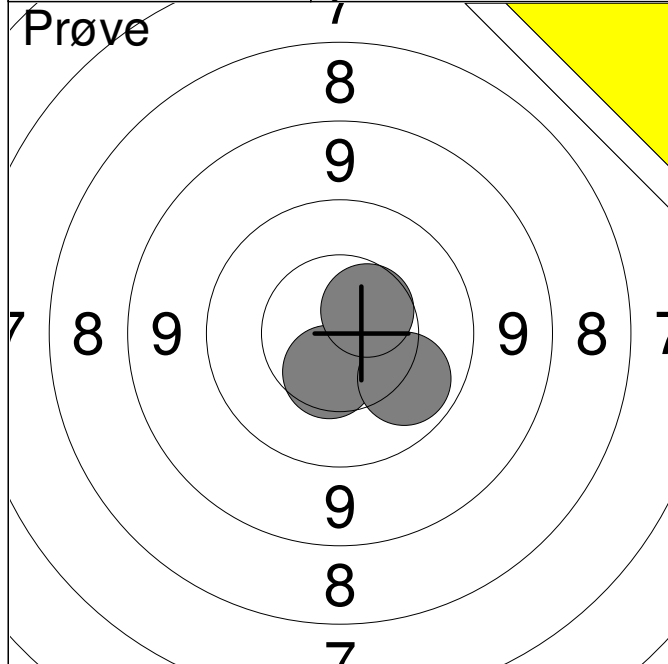

	1:	10.5	↓
	2:	10.0	→
	3:	10.5	↗
<b>Serie</b>			<b>30.0</b>
<b>Total</b>			<b>0.0</b>

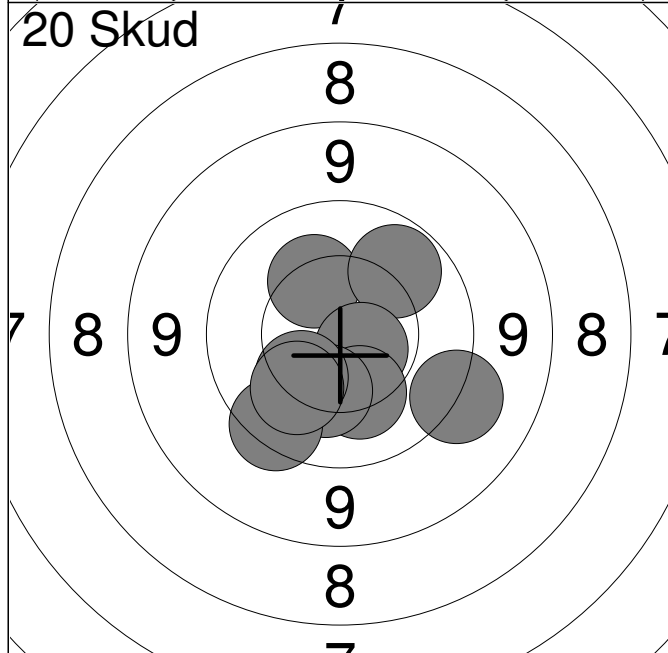

	1:	10.3	↗
	2:	10.0	↗
	3:	10.3	↓
	4:	10.7x	↓
	5:	10.2	↓
	6:	10.3	↓
	7:	10.3	↙
	8:	9.4	→
	9:	9.6	↙
	10:	10.2	↙
<b>Serie</b>			<b>98.0</b>
<b>Total</b>			<b>98.0</b>

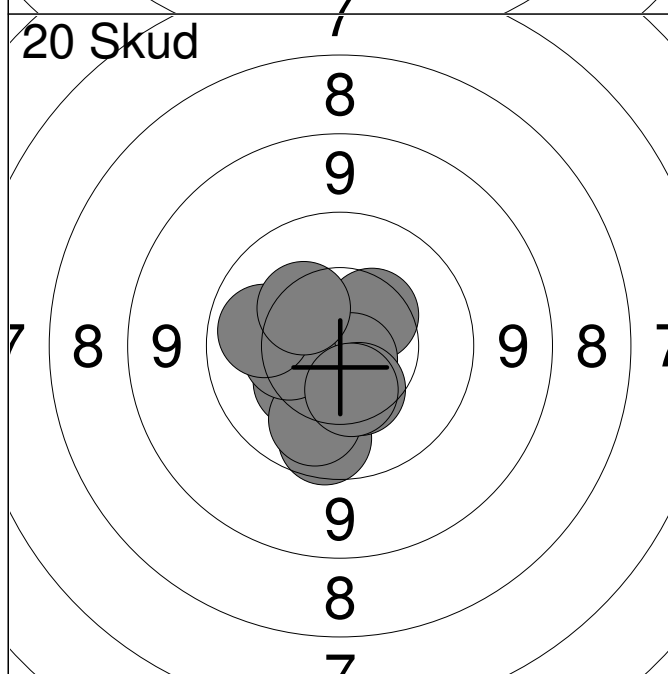

	11:	10.4	↗
	12:	10.3	↙
	13:	9.9	↓
	14:	10.1	↙
	15:	10.8x	↓
	16:	10.4	↙
	17:	10.4	↙
	18:	10.1	↙
	19:	10.4	↓
	20:	10.3	↗
<b>Serie</b>			<b>99.0</b>
<b>Total</b>			<b>197.0</b>

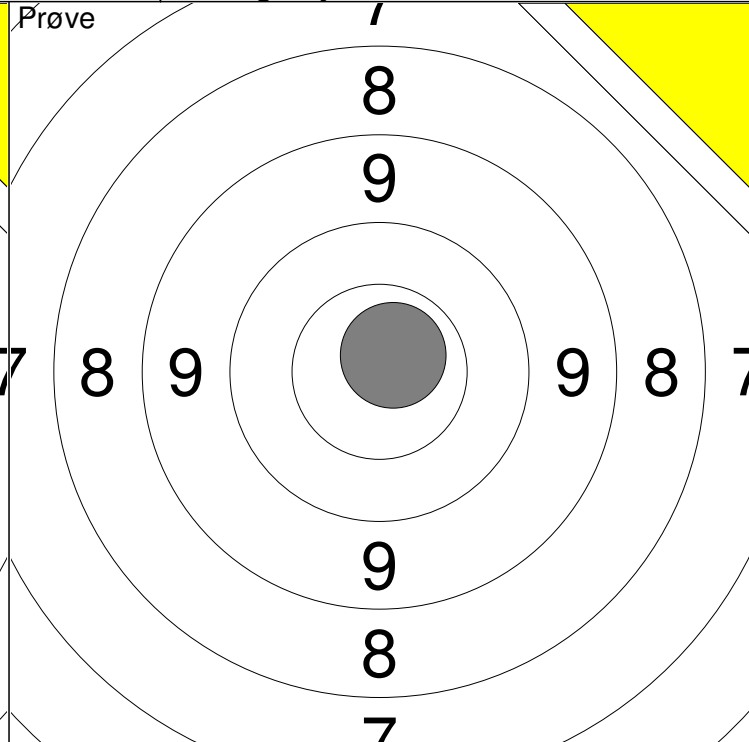
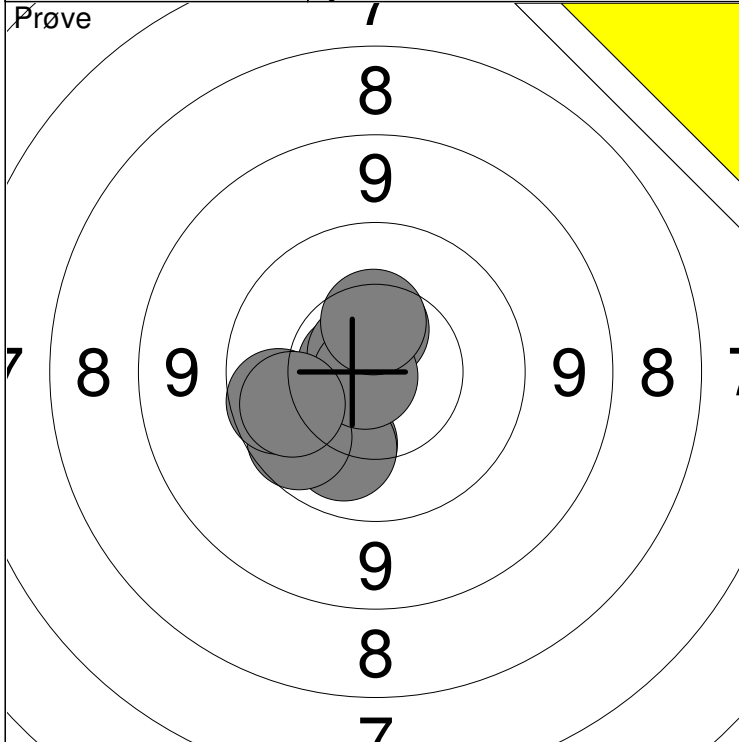

1: 10.1 ↘	6: 9.9 ←			11: 10.7x ↗			
2: 10.1 ↘	7: 10.5 ↑	Serie	98			Serie	10
3: 10.7x ←	8: 10.8x ←						
4: 9.9 ↙	9: 10.0 ←	Total	0			Total	0
5: 10.7x ↖	10: 10.4 ↑						

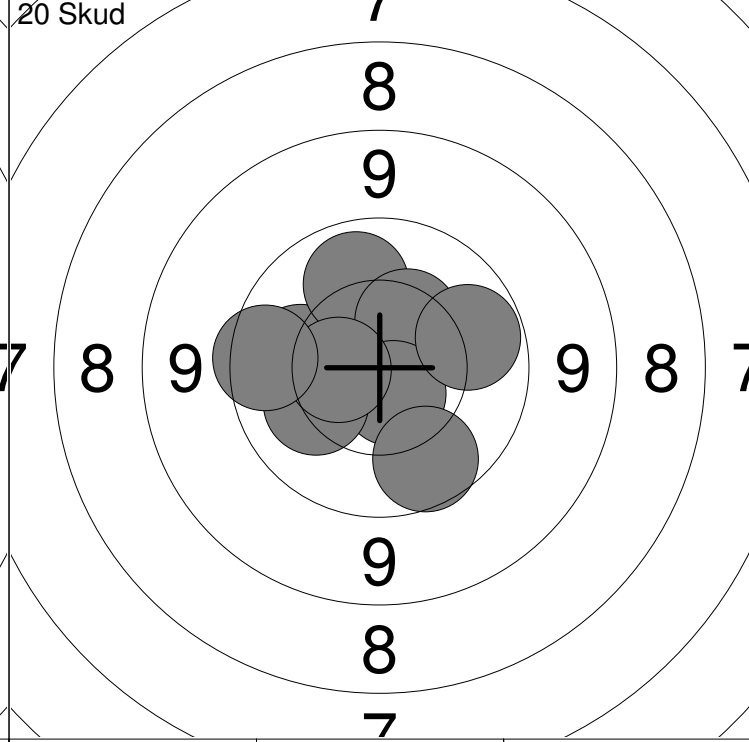
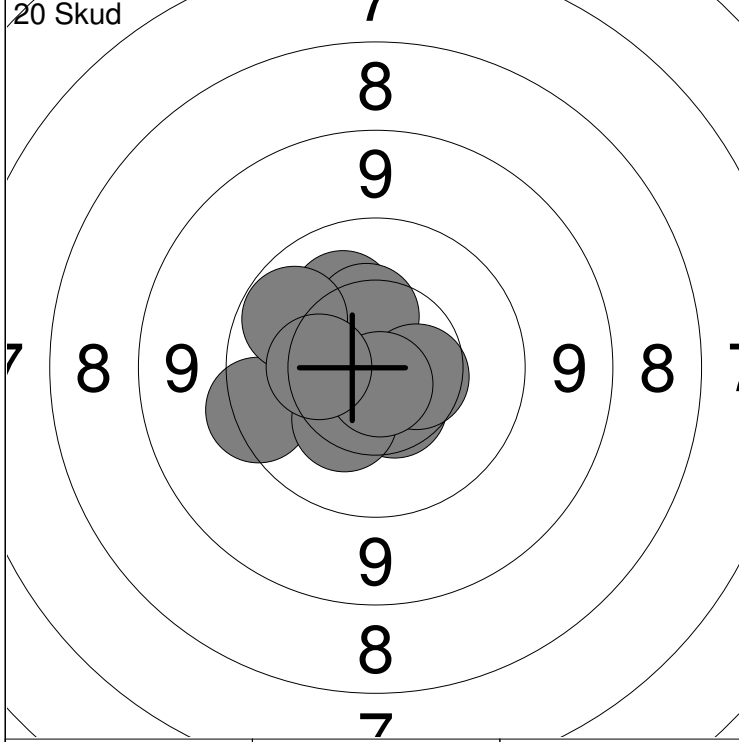

1: 10.5 ↘	6: 10.0 ↗			11: 10.1 ←	16: 10.2 ←		
2: 10.3 ↗	7: 10.3 ↘	Serie	99	12: 10.8x ↘	17: 9.9 ↘	Serie	98
3: 10.2 ↗	8: 10.5 →			13: 10.1 ↑	18: 10.0 →		
4: 10.4 ↑	9: 10.8x ↘	Total	99	14: 10.4 ↗	19: 10.5 ←	Total	197
5: 9.6 ←	10: 10.4 ←			15: 10.7x ↘	20: 9.7 ←		

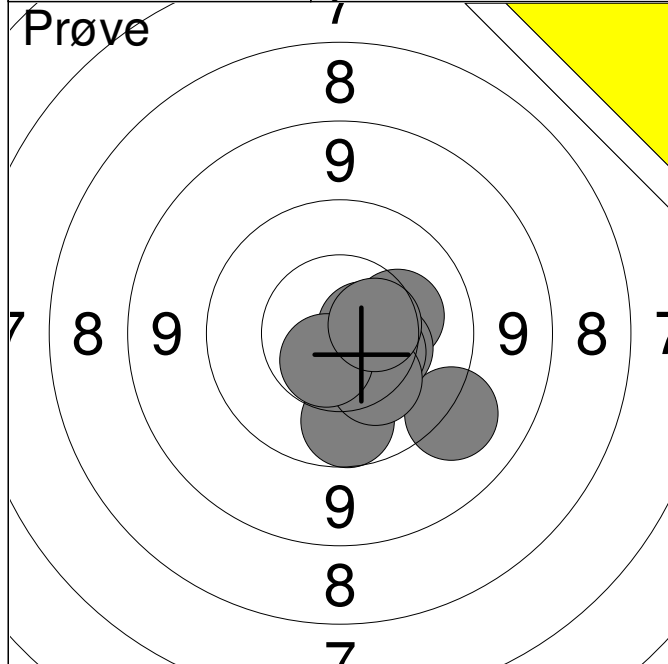

1:	10.2	→
2:	10.7x	→
3:	9.3	↘
4:	10.7x	→
5:	9.9	↘
6:	10.4	→
7:	10.4	↘
8:	10.3	↘
9:	10.6x	↘
10:	10.5	→
<b>Serie</b>		<b>98.0</b>
<b>Total</b>		<b>0.0</b>

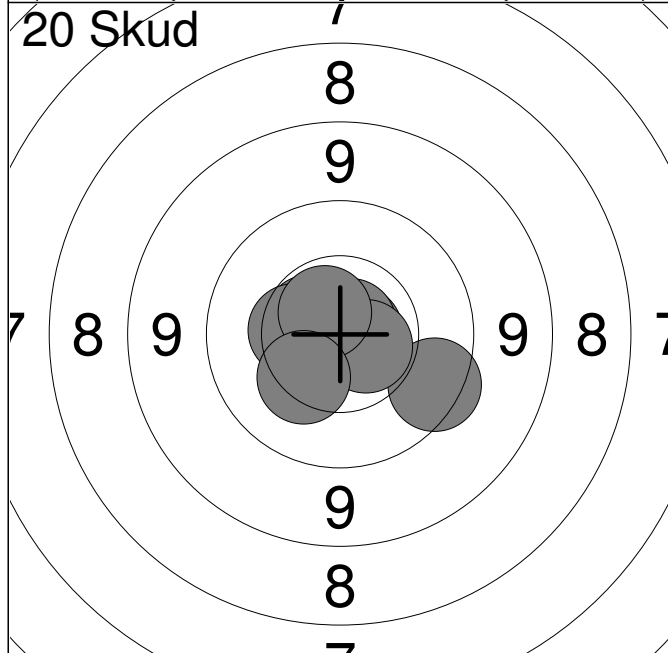

1:	10.5	↙
2:	10.5	↙
3:	10.6	↗
4:	9.7	↘
5:	10.8x	→
6:	10.8x	↗
7:	10.4	↙
8:	10.6x	↘
9:	10.6x	↗
10:	10.3	↙
<b>Serie</b>		<b>99.0</b>
<b>Total</b>		<b>99.0</b>

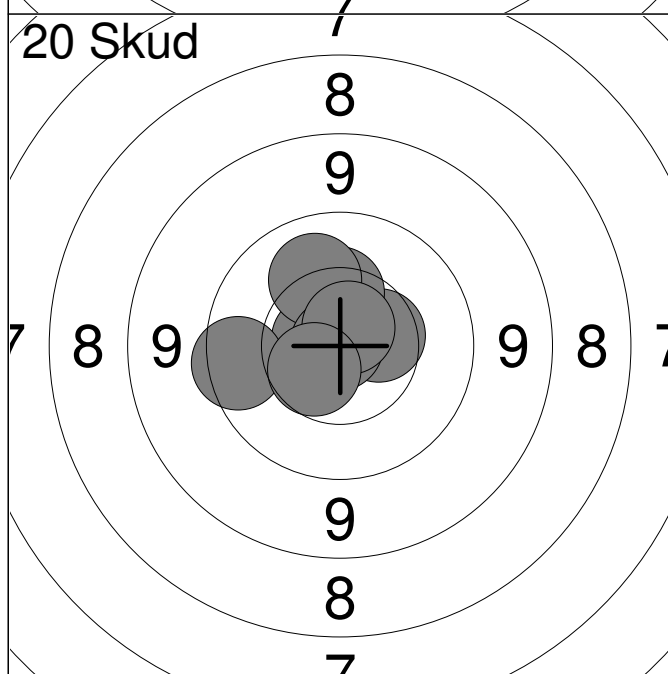

11:	10.7x	↗
12:	10.5	↑
13:	10.7x	↙
14:	10.5	→
15:	10.3	↑
16:	10.1	↗
17:	10.9x	↙
18:	9.7	↙
19:	10.7x	↗
20:	10.5	↙
<b>Serie</b>		<b>99.0</b>
<b>Total</b>		<b>198.0</b>



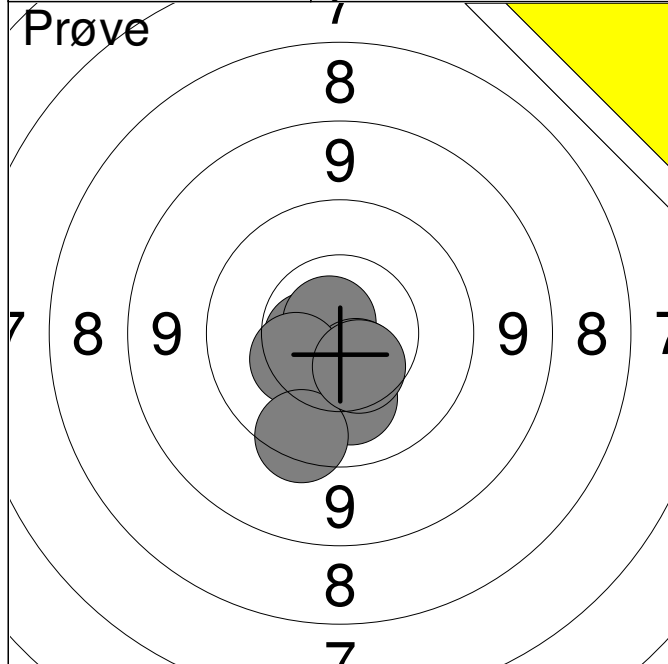

1:	10.2	↓
2:	10.6x	←
3:	10.8x	↗
4:	10.5	↓
5:	10.4	←
6:	9.7	↓
7:	10.5	↓
<b>Serie</b>		<b>69.0</b>
<b>Total</b>		<b>0.0</b>

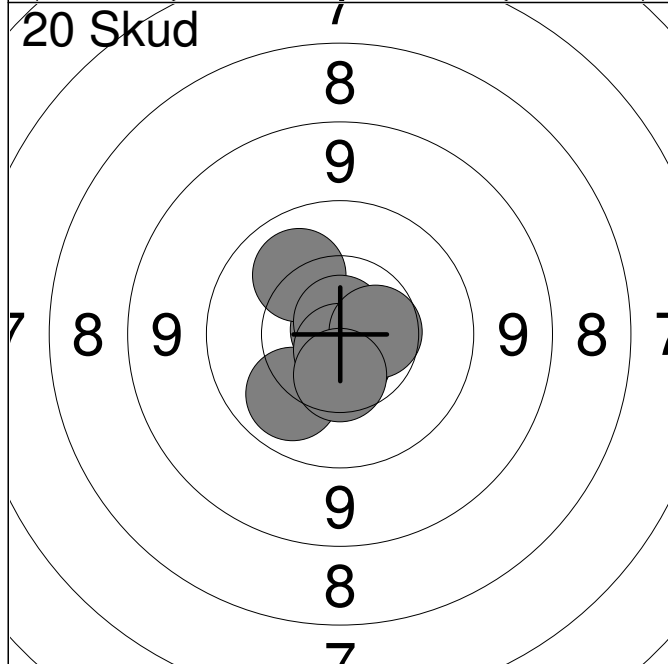

1:	10.9x	↗
2:	10.6x	↓
3:	10.1	↗
4:	10.1	↙
5:	10.8x	→
6:	10.9x	↘
7:	10.8x	↑
8:	10.8x	↓
9:	10.5	→
10:	10.5	↓
<b>Serie</b>		<b>100.0</b>
<b>Total</b>		<b>100.0</b>

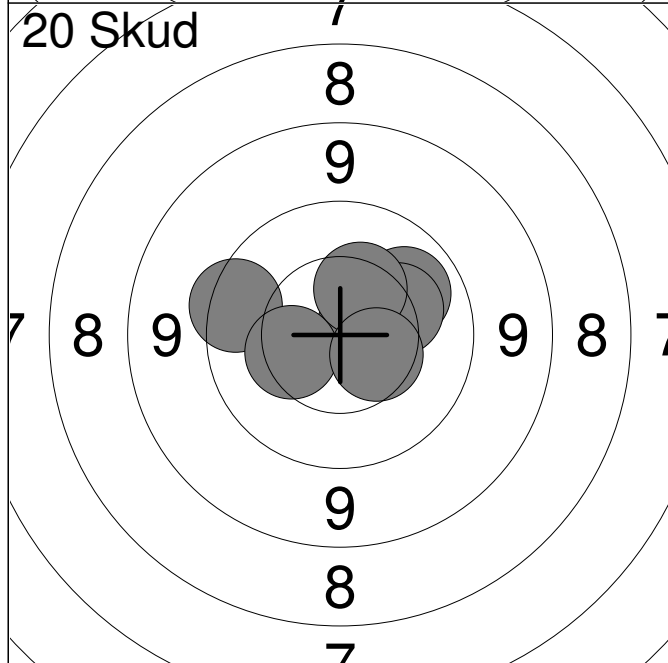

11:	9.7	←
12:	10.5	↗
13:	10.1	↗
14:	10.4	→
15:	10.6x	→
16:	10.7x	→
17:	10.2	↗
18:	10.4	←
19:	10.4	↑
20:	10.5	↘
<b>Serie</b>		<b>99.0</b>
<b>Total</b>		<b>199.0</b>

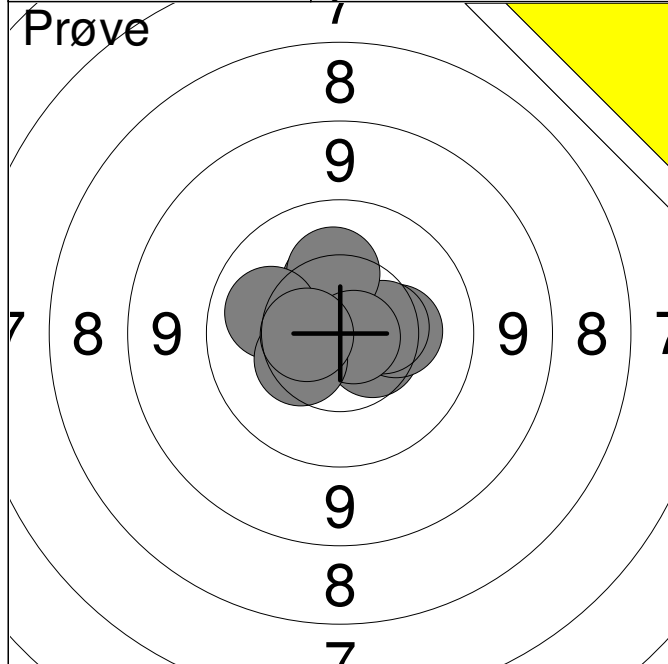

1:	10.5	↘
2:	10.6x	↗
3:	10.3	→
4:	10.5	→
5:	10.4	↗
6:	10.3	↗
7:	10.1	↖
8:	10.8x	→
9:	10.4	↖
10:	10.6	←
<b>Serie</b>	<b>100.0</b>	
<b>Total</b>	<b>0.0</b>	

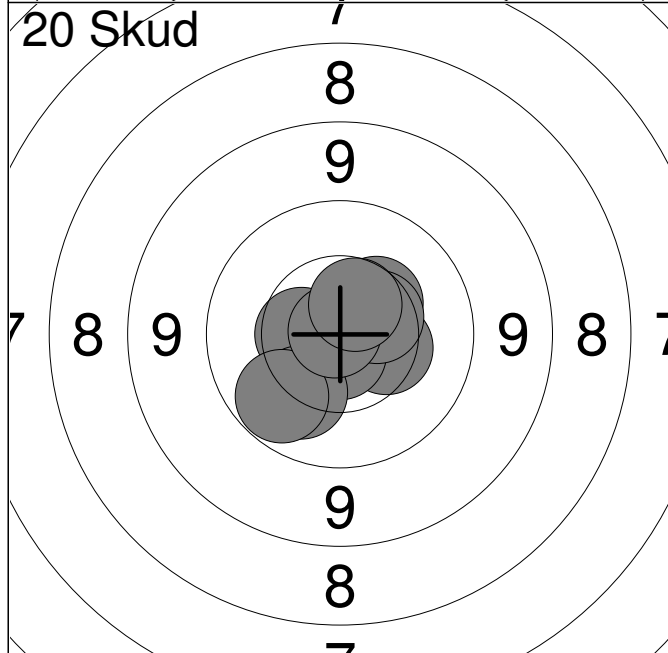

1:	10.4	↗
2:	10.7x	↘
3:	10.4	→
4:	10.7x	↘
5:	10.5	←
6:	10.5	↗
7:	10.1	↘
8:	10.0	↘
9:	10.9x	↗
10:	10.6	↗
<b>Serie</b>	<b>100.0</b>	
<b>Total</b>	<b>100.0</b>	

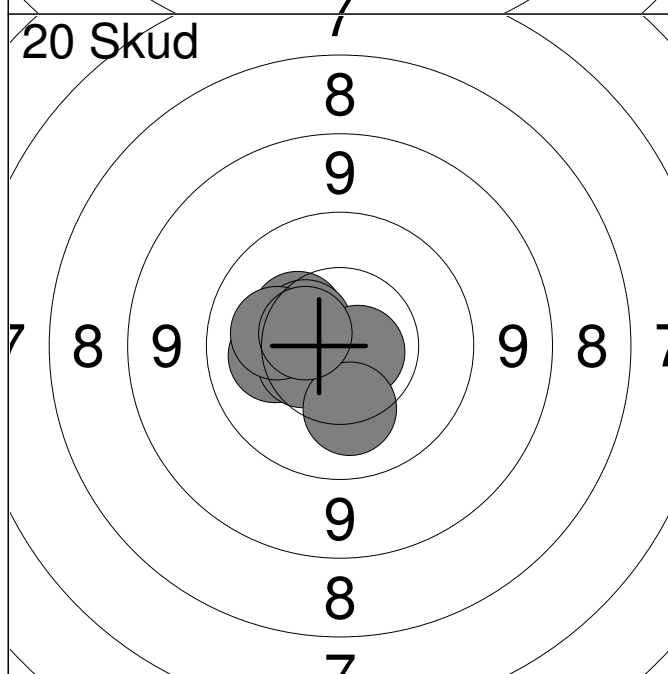

11:	10.4	↗
12:	10.6	←
13:	10.2	←
14:	10.4	↗
15:	10.5	↗
16:	10.5	↖
17:	10.7x	→
18:	10.2	↖
19:	10.2	↘
20:	10.5	↖
<b>Serie</b>	<b>100.0</b>	
<b>Total</b>	<b>200.0</b>	

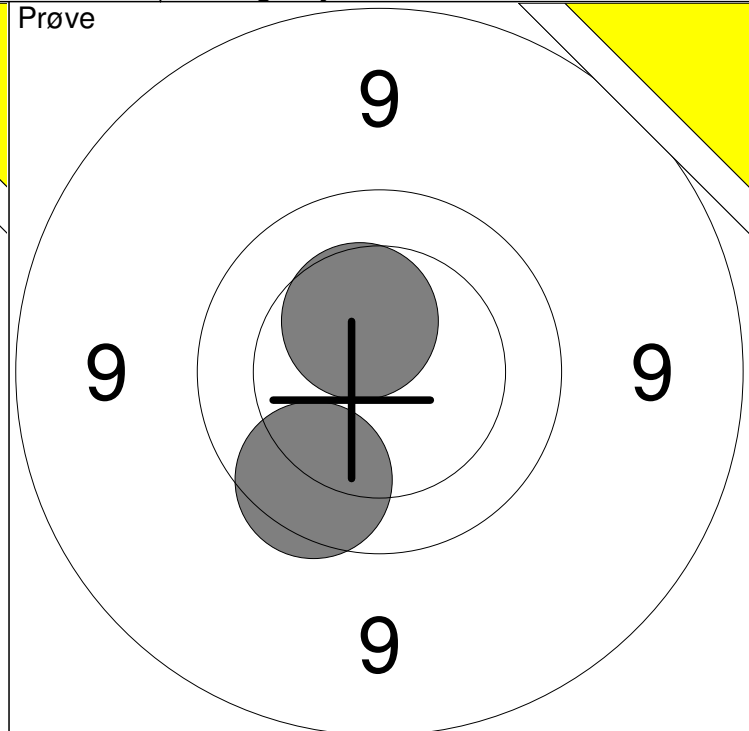
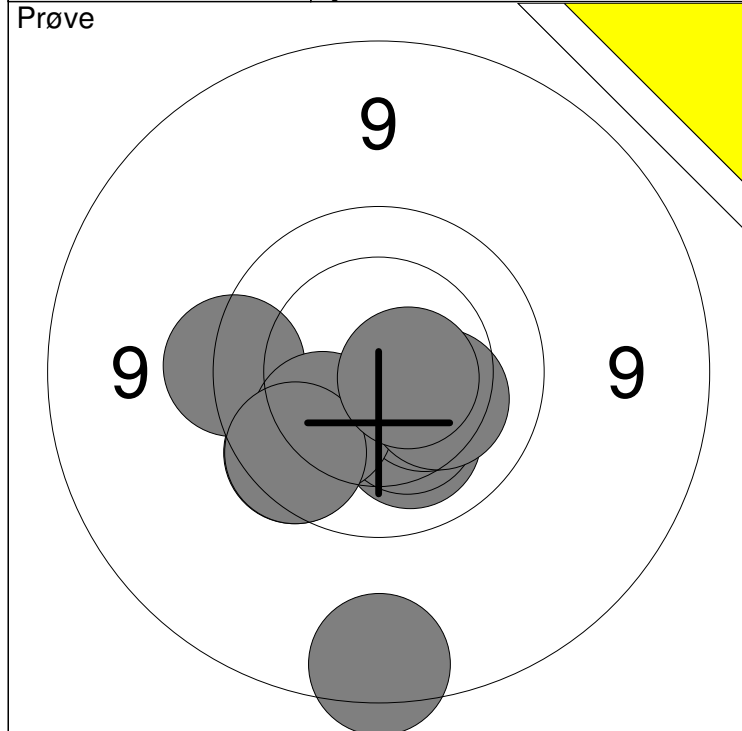

1: 8.8 ↓	6: 10.4 ↘	Serie	95
2: 9.8 ↙	7: 10.1 ↙		
3: 10.2 ↓	8: 10.2 ↘	Total	0
4: 10.3 ↓	9: 9.8 ↙		
5: 9.6 ←	10: 10.6x ↘		

11: 9.8 ↙	Serie	19
12: 10.4 ↗		
Total		0

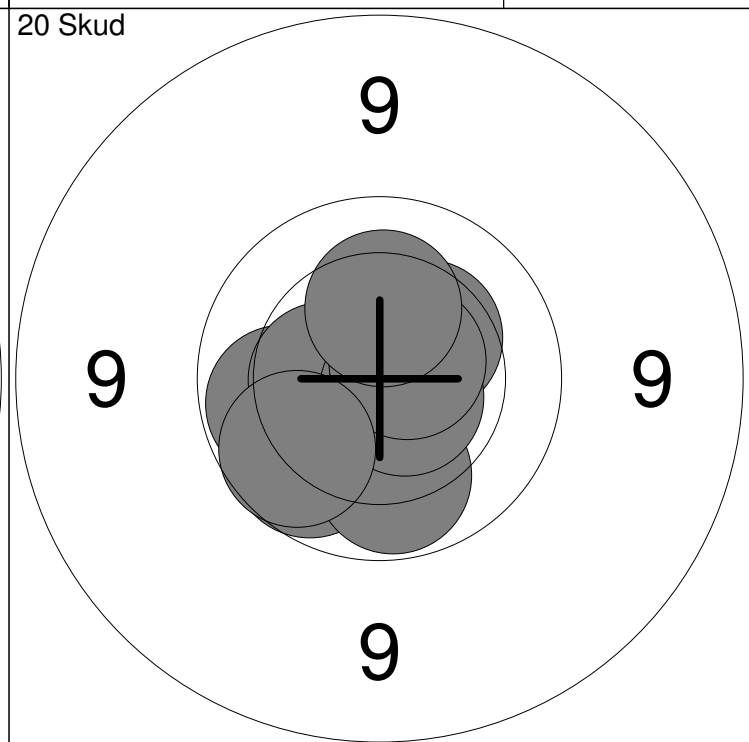
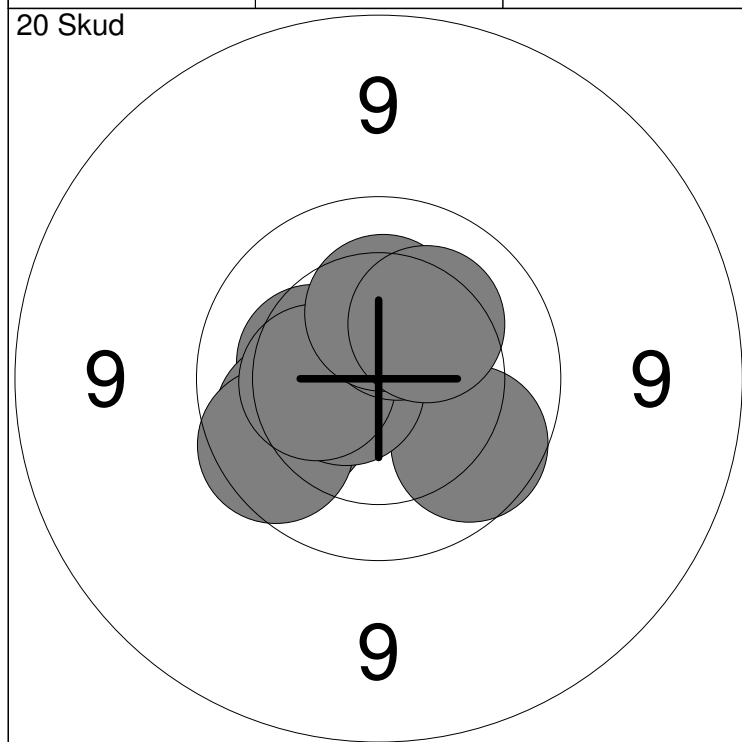

1: 10.3 ←	6: 10.6x ←	Serie	98
2: 10.3 ←	7: 10.4 ←		
3: 10.0 ←	8: 10.4 ↗	Total	98
4: 9.9 ↘	9: 10.3 ↗		
5: 9.8 ←	10: 10.3 ↗		

11: 10.4 ↗	16: 10.7x ↘	Serie	98
12: 9.9 ↙	17: 10.6x ↘		
13: 10.0 ←	18: 10.6x ↗	Total	196
14: 10.0 ↓	19: 9.9 ↙		
15: 10.4 ←	20: 10.3 ↗		

Hold	Skive	Pernille Nielsen	
25	12	Vilsted Skf.	MJ2
15m	Jyllandsstævne 2015		Aalborg Skyttekreds
11.02.2015			
Prøve		1: 9.3	↖
		2: 10.4	↑
		3: 10.6x	↗
		4: 9.6	↖
		5: 10.4	↙
		6: 10.3	↑
		<b>Serie</b>	<b>58.0</b>
		<b>Total</b>	<b>0.0</b>
20 Skud		1: 9.2	↖
		2: 10.5x	↖
		3: 10.7x	↖
		4: 9.6	↖
		5: 9.8	↖
		6: 9.8	↖
		7: 10.5x	→
		8: 10.5x	↖
		9: 10.6x	↖
		10: 10.4	↗
		<b>Serie</b>	<b>96.0</b>
		<b>Total</b>	<b>96.0</b>
20 Skud		11: 8.7	→
		12: 10.2	↙
		13: 9.9	↙
		14: 9.9	↖
		15: 10.2	↗
		16: 10.6x	↖
		17: 9.4	→
		18: 9.9	↖
		19: 9.8	→
		20: 10.1	↗
		<b>Serie</b>	<b>93.0</b>
		<b>Total</b>	<b>189.0</b>

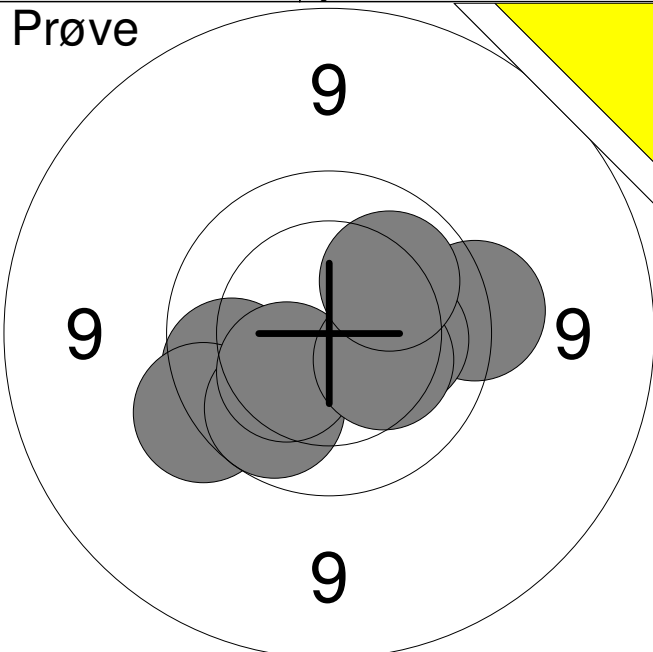
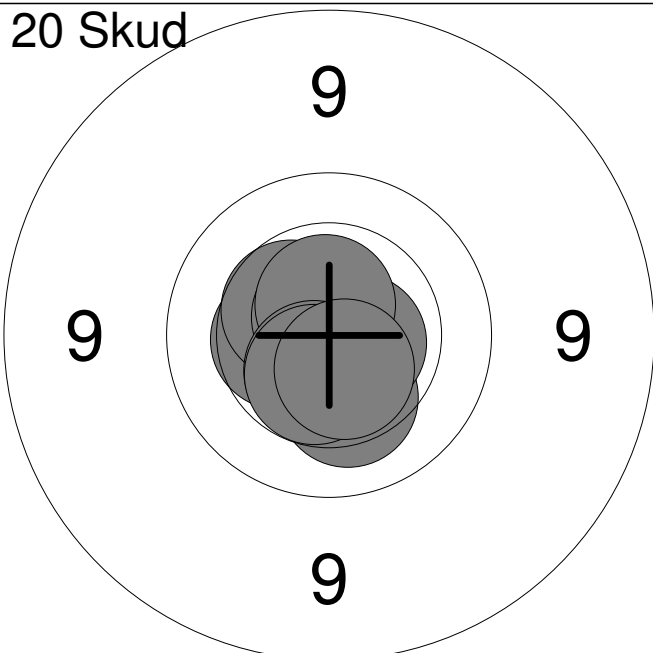
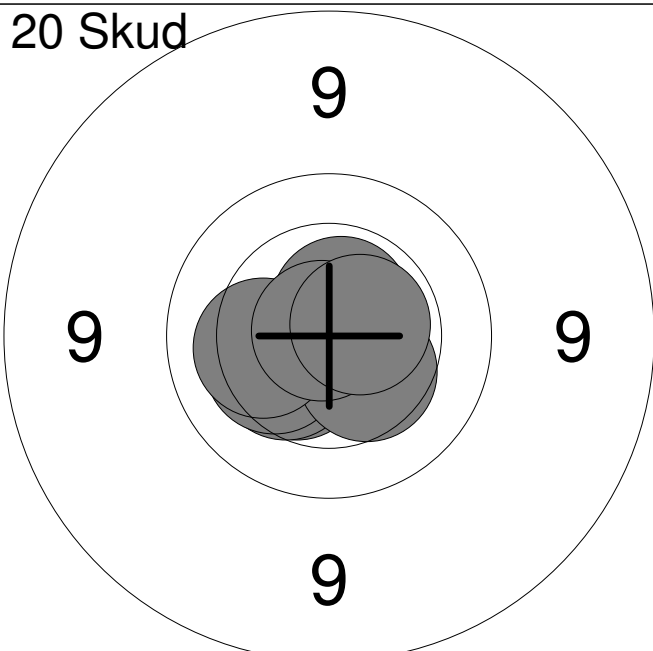
Hold	Skive	Sune Grøn Bendixen	
26	1		
15m	Hjørring Skytteforening	BK2	
11.02.2015	Jyllandsstævne 2015	Aalborg Skyttekreds	
Prøve		1: 9.6 →	
		2: 9.9 ←	
		3: 9.6 ←	
		4: 9.9 ↓	
		5: 10.3 ↓	
		6: 10.2 →	
		8: 10.3 ↘	
		9: 10.1 ↗	
		<b>Serie</b>	<b>76.0</b>
		<b>Total</b>	<b>0.0</b>
20 Skud		1: 10.6x ←	
		2: 10.2 ↓	
		3: 10.6x →	
		4: 10.4 ←	
		5: 10.5 ↗	
		6: 10.7x ↗	
		7: 10.6x ↑	
		8: 10.5x ↓	
		9: 10.5x ↓	
		10: 10.5x ↓	
		<b>Serie</b>	<b>100.0</b>
		<b>Total</b>	<b>100.0</b>
20 Skud		11: 10.4 ↓	
		12: 10.4 ←	
		13: 10.8x ↓	
		14: 10.6x ↑	
		15: 10.4 ↓	
		16: 10.3 ←	
		17: 10.4 ↓	
		18: 10.2 ←	
		19: 10.9x ↗	
		20: 10.6x →	
		<b>Serie</b>	<b>100.0</b>
		<b>Total</b>	<b>200.0</b>

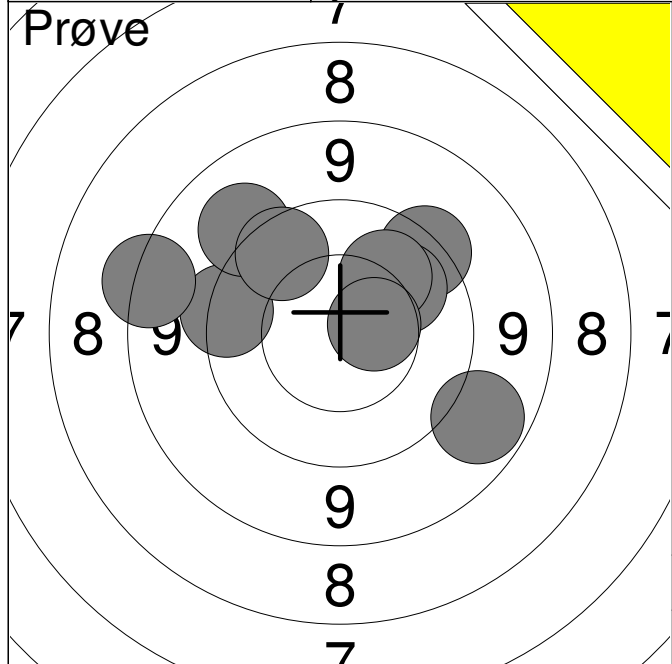

1:	9.0	↘
2:	9.6	↗
3:	9.6	←
4:	9.3	↗
5:	10.1	↗
6:	10.1	↗
7:	9.8	↗
8:	8.5	←
9:	10.5	→

<b>Serie</b>	<b>83.0</b>
<b>Total</b>	<b>0.0</b>

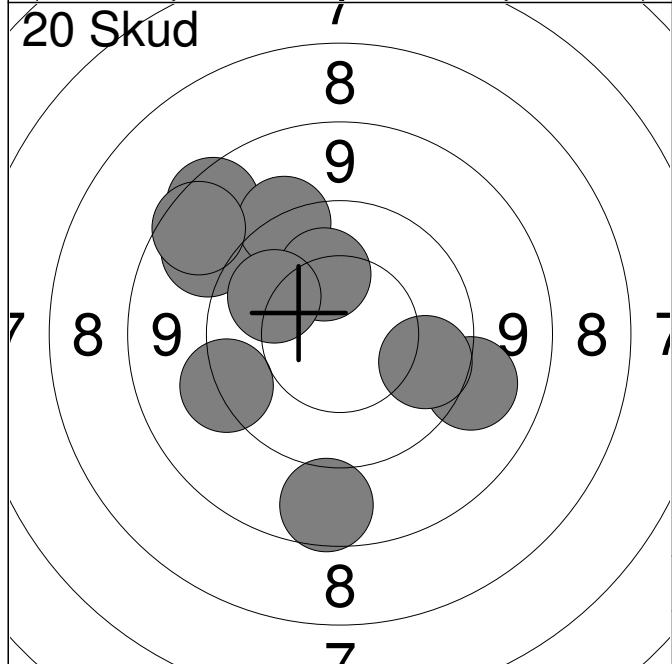

1:	9.1	↗
2:	9.3	↘
3:	9.9	↘
4:	9.5	←
5:	8.7	↗
6:	9.5	↗
7:	10.2	↗
8:	8.9	↘
9:	10.1	↗
10:	8.8	↗

<b>Serie</b>	<b>89.0</b>
<b>Total</b>	<b>89.0</b>

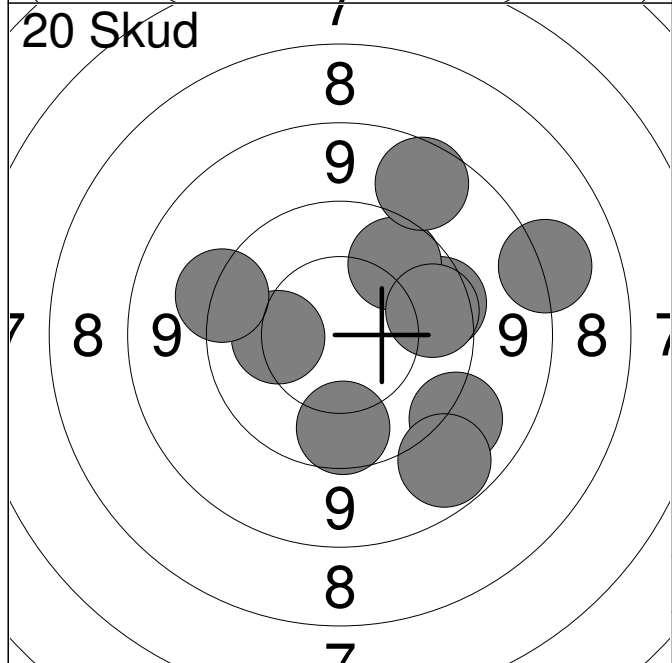

11:	9.2	↘
12:	9.7	→
13:	10.2	←
14:	9.9	↗
15:	9.5	←
16:	9.0	↘
17:	8.3	→
18:	9.9	↘
19:	8.9	↗
20:	9.8	→

<b>Serie</b>	<b>89.0</b>
<b>Total</b>	<b>178.0</b>

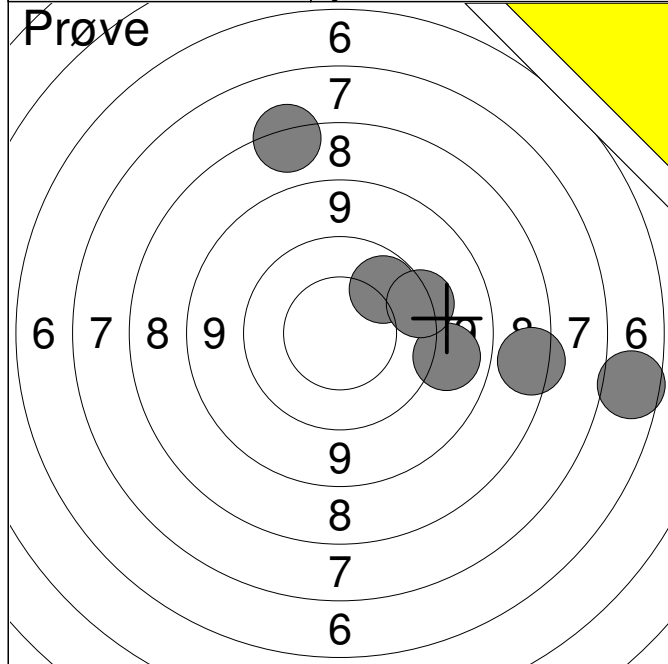

1:	10.0	↗
2:	7.7	→
3:	9.1	→
4:	9.6	→
5:	5.9	→
6:	7.5	↑
<b>Serie</b>		<b>47.0</b>
<b>Total</b>		<b>0.0</b>

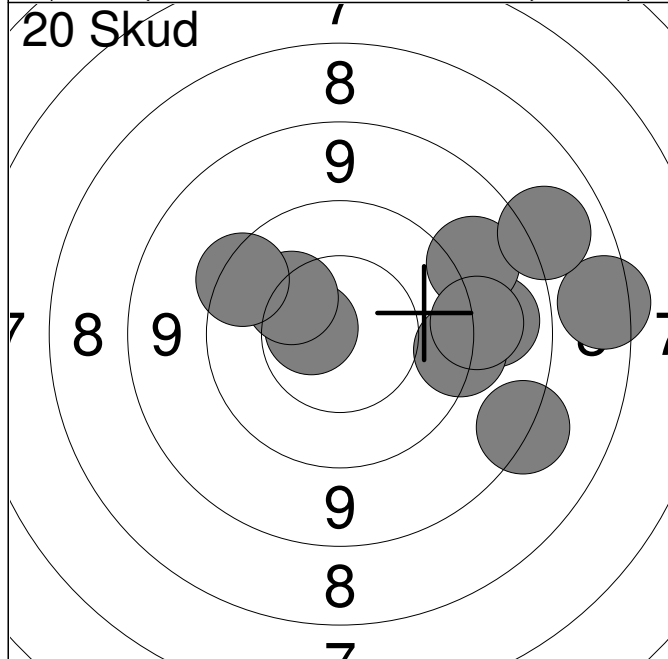

1:	7.7	→
2:	9.1	→
3:	9.1	→
4:	9.5	→
5:	8.1	→
6:	9.3	→
7:	10.6x	←
8:	8.4	↘
9:	10.2	↗
10:	9.6	↗
<b>Serie</b>		<b>88.0</b>
<b>Total</b>		<b>88.0</b>

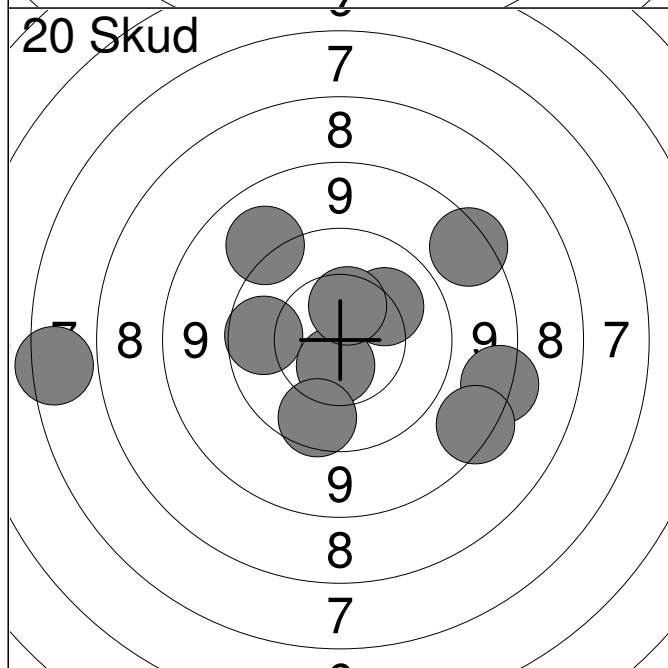

11:	9.9	←
12:	10.6	↓
13:	6.7	←
14:	8.6	↗
15:	9.2	↗
16:	9.8	↓
17:	10.2	↗
18:	10.5	↑
19:	8.5	→
20:	8.6	↘
<b>Serie</b>		<b>87.0</b>
<b>Total</b>		<b>175.0</b>

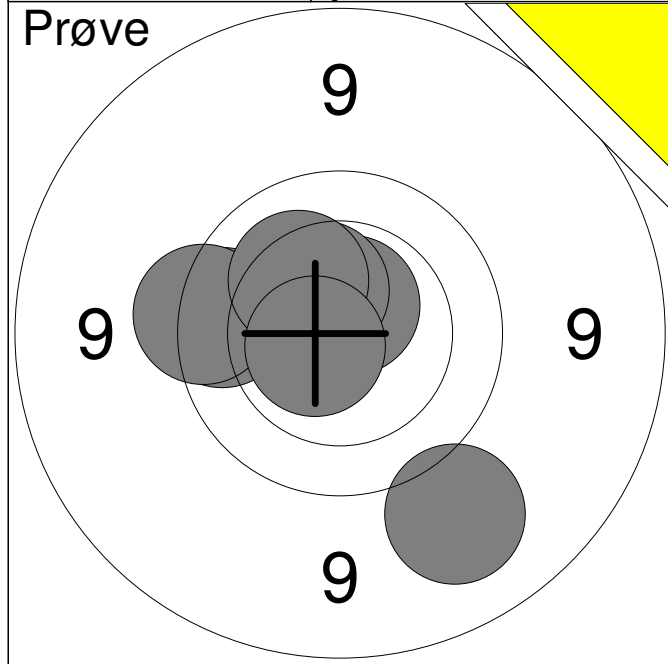

1:	9.2	↓
2:	9.8	←
3:	10.6x	↑
4:	9.7	←
5:	10.4	↑
6:	10.2	↑
7:	10.6x	←
<b>Serie</b>		<b>67.0</b>
<b>Total</b>		<b>0.0</b>

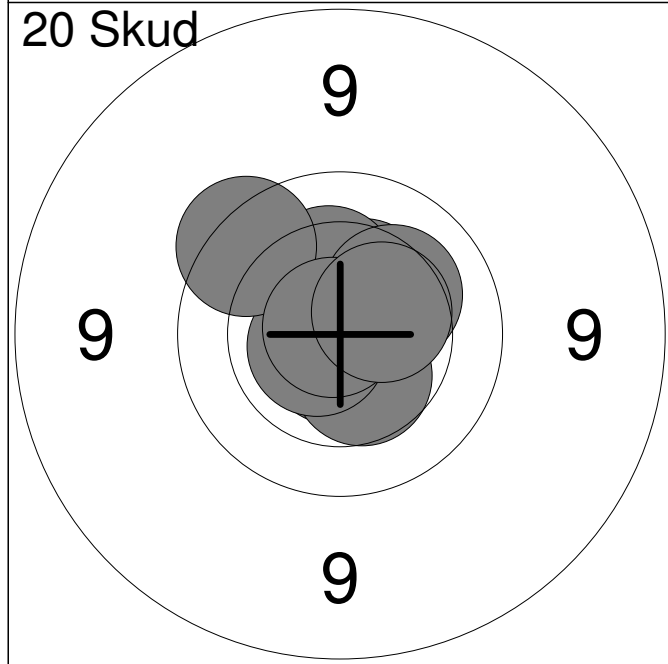

1:	10.7x	↓
2:	10.8x	↓
3:	10.4	↓
4:	10.4	↑
5:	10.3	↑
6:	10.2	↗
7:	10.7x	←
8:	9.7	↑
9:	10.8x	↑
10:	10.4	↗
<b>Serie</b>		<b>99.0</b>
<b>Total</b>		<b>99.0</b>

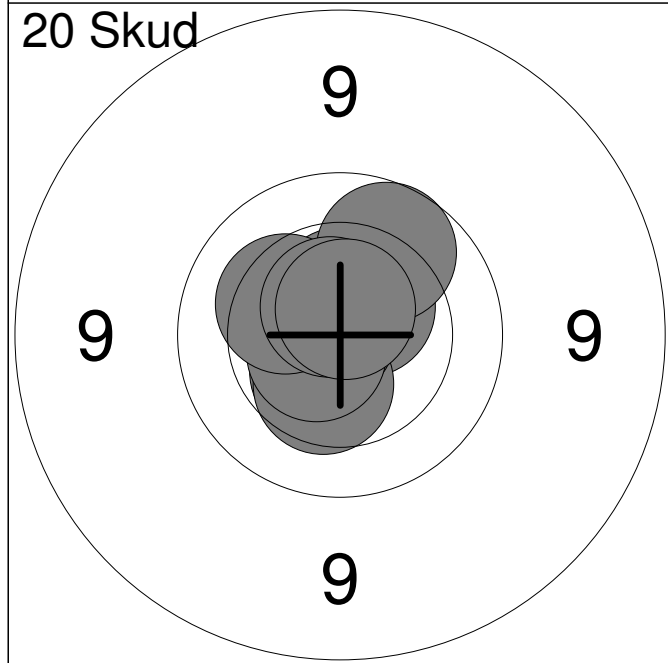

11:	10.5x	↑
12:	10.5x	↗
13:	10.5x	↓
14:	10.4	↓
15:	10.8x	←
16:	10.6x	←
17:	9.9	↑
18:	10.3	↗
19:	10.6x	↑
20:	10.7x	↑
<b>Serie</b>		<b>99.0</b>
<b>Total</b>		<b>198.0</b>



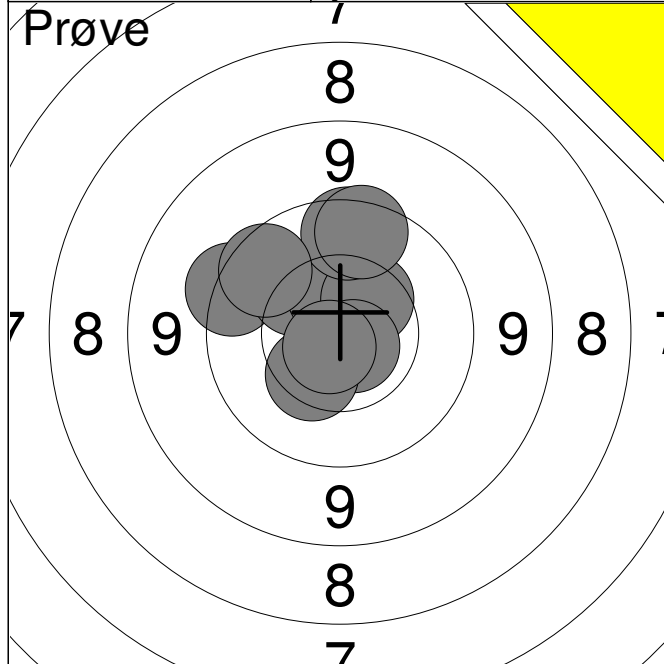

1:	9.6	↗
2:	10.2	↗
3:	10.5	↑
4:	10.4	↗
5:	9.8	↑
6:	10.7x	↘
7:	9.7	↑
8:	9.8	↗
9:	10.4	↘
10:	10.7x	↘
<b>Serie</b>		<b>96.0</b>
<b>Total</b>		<b>0.0</b>

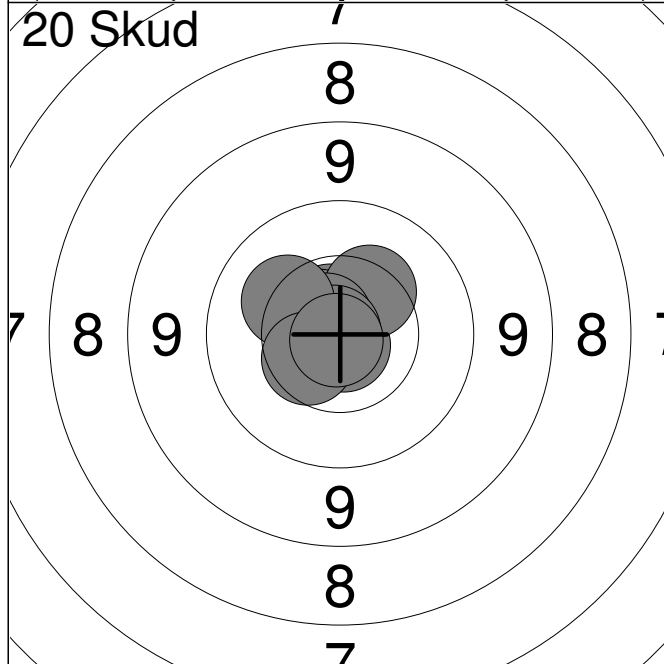

1:	10.7x	↗
2:	10.8x	↘
3:	10.6x	↗
4:	10.9x	←
5:	10.4	↗
6:	10.7x	↗
7:	10.9x	↗
8:	10.2	↗
9:	10.5	↘
10:	10.9x	↘
<b>Serie</b>		<b>100.0</b>
<b>Total</b>		<b>100.0</b>

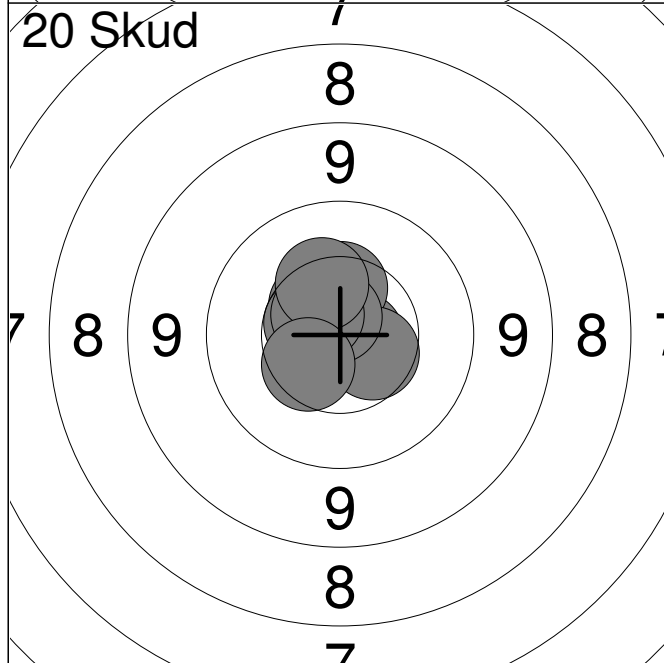

11:	10.7x	→
12:	10.6x	←
13:	10.5	↗
14:	10.4	↑
15:	10.5	↘
16:	10.7x	↗
17:	10.6	↗
18:	10.6x	↗
19:	10.3	↗
20:	10.4	↘
<b>Serie</b>		<b>100.0</b>
<b>Total</b>		<b>200.0</b>

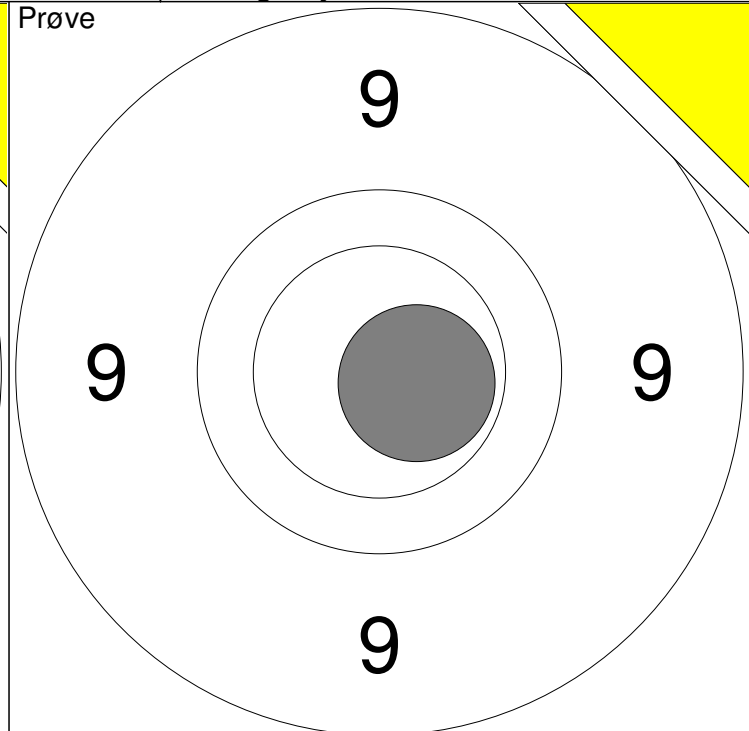
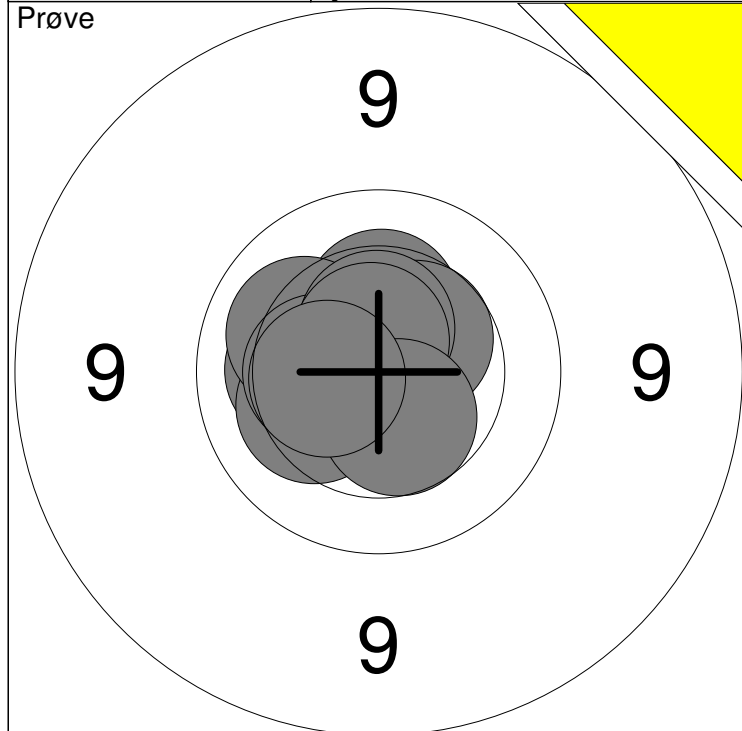

1: 10.3 ↑	6: 10.5 ↗	Serie	100
2: 10.2 ←	7: 10.5x ↑		
3: 10.3 ↙	8: 10.6x ↑	Total	0
4: 10.1 ↖	9: 10.5 ↓		
5: 10.4 ←	10: 10.5 ←		

11: 10.6x →		Serie	10
		Total	0

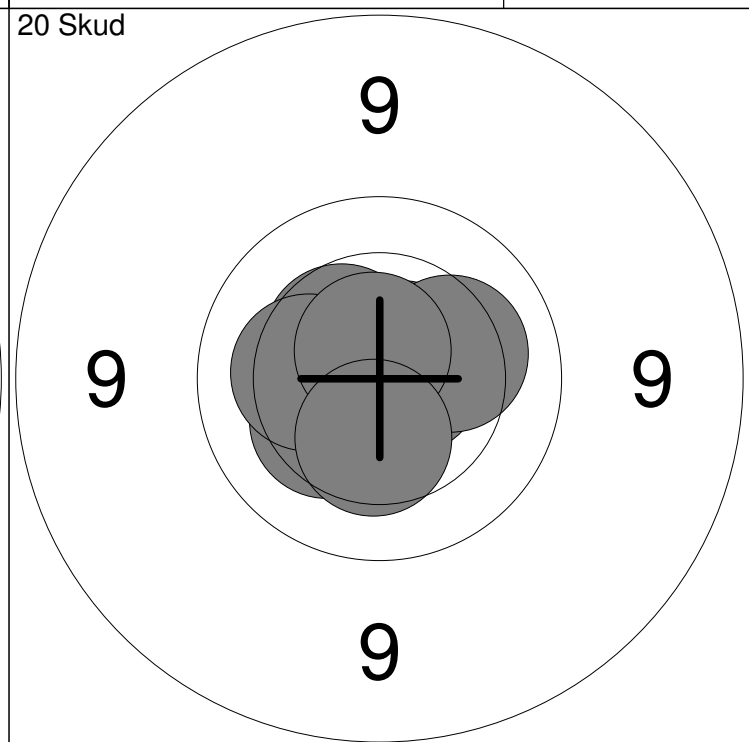
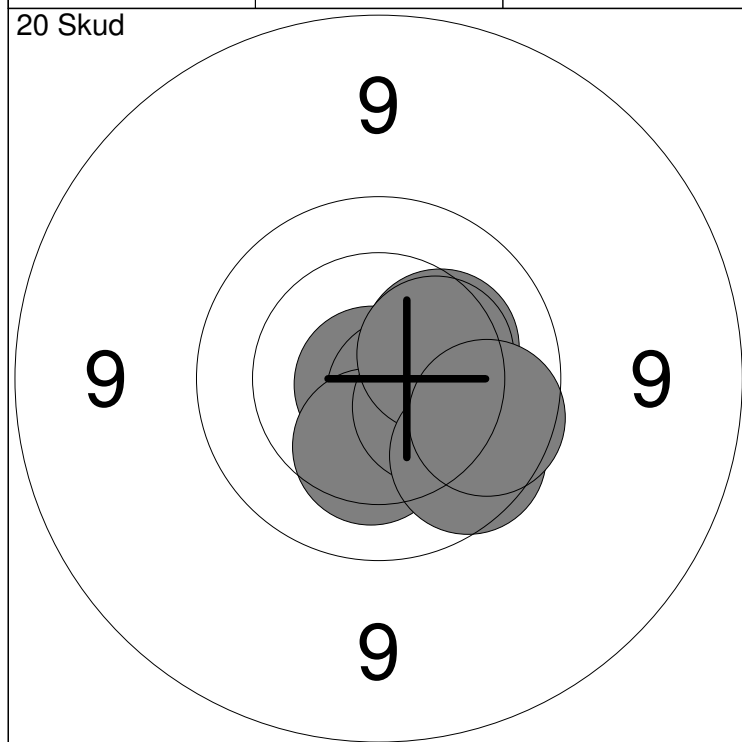

1: 10.7x →	6: 10.3 ↗	Serie	98
2: 10.4 →	7: 10.4 ↘		
3: 10.9x ↙	8: 10.4 →	Total	98
4: 10.7x ↘	9: 9.9 ↓		
5: 10.3 ↓	10: 9.9 ↘		

11: 10.4 ↖	16: 10.3 ←	Serie	100
12: 10.3 ↙	17: 10.7x ↗		
13: 10.7x →	18: 10.2 →	Total	198
14: 10.8x ←	19: 10.7x ↑		
15: 10.5 ←	20: 10.4 ↓		

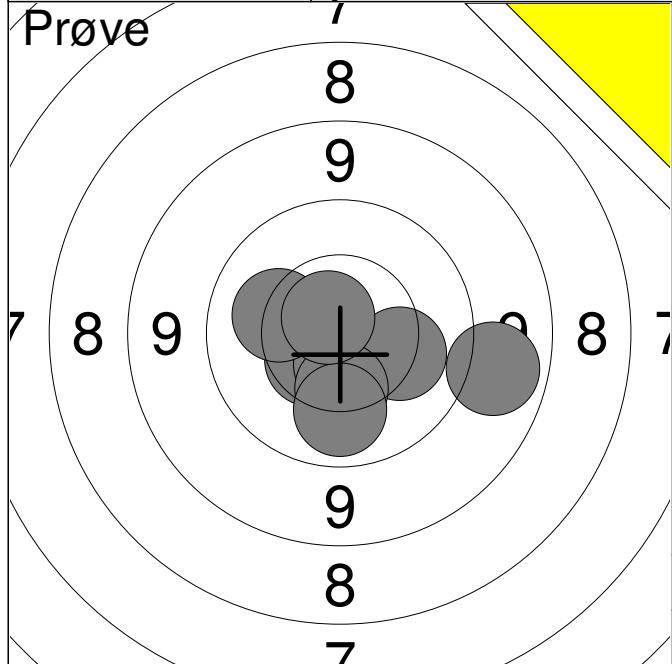

1:	10.5	↙
2:	9.1	→
3:	10.6x	↓
4:	10.2	↘
5:	10.2	↗
6:	10.3	↓
7:	10.1	↓
8:	10.7x	↗
<b>Serie</b>		<b>79.0</b>
<b>Total</b>		<b>0.0</b>

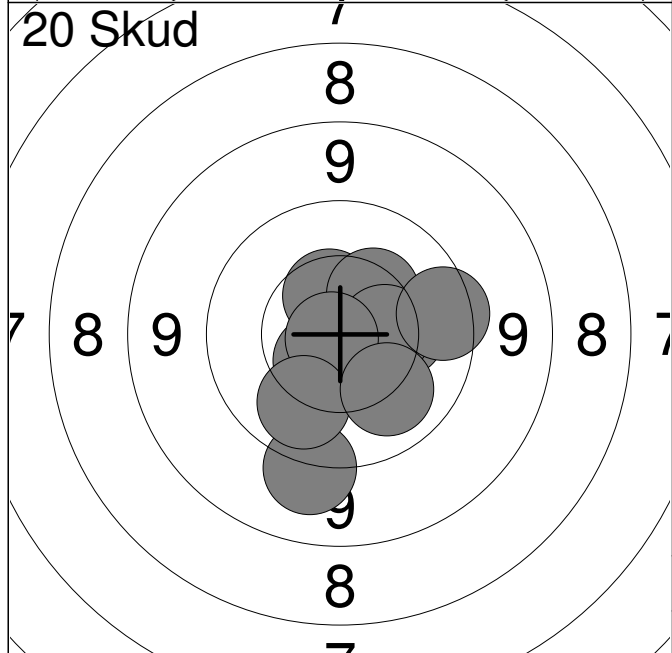

1:	10.3	→
2:	10.5	↗
3:	10.4	↗
4:	10.6	↙
5:	10.4	→
6:	9.3	↓
7:	10.8x	↙
8:	10.1	↓
9:	9.7	→
10:	10.1	↓
<b>Serie</b>		<b>98.0</b>
<b>Total</b>		<b>98.0</b>

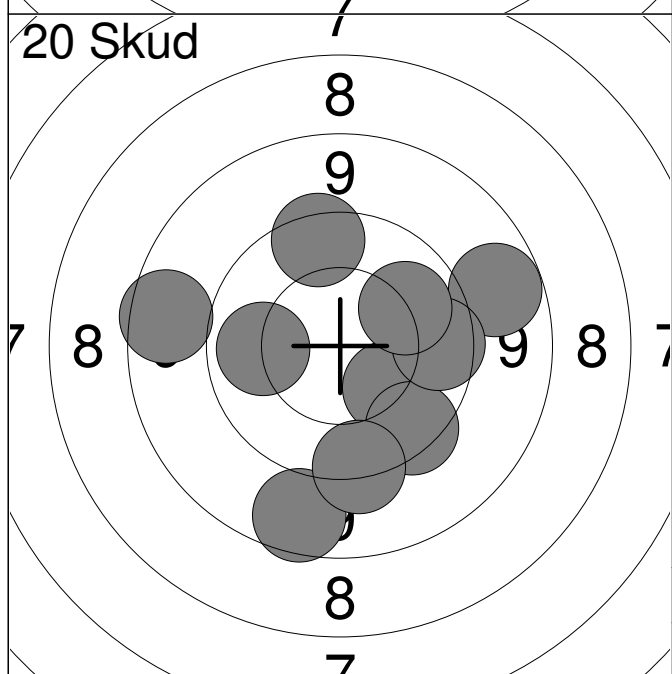

11:	10.2	↘
12:	9.0	→
13:	9.7	↘
14:	9.8	→
15:	10.1	←
16:	8.8	↓
17:	9.5	↓
18:	9.7	↗
19:	10.1	↗
20:	8.8	←
<b>Serie</b>		<b>91.0</b>
<b>Total</b>		<b>189.0</b>

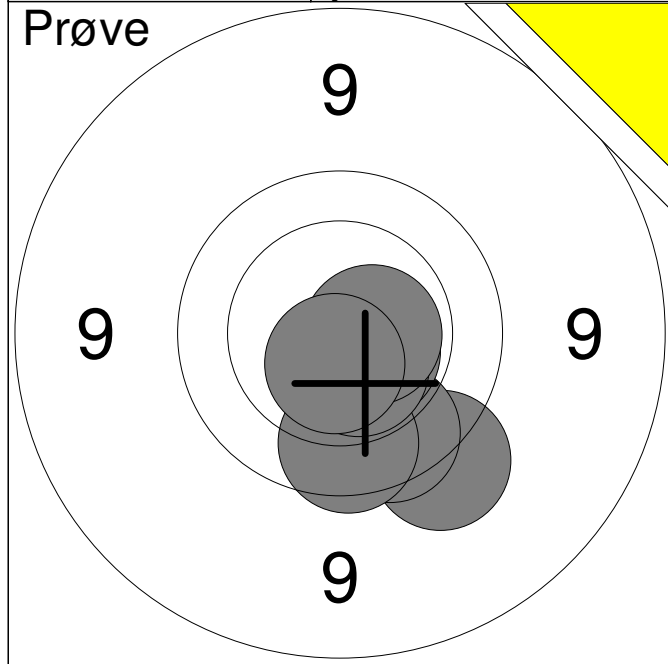

1:	9.5	↘
2:	9.8	↘
3:	9.8	↘
4:	10.6x	↘
5:	10.5x	↘
6:	10.6x	→
7:	10.6x	↘
<b>Serie</b>	<b>67.0</b>	
<b>Total</b>	<b>0.0</b>	

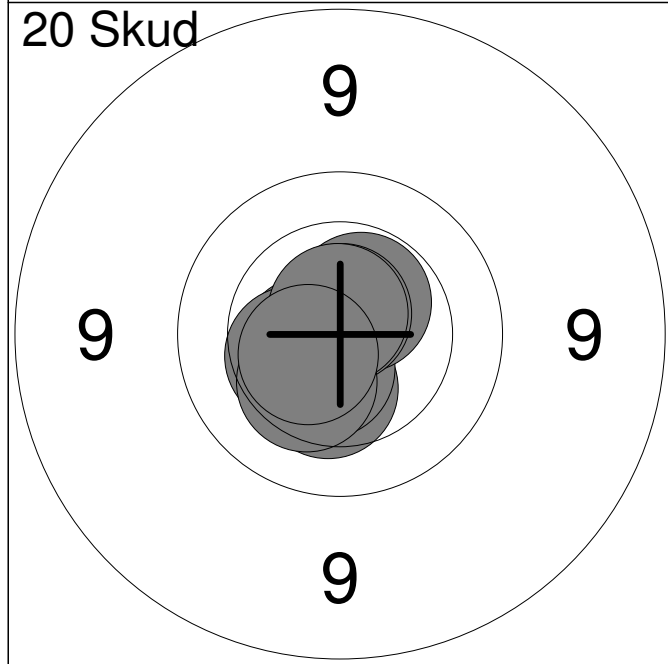

1:	10.6x	↙
2:	10.5x	↙
3:	10.3	↘
4:	10.5x	↘
5:	10.5x	↗
6:	10.4	↙
7:	10.7x	↑
8:	10.3	↘
9:	10.7x	↑
10:	10.5x	↙
<b>Serie</b>	<b>100.0</b>	
<b>Total</b>	<b>100.0</b>	

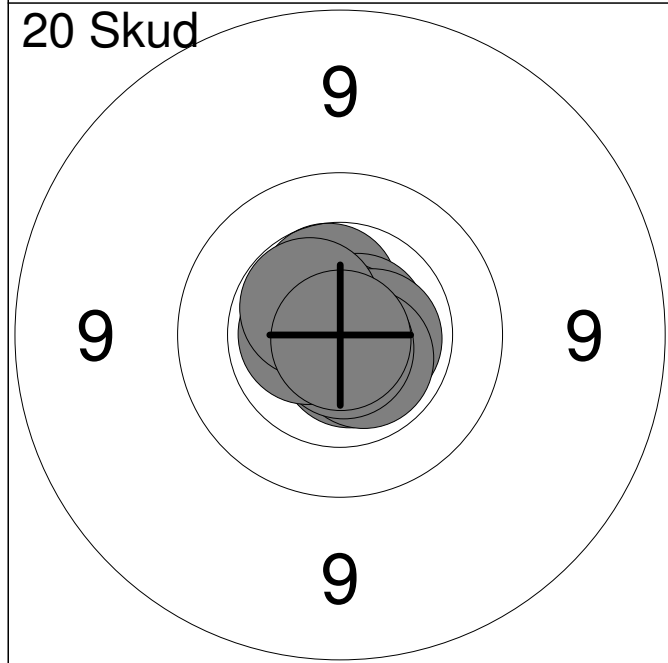

11:	10.5	↑
12:	10.7x	↗
13:	10.7x	↘
14:	10.9x	↗
15:	10.6x	→
16:	10.6x	↘
17:	10.8x	↘
18:	10.6x	↙
19:	10.5x	↗
20:	10.9x	↘
<b>Serie</b>	<b>100.0</b>	
<b>Total</b>	<b>200.0</b>	

Hold	Skive	Christian Bols Pedersen	
26	11	15m	Vester Hassing Skf. BK1
11.02.2015	Jyllandsstævne 2015	Aalborg Skyttekreds	
Prøve		1: 9.8 ↗	
		2: 10.6x ↖	
		3: 10.5 ↗	
		4: 10.8x ↖	
		5: 10.6x ↗	
		6: 10.8x ↖	
		7: 10.5x ↗	
		8: 10.7x ↗	
	Serie	79.0	
	Total	0.0	
20 Skud		1: 10.2 ↑	
		2: 10.7x →	
		3: 10.5 ↓	
		4: 10.7x ↗	
		5: 10.7x →	
		6: 10.5x ↑	
		7: 10.1 ←	
		8: 10.8x ↘	
		9: 10.5 ↗	
		10: 10.5 ↖	
	Serie	100.0	
	Total	100.0	
20 Skud		11: 10.8x →	
		12: 10.7x ↖	
		13: 10.2 ←	
		14: 10.8x ↗	
		15: 10.7x ↑	
		16: 10.8x ↓	
		17: 9.9 ↘	
		18: 10.6x ←	
		19: 10.6x ↑	
		20: 10.6x ←	
	Serie	99.0	
	Total	199.0	

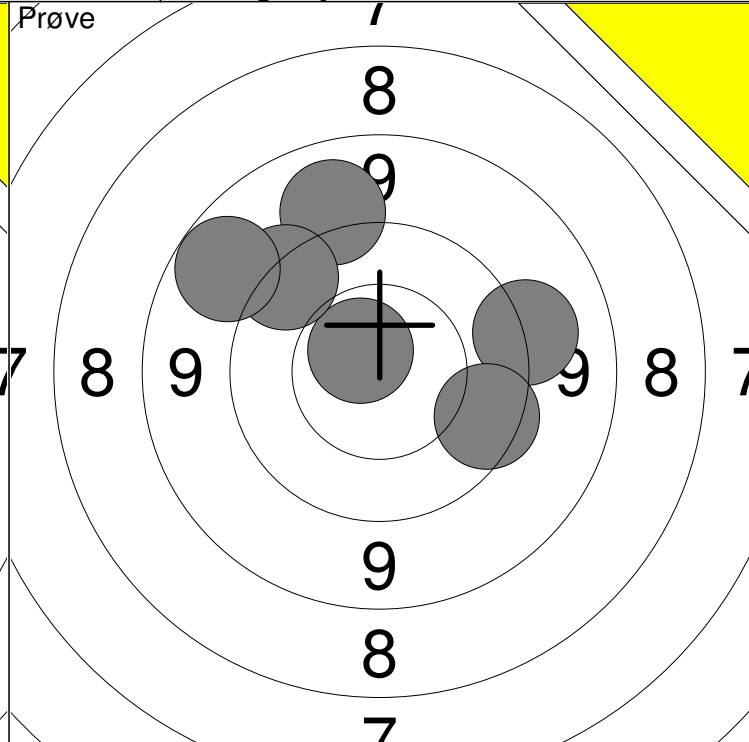
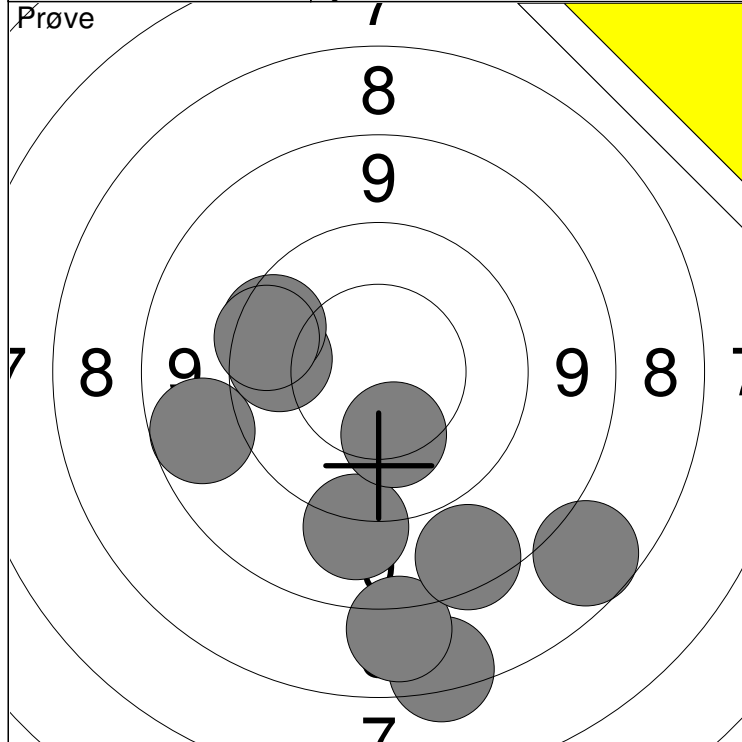

1: 7.6 ↓	6: 10.3 ↓	Serie 84
2: 8.1 ↓	7: 8.9 ←	
3: 7.9 ↓	8: 9.9 ←	Total 0
4: 8.7 ↓	9: 9.8 ↗	
5: 9.3 ↓	10: 9.7 ←	

11: 9.3 →	16: 9.0 ↖	Serie 55
12: 10.7x ↗	13: 9.2 ↗	
14: 9.7 ↘	15: 9.5 ↗	Total 0

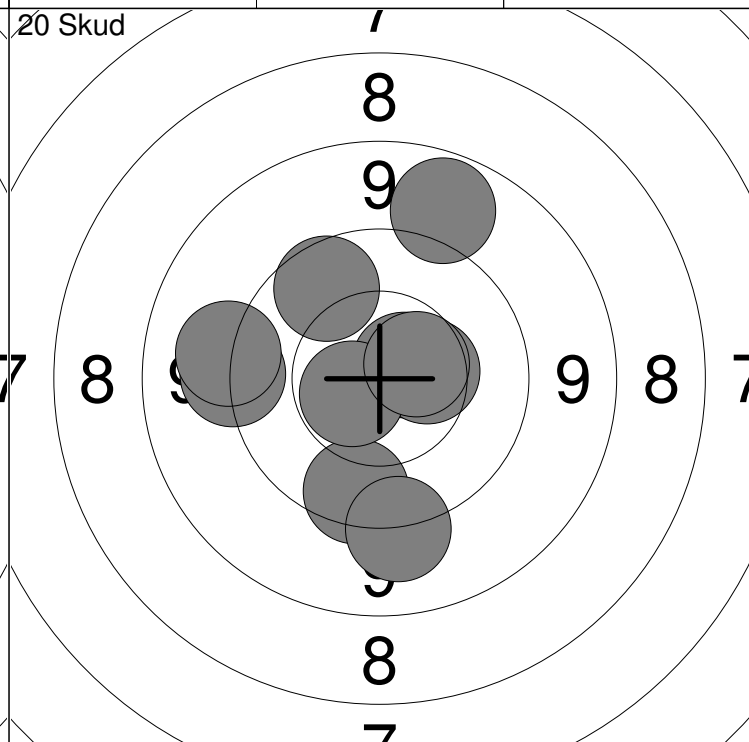
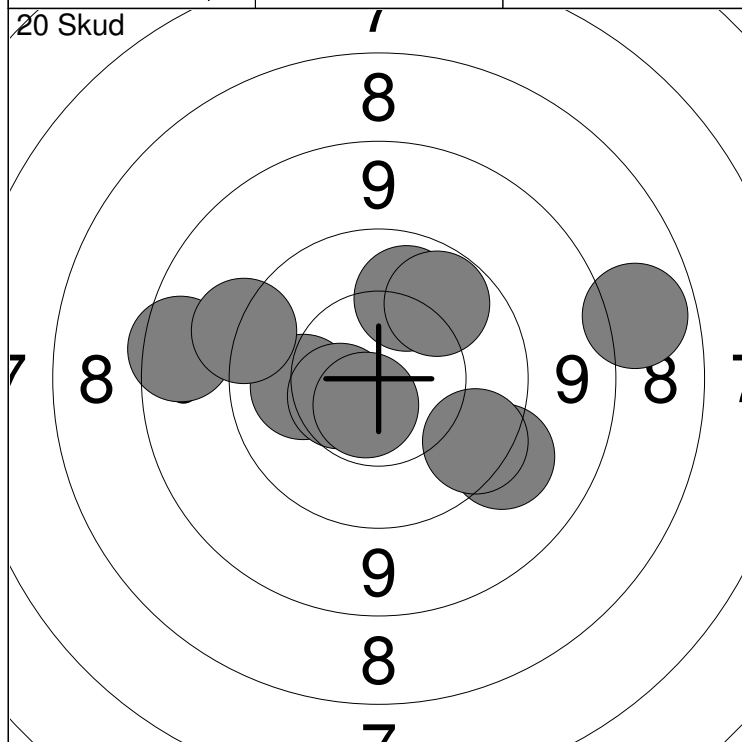

1: 10.2 ←	6: 10.0 ↗	Serie 93
2: 8.8 ←	7: 9.7 ↘	
3: 10.1 ↗	8: 8.1 →	Total 93
4: 10.5 ←	9: 10.6x ↓	
5: 9.4 ↘	10: 9.4 ←	

11: 10.7x ↗	16: 9.0 ↗	Serie 94
12: 10.4 →	17: 9.3 ←	
13: 9.4 ←	18: 9.9 ↗	Total 187
14: 9.7 ↓	19: 10.6x ←	
15: 9.3 ↓	20: 10.5 →	

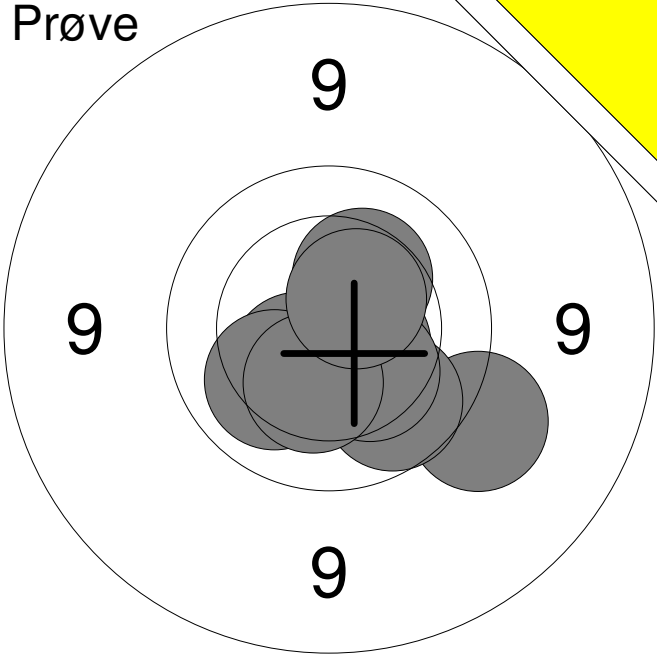
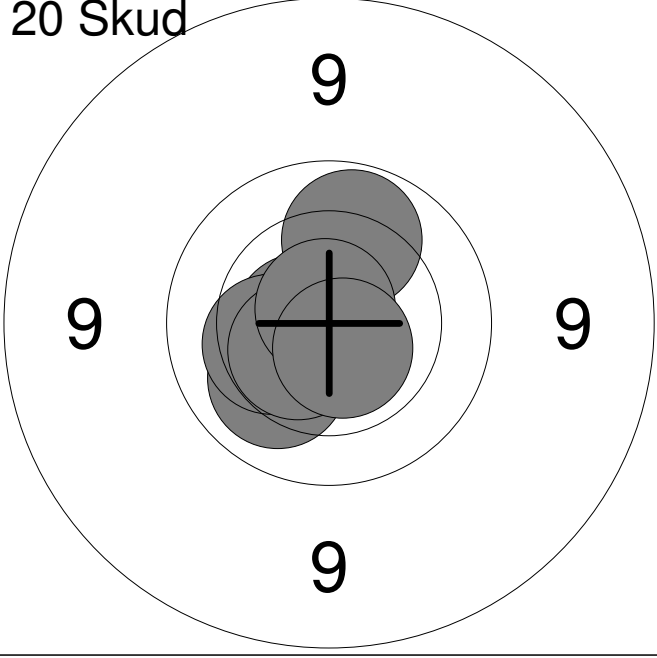
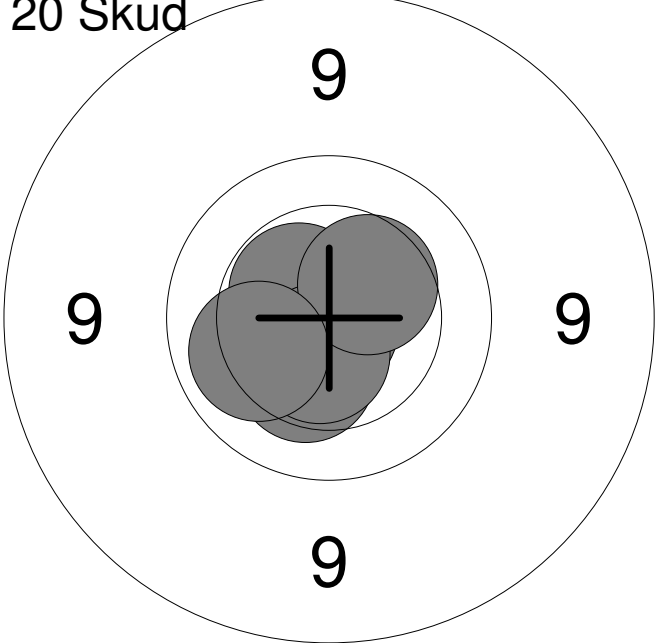
Hold	Skive	Thomas Grøn Bendixen	
27	1	Hjørring Skytteforening	BK1
15m		Jyllandsstævne 2015	Aalborg Skyttekreds
11.02.2015			
<b>Prøve</b> 	1:	9.4	↘
	2:	9.9	↘
	3:	10.6x	↘
	4:	10.5	↙
	5:	10.1	↙
	6:	10.3	↗
	7:	10.6x	↘
	8:	10.3	↘
	9:	10.3	↘
	10:	10.5x	↗
	<b>Serie</b>		<b>98.0</b>
<b>Total</b>		<b>0.0</b>	
<b>20 Skud</b> 	1:	10.7x	←
	2:	10.5	←
	3:	10.1	↙
	4:	10.7x	↘
	5:	10.3	←
	6:	10.8x	↘
	7:	10.0	↗
	8:	10.5x	↙
	9:	10.8x	↗
	10:	10.6x	↘
	<b>Serie</b>		<b>100.0</b>
<b>Total</b>		<b>100.0</b>	
<b>20 Skud</b> 	11:	10.6x	↙
	12:	10.8x	↙
	13:	10.3	↘
	14:	10.8x	↘
	15:	10.8x	↙
	16:	10.6x	↙
	17:	10.5x	↗
	18:	10.6x	↘
	19:	10.4	↗
	20:	10.1	←
	<b>Serie</b>		<b>100.0</b>
<b>Total</b>		<b>200.0</b>	

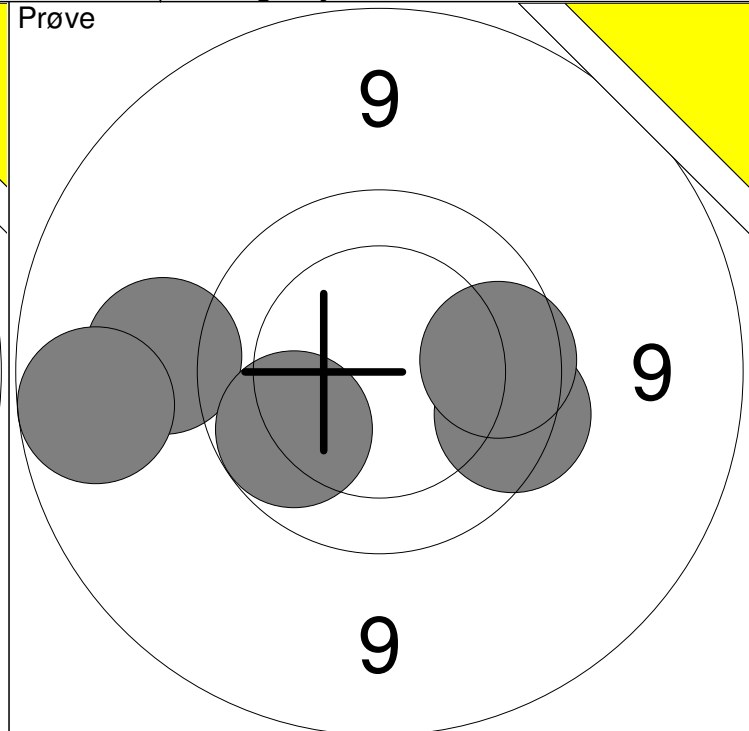
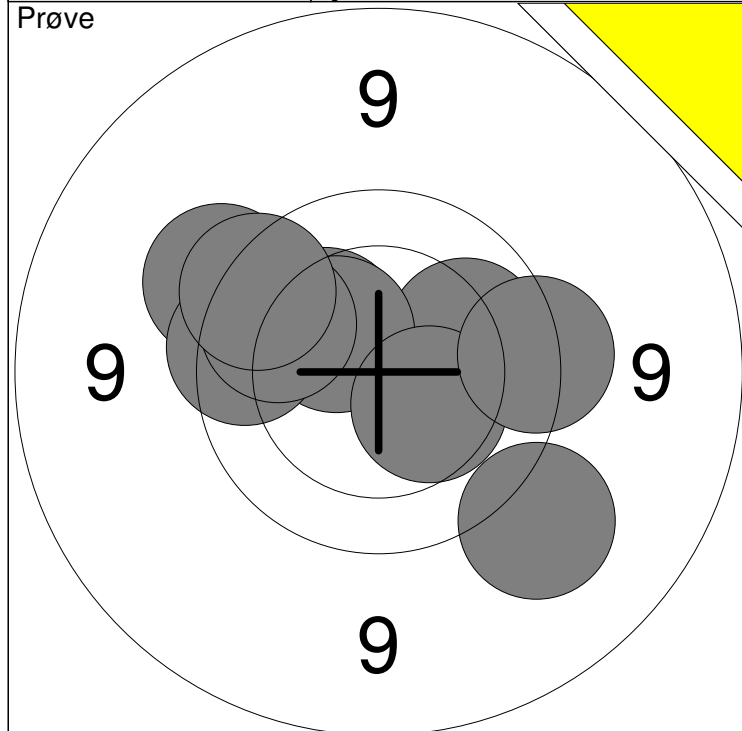

1: 9.5 ↗	6: 9.9 ↗	Serie	94
2: 10.3 ↗	7: 10.4 ↘		
3: 10.0 →	8: 9.7 →	Total	0
4: 10.4 ↗	9: 9.7 ↗		
5: 9.8 ←	10: 9.3 ↘		

11: 9.8 →	Serie	46
12: 9.9 →		
13: 9.3 ←	Total	0
14: 9.0 ←		
15: 10.0 ↙		

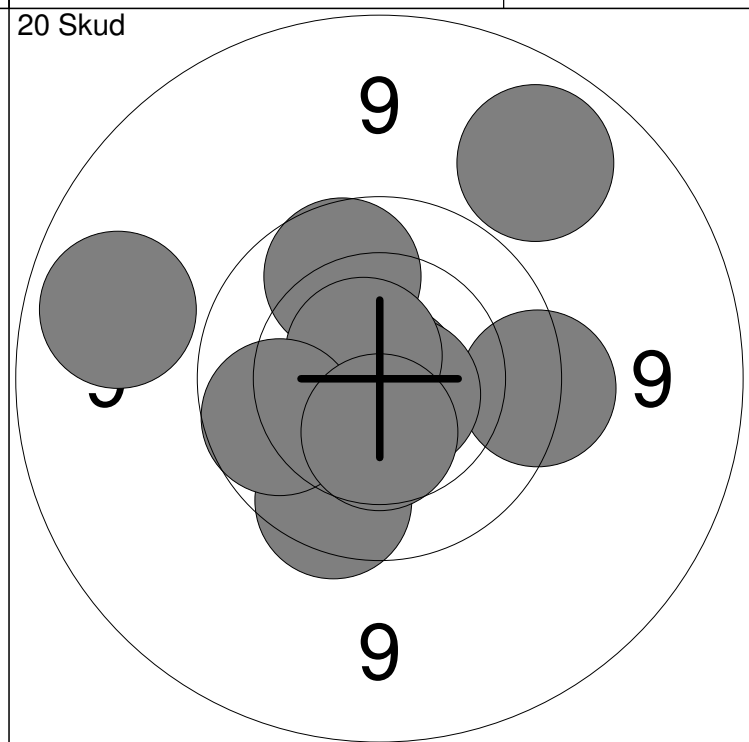
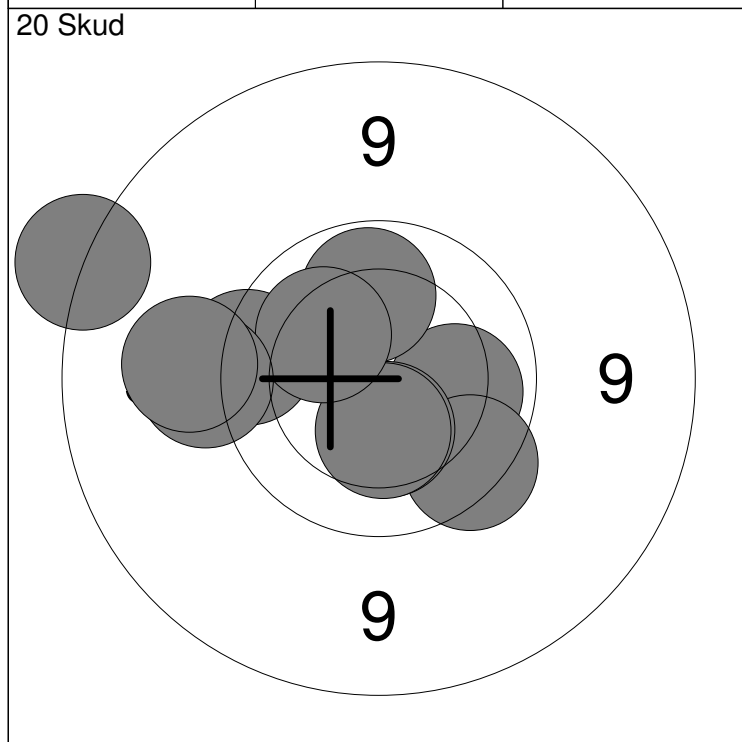

1: 10.1 →	6: 8.7 ↖	Serie	94
2: 9.7 ↘	7: 10.4 ↘		
3: 10.4 ↘	8: 10.2 ↗	Total	94
4: 9.7 ←	9: 9.4 ←		
5: 10.0 ↑	10: 9.3 ←		

11: 9.9 ↗	16: 10.7x ↘	Serie	94
12: 9.8 ↘	17: 10.7x ↗		
13: 9.6 →	18: 9.9 ←	Total	188
14: 9.0 ←	19: 9.1 ↗		
15: 10.9x →	20: 10.4 ↘		



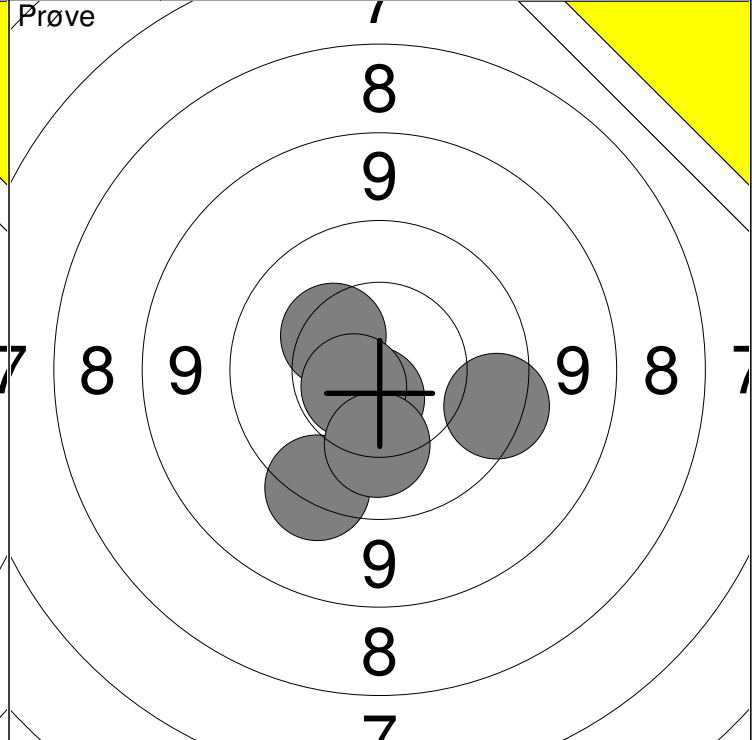
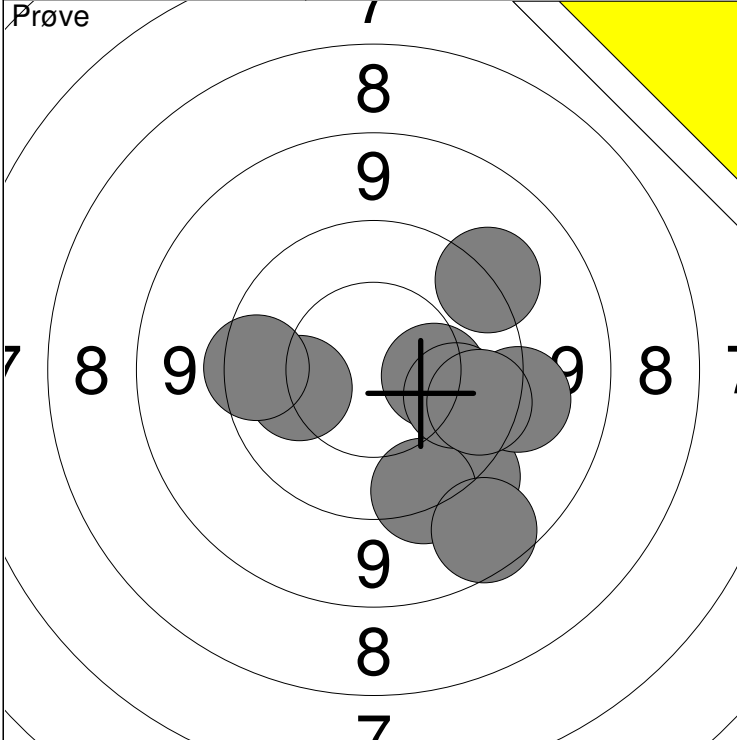

1: 9.4 ↘	6: 10.2 ←	Serie 92
2: 9.6 ↘	7: 9.4 →	
3: 8.8 ↘	8: 10.1 →	Total 0
4: 10.3 →	9: 9.7 ←	
5: 9.4 ↗	10: 9.8 →	

11: 10.4 ↗	16: 10.2 ↓	Serie 58
12: 9.5 ↘		
13: 9.7 →		Total 0
14: 10.6x ↘		
15: 10.6x ↙		

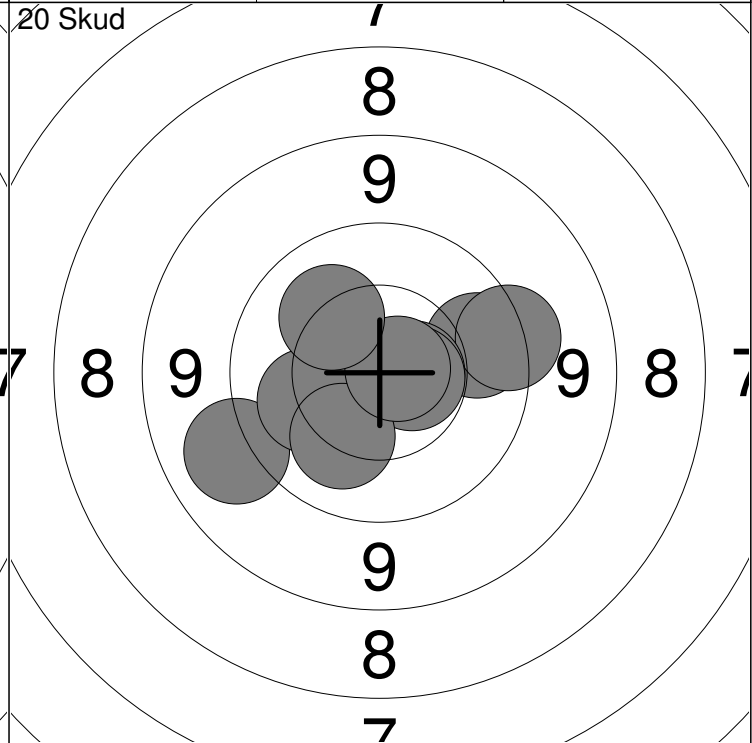
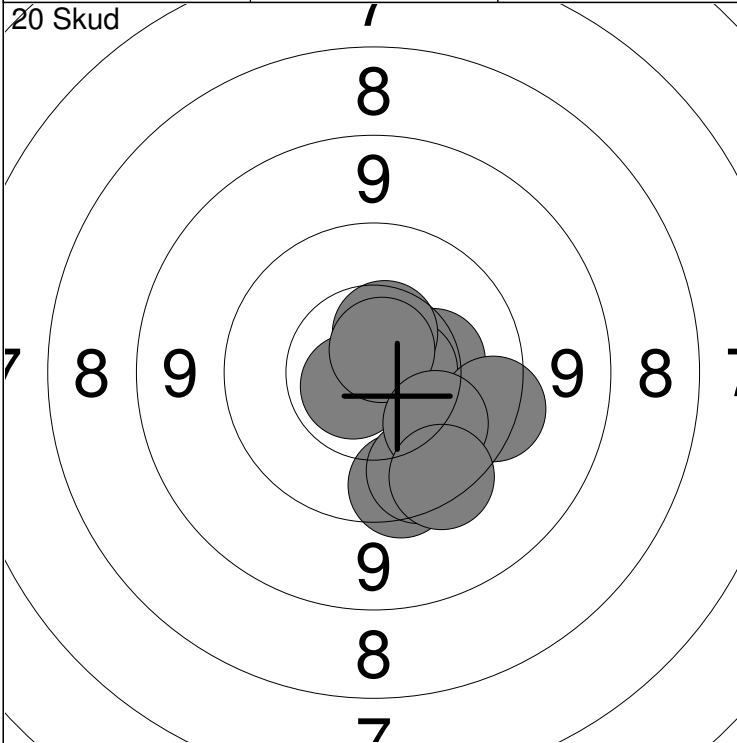

1: 10.3 →	6: 10.7x ↗	Serie 96
2: 10.6x →	7: 9.7 ↘	
3: 10.7x ↙	8: 9.8 ↘	Total 96
4: 10.5 ↗	9: 10.1 ↘	
5: 9.6 →	10: 9.6 ↘	

11: 9.9 →	16: 10.6x →	Serie 97
12: 9.5 →	17: 10.6x →	
13: 9.2 ↙	18: 10.2 ↘	Total 193
14: 10.6 ↙	19: 10.8x →	
15: 10.2 ↙	20: 10.2 ↙	

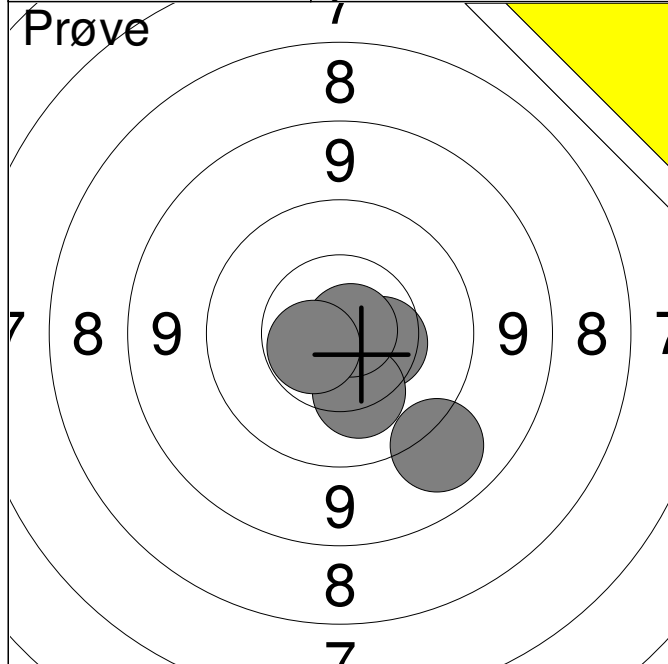

1:	10.6x	↘
2:	10.5	→
3:	10.2	↘
4:	9.2	↘
5:	10.8x	→
6:	10.6x	↙
<b>Serie</b>		<b>59.0</b>
<b>Total</b>		<b>0.0</b>

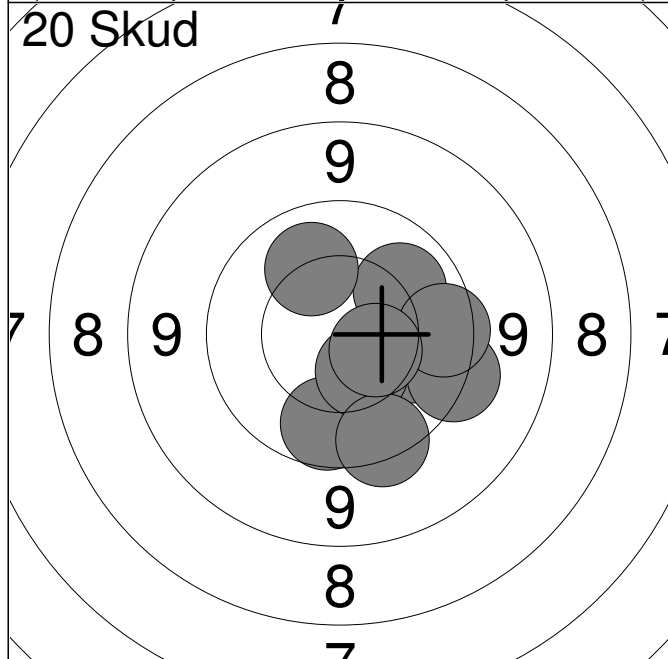

1:	10.0	→
2:	10.1	↗
3:	10.1	↗
4:	10.1	↘
5:	9.9	↘
6:	9.5	↘
7:	10.4	↘
8:	9.6	↘
9:	9.7	→
10:	10.5	↘
<b>Serie</b>		<b>96.0</b>
<b>Total</b>		<b>96.0</b>

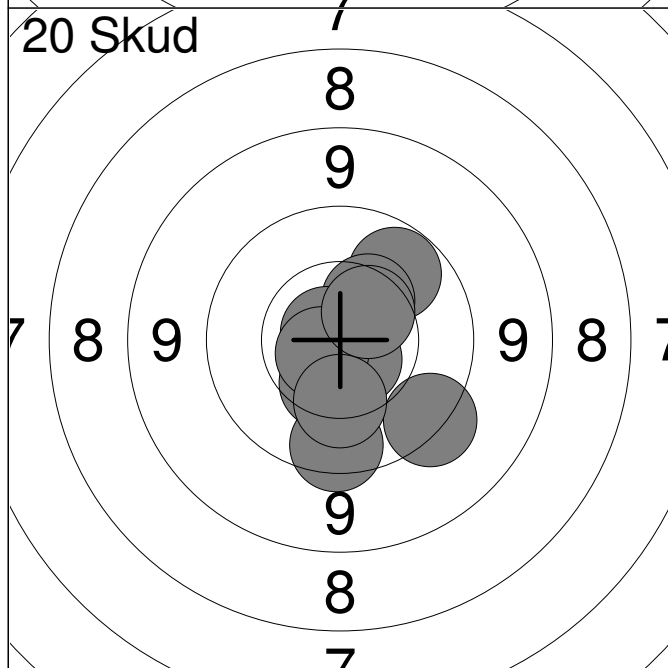

11:	10.0	↗
12:	9.5	↘
13:	10.4	↗
14:	10.8x	↗
15:	10.4	↘
16:	9.7	↘
17:	10.7x	↘
18:	10.7x	↙
19:	10.2	↘
20:	10.5	↗
<b>Serie</b>		<b>98.0</b>
<b>Total</b>		<b>194.0</b>

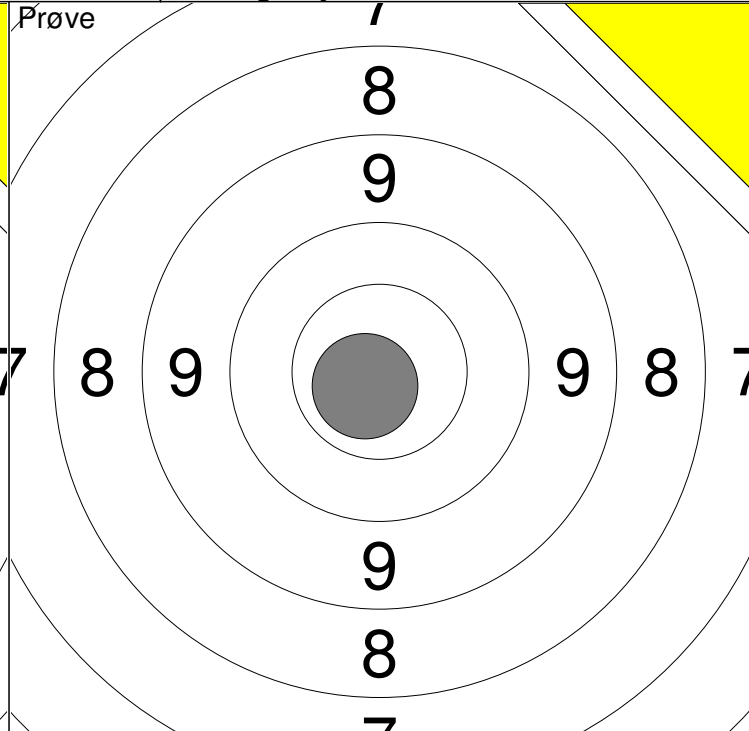
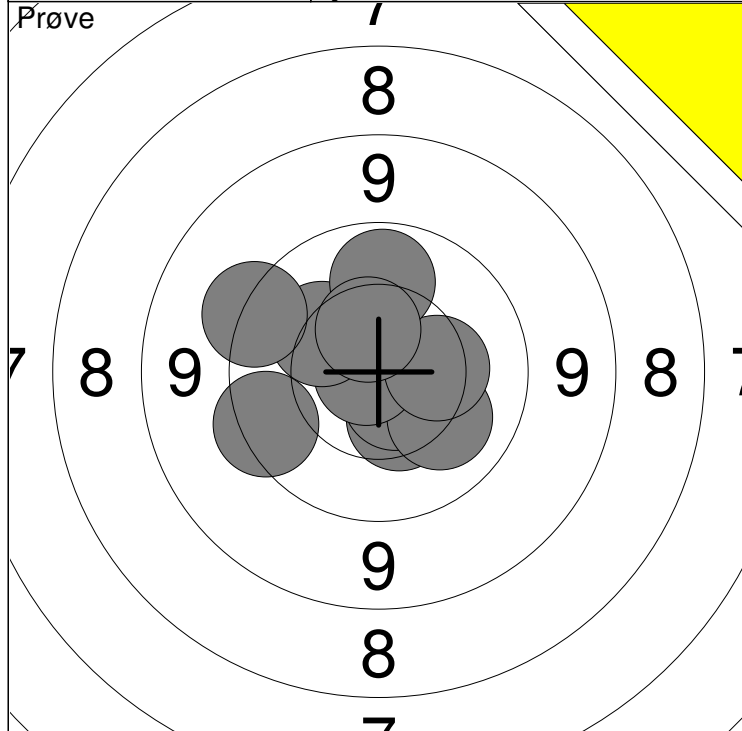

1: 10.4 ↘	6: 9.6 ←	Serie	98
2: 10.6x ↘	7: 10.2 ↗		
3: 10.2 ↘	8: 10.0 ↑	Total	0
4: 10.8x ←	9: 9.5 ↖		
5: 10.3 →	10: 10.5 ↑		

11: 10.7x ↙	Serie	10
	Total	0

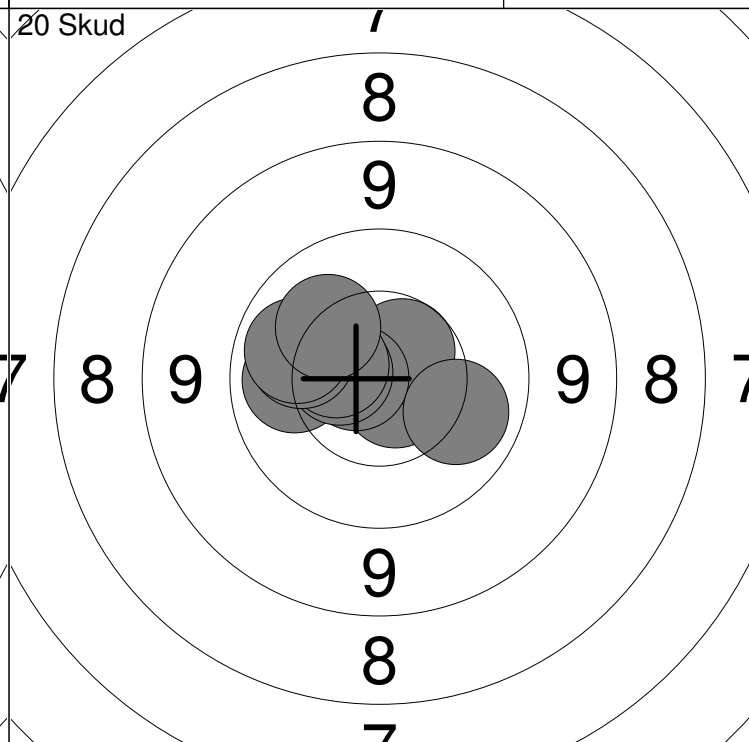
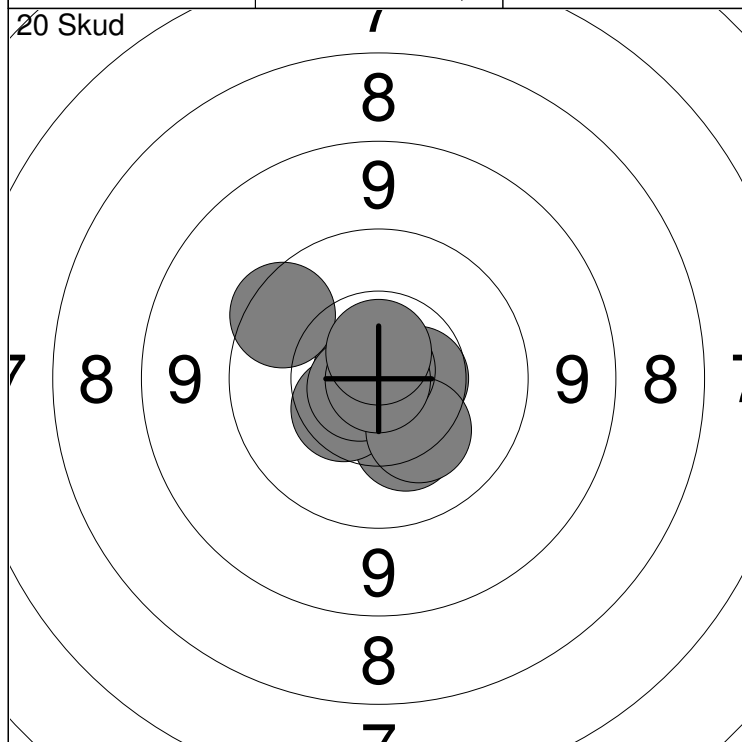

1: 10.3 ↘	6: 10.3 ↘	Serie	99
2: 10.8x ↖	7: 9.7 ↗		
3: 10.5 ↖	8: 10.9x ↗	Total	99
4: 10.6 →	9: 10.9x ↘		
5: 10.7x ↖	10: 10.7x ↑		

11: 10.7x ↘	16: 10.5 ←	Serie	100
12: 10.1 ←	17: 10.1 ←		
13: 10.6 ↗	18: 10.1 ↘	Total	199
14: 10.7x ←	19: 10.1 ←		
15: 10.5 ←	20: 10.2 ↗		

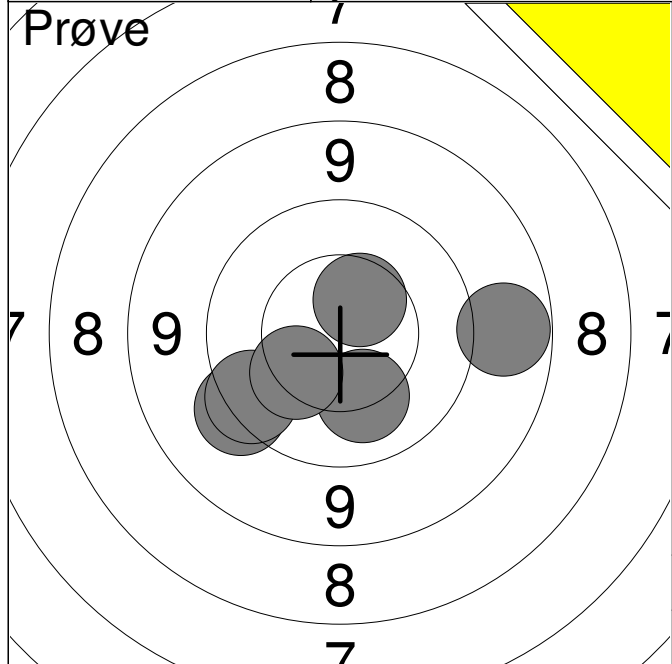

1:	9.5	↙
2:	10.5	↗
3:	9.0	→
4:	9.7	↙
5:	10.2	↘
6:	10.3	↘

<b>Serie</b>	<b>57.0</b>
<b>Total</b>	<b>0.0</b>

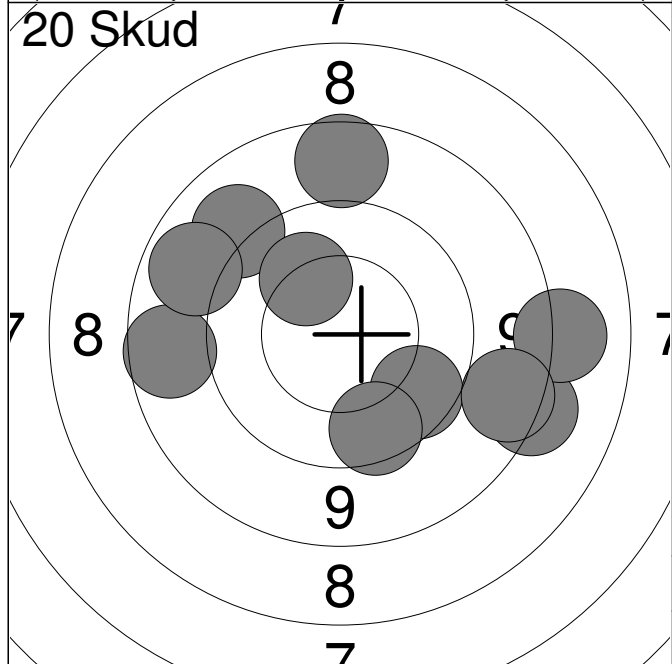

1:	9.8	↘
2:	9.2	↗
3:	8.4	↘
4:	8.9	←
5:	8.3	→
6:	8.8	↘
7:	10.2	↗
8:	8.8	↑
9:	9.0	↗
10:	9.8	↘

<b>Serie</b>	<b>86.0</b>
<b>Total</b>	<b>86.0</b>

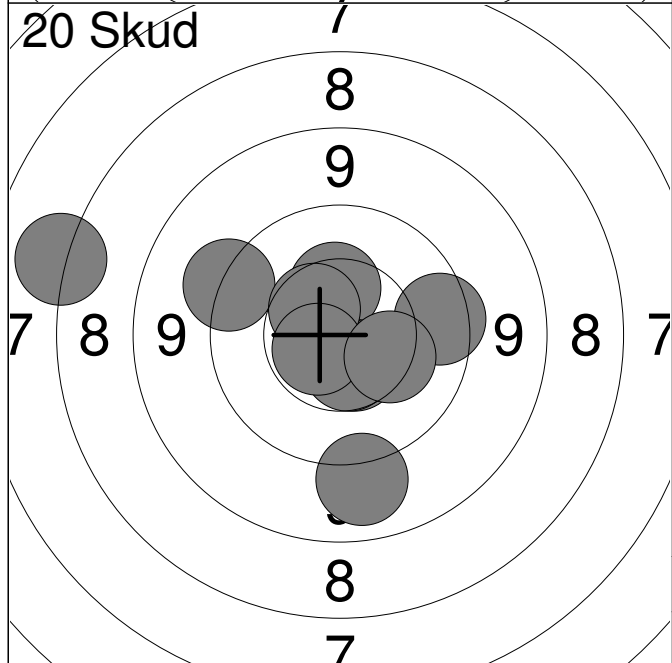

11:	10.4	↑
12:	9.1	↘
13:	7.3	←
14:	9.5	↗
15:	10.6	↘
16:	10.6	↘
17:	10.5	↗
18:	9.7	→
19:	10.6x	↙
20:	10.3	↘

<b>Serie</b>	<b>94.0</b>
<b>Total</b>	<b>180.0</b>

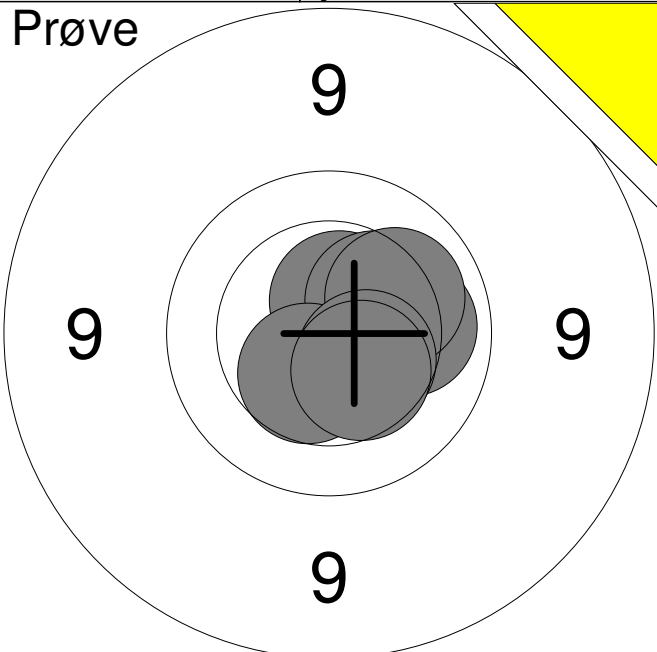
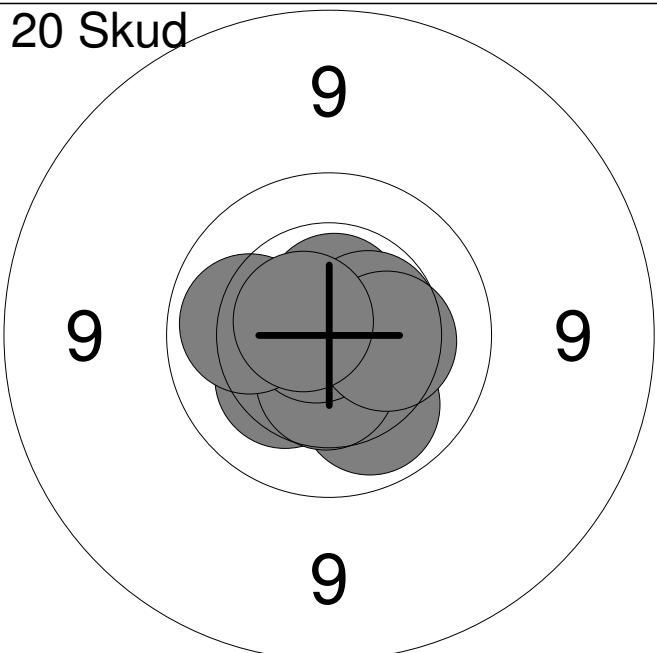
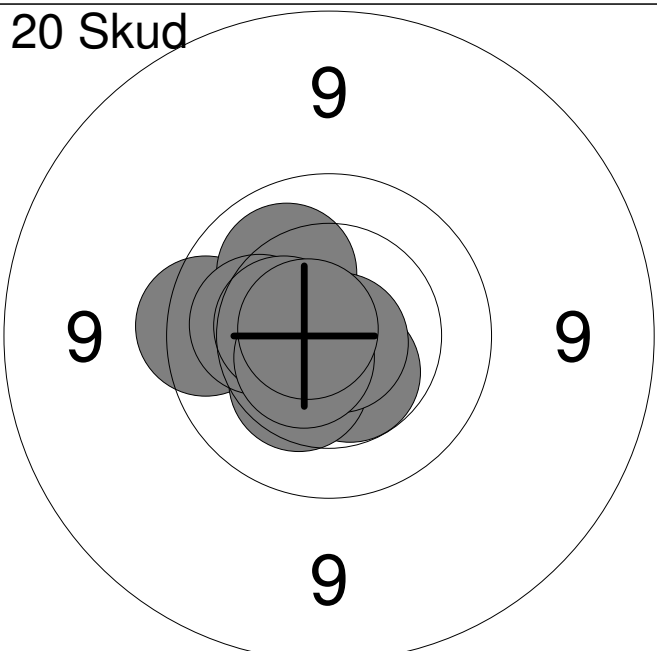
Hold	Skive	Jacob Schultz		
27	9	Aalborg Skyttekreds		BK1
15m	Jyllandsstævne 2015		Aalborg Skyttekreds	
11.02.2015	Jyllandsstævne 2015		Aalborg Skyttekreds	
Prøve		1:	10.1	→
		2:	10.6x	↑
		3:	10.3	↗
		4:	10.5	↘
		5:	10.1	↗
		6:	10.5	↘
		7:	10.4	↘
		Serie		70.0
		Total		0.0
20 Skud		1:	10.1	↘
		2:	10.3	↙
		3:	10.5	↓
		4:	10.9x	↑
		5:	10.8x	←
		6:	10.6x	↑
		7:	10.1	←
		8:	10.5x	→
		9:	10.3	→
		10:	10.6x	↖
		Serie		100.0
		Total		100.0
20 Skud		11:	9.8	←
		12:	10.5x	↘
		13:	10.5x	↗
		14:	10.1	↗
		15:	10.4	↘
		16:	10.8x	↘
		17:	10.2	←
		18:	10.4	←
		19:	10.6x	↙
		20:	10.7x	←
		Serie		99.0
		Total		199.0

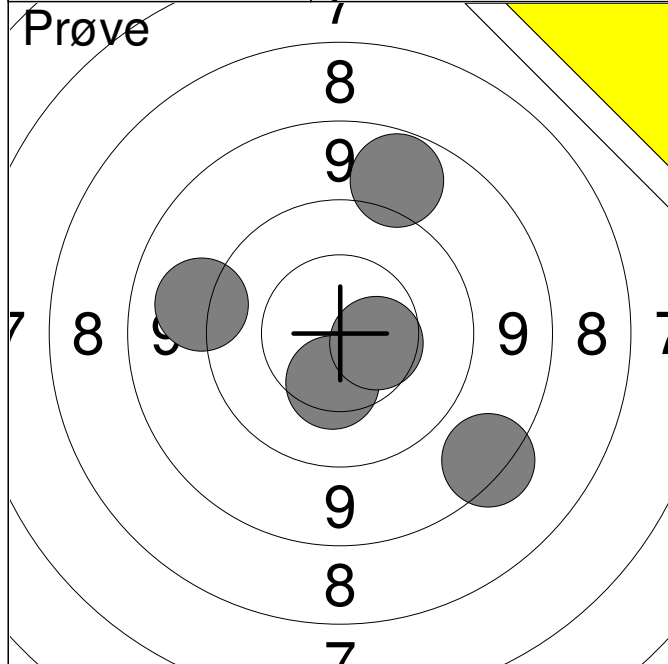

1:	9.3	←
2:	8.6	↘
3:	10.4	↘
4:	9.0	↗
5:	10.5	→
<b>Serie</b>		<b>46.0</b>
<b>Total</b>		<b>0.0</b>

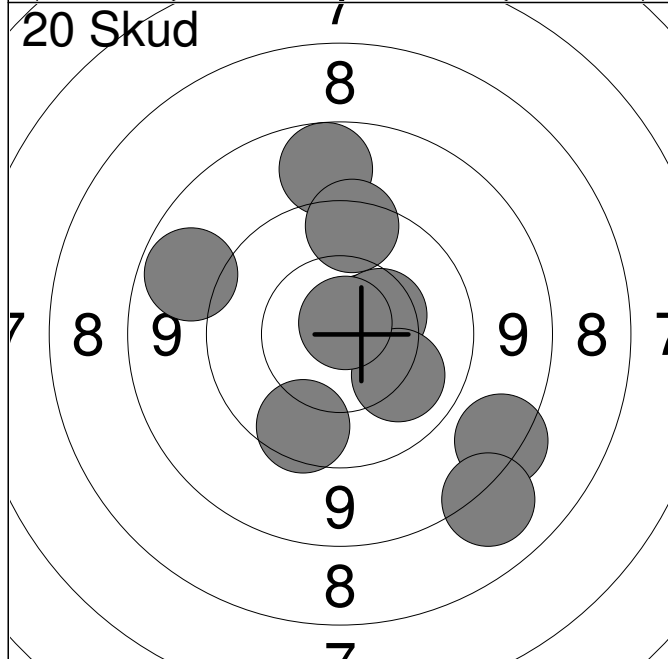

1:	8.6	↘
2:	8.2	↘
3:	9.8	↘
4:	9.0	↑
5:	10.6x	→
6:	9.0	←
7:	10.4	→
8:	10.1	↘
9:	9.7	↑
10:	10.8x	↗
<b>Serie</b>		<b>92.0</b>
<b>Total</b>		<b>92.0</b>

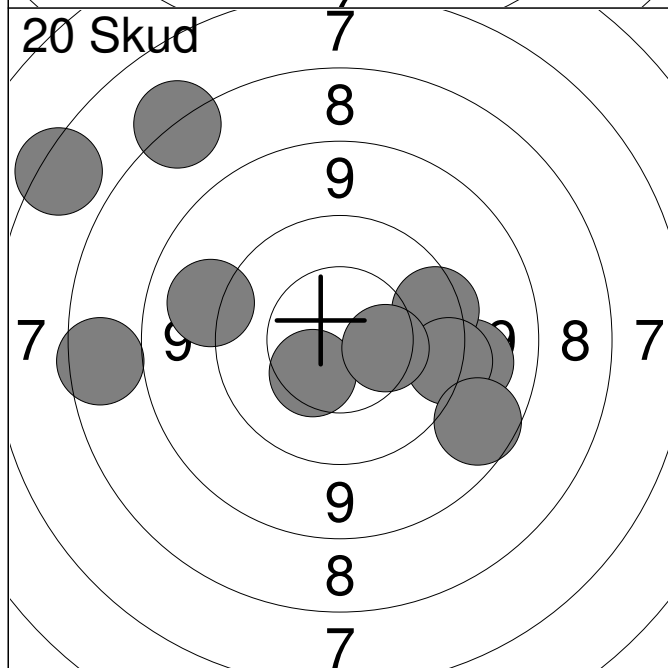

11:	9.2	←
12:	7.8	←
13:	9.3	→
14:	7.4	↗
15:	10.4	↘
16:	9.7	→
17:	9.5	→
18:	8.9	↘
19:	10.4	→
20:	6.6	↗
<b>Serie</b>		<b>84.0</b>
<b>Total</b>		<b>176.0</b>

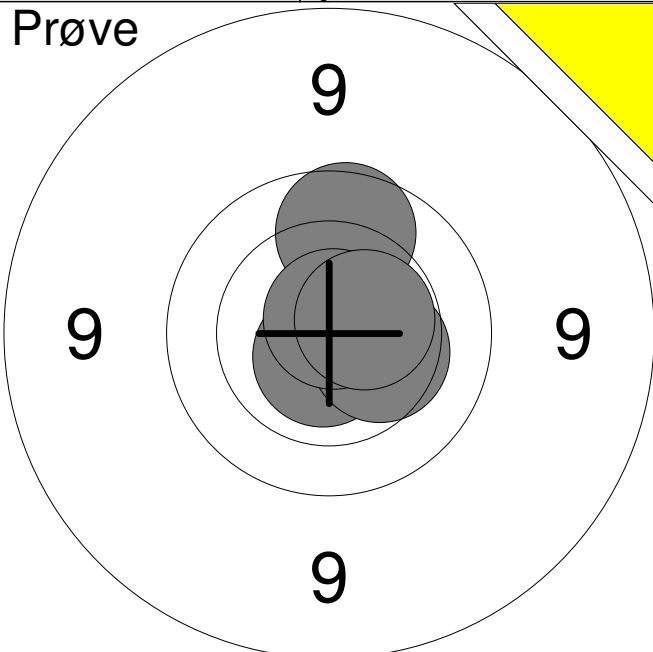
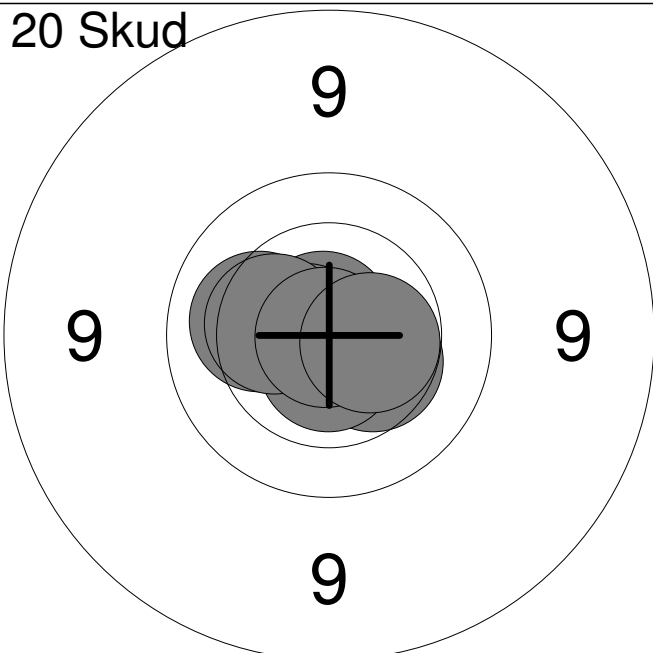
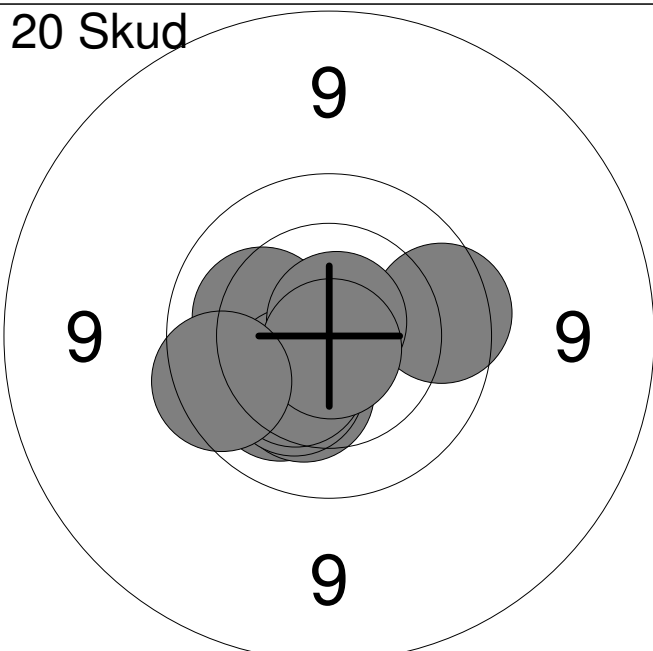
Hold	Skive	Lisbeth Stricker Jensen	
27	11		
15m	Vodskov Skytteforening	MÅ2	
11.02.2015	Jyllandsstævne 2015	Aalborg Skyttekreds	
Prøve		1: 10.7x	↘
		2: 10.4	→
		3: 9.9	↑
		4: 10.8x	↑
		5: 10.5x	→
		<b>Serie</b>	<b>49.0</b>
		<b>Total</b>	<b>0.0</b>
20 Skud		1: 10.4	↘
		2: 10.9x	↘
		3: 10.8x	↑
		4: 10.8x	←
		5: 10.7x	←
		6: 10.7x	↘
		7: 10.2	←
		8: 10.4	←
		9: 10.9x	↙
		10: 10.5x	→
		<b>Serie</b>	<b>100.0</b>
		<b>Total</b>	<b>100.0</b>
20 Skud		11: 10.2	↙
		12: 9.8	→
		13: 10.7x	←
		14: 10.2	←
		15: 10.3	↘
		16: 10.3	↙
		17: 10.4	↙
		18: 10.8x	↗
		19: 10.8x	↘
		20: 9.8	←
		<b>Serie</b>	<b>98.0</b>
		<b>Total</b>	<b>198.0</b>

Hold <b>27</b>	Skive <b>12</b>	<b>Jørgen Sloth Borregaard</b>	
-------------------	--------------------	--------------------------------	--

15m	Mou & Omegns Skf.	MÅ2
-----	-------------------	-----

11.02.2015	Jyllandsstævne 2015	Aalborg Skyttekreds
------------	---------------------	---------------------

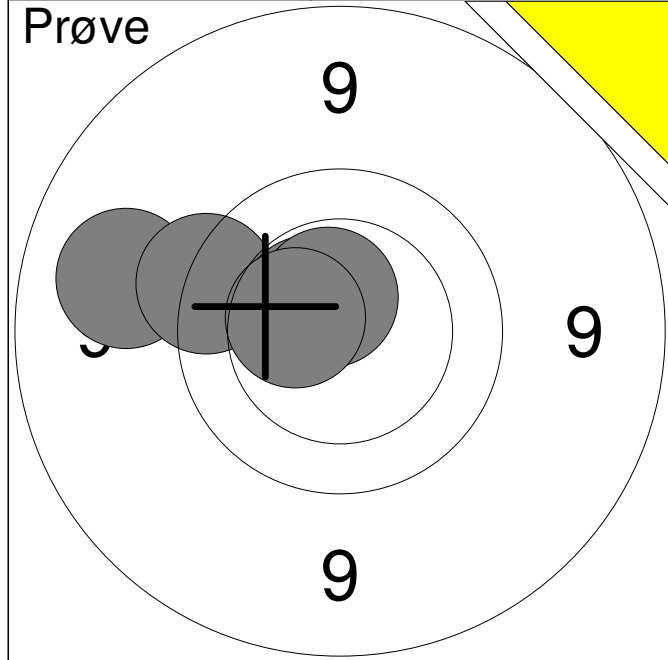

1:	9.2	↖
2:	9.6	↖
3:	10.5x	↗
4:	10.6x	↗
5:	10.4	↖
<b>Serie</b>		<b>48.0</b>
<b>Total</b>		<b>0.0</b>

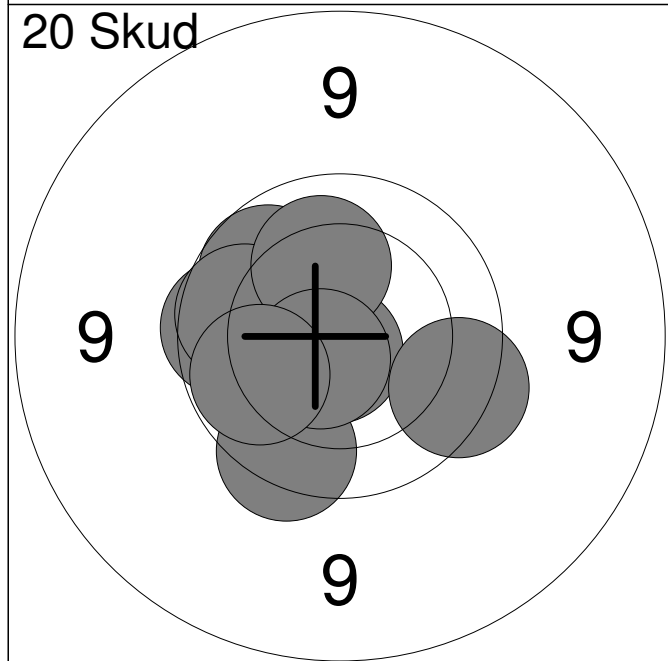

1:	10.7x	↘
2:	10.4	↖
3:	9.9	↗
4:	9.8	↖
5:	9.7	↘
6:	9.7	↘
7:	9.9	↖
8:	10.2	↗
9:	10.6x	↘
10:	10.0	↖
<b>Serie</b>		<b>95.0</b>
<b>Total</b>		<b>95.0</b>

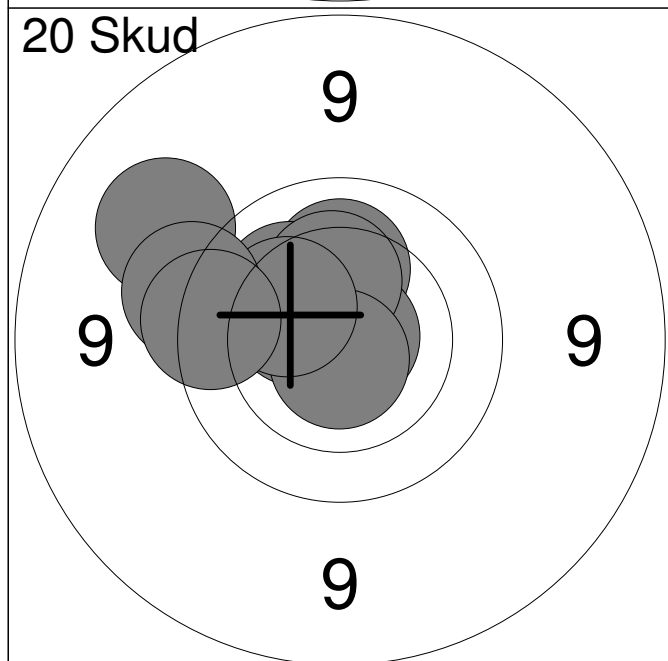

11:	10.2	↗
12:	9.2	↗
13:	10.4	↗
14:	10.2	↗
15:	10.8x	↗
16:	10.3	↗
17:	10.7x	↘
18:	10.3	↗
19:	9.6	↖
20:	9.7	↖
<b>Serie</b>		<b>97.0</b>
<b>Total</b>		<b>192.0</b>



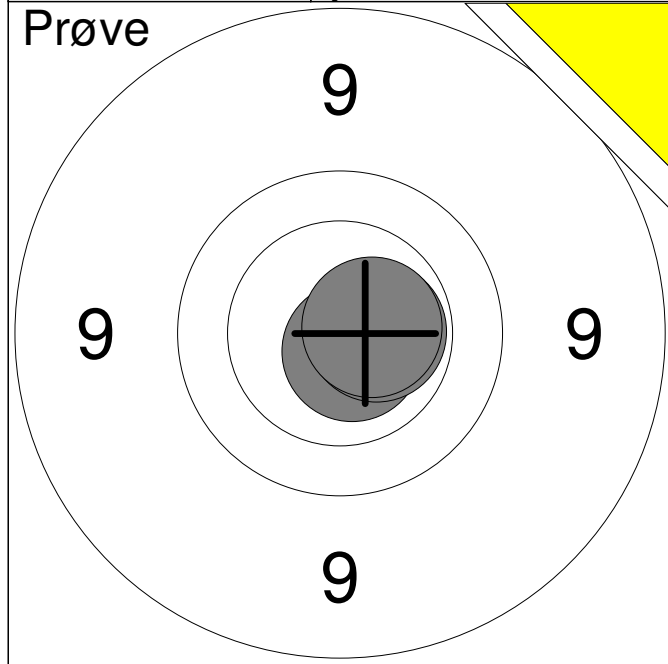

1:	10.7x	↘
2:	10.6x	→
3:	10.6x	→
<b>Serie</b>		<b>30.0</b>
<b>Total</b>		<b>0.0</b>

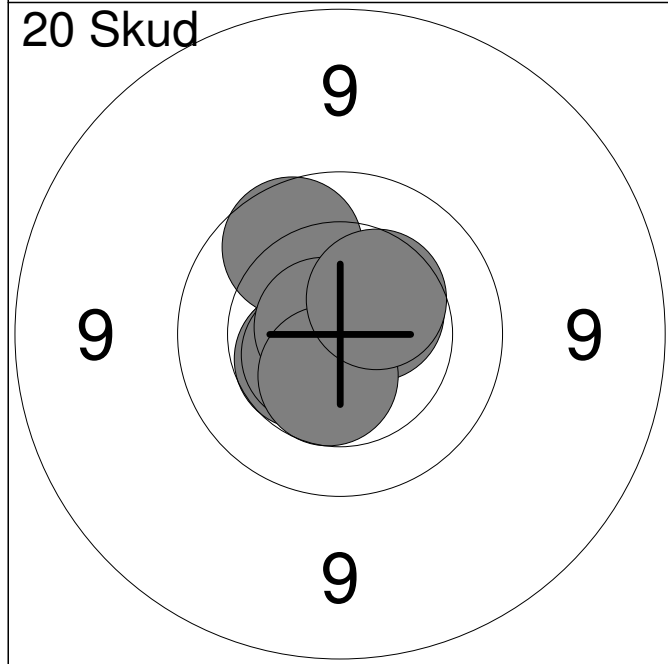

1:	10.5	↙
2:	10.8x	↖
3:	10.5	↙
4:	10.6x	↙
5:	10.5x	↗
6:	10.5x	↗
7:	9.9	↗
8:	10.8x	↖
9:	10.5	↘
10:	10.4	↗
<b>Serie</b>		<b>99.0</b>
<b>Total</b>		<b>99.0</b>

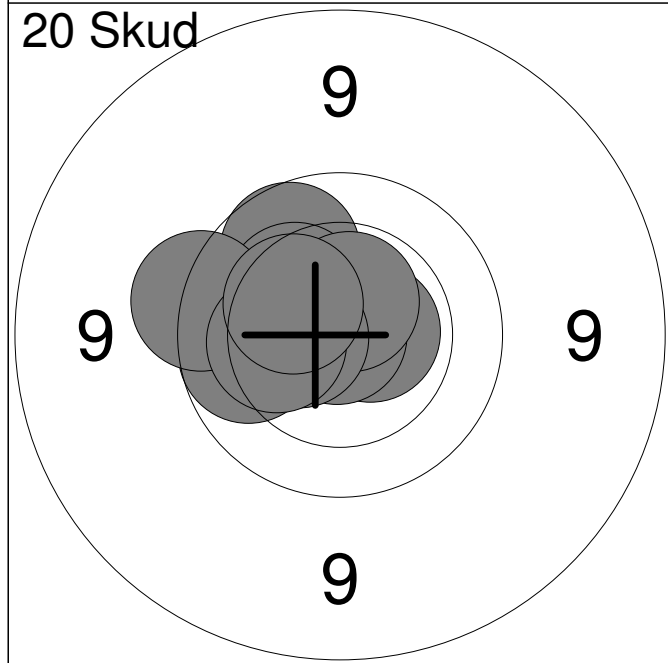

11:	9.9	↗
12:	9.9	↙
13:	10.6x	→
14:	10.9x	↙
15:	10.3	↗
16:	10.6x	↗
17:	10.5x	↙
18:	9.6	↙
19:	10.3	↙
20:	10.3	↗
<b>Serie</b>		<b>97.0</b>
<b>Total</b>		<b>196.0</b>

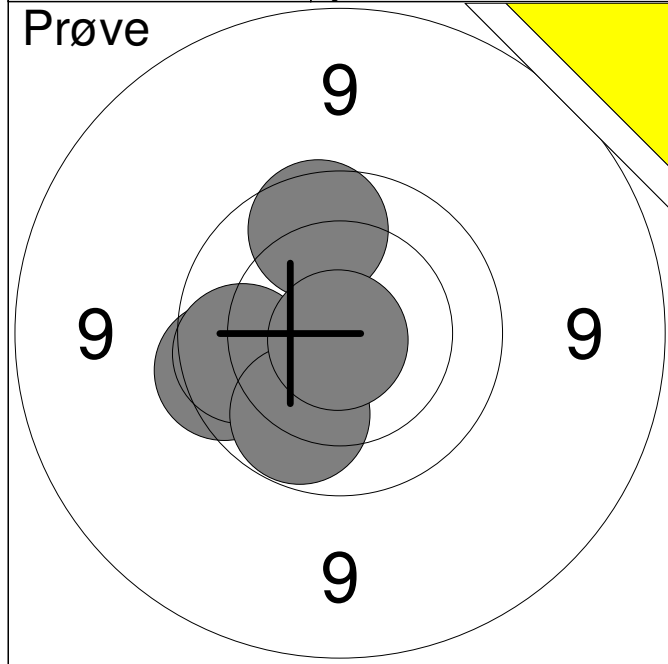

1:	9.8	←
2:	9.9	↑
3:	9.9	←
4:	10.0	↓
5:	10.9x	↓
<b>Serie</b>		<b>47.0</b>
<b>Total</b>		<b>0.0</b>

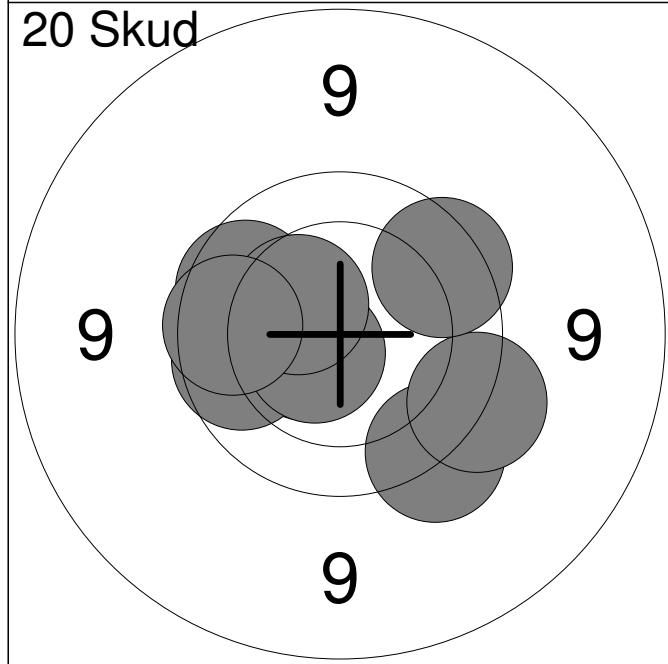

1:	10.3	↗
2:	9.9	↗
3:	10.6x	←
4:	9.9	←
5:	10.6x	↓
6:	9.6	↓
7:	10.4	↗
8:	9.6	↓
9:	9.9	←
10:	9.8	↗
<b>Serie</b>		<b>94.0</b>
<b>Total</b>		<b>94.0</b>

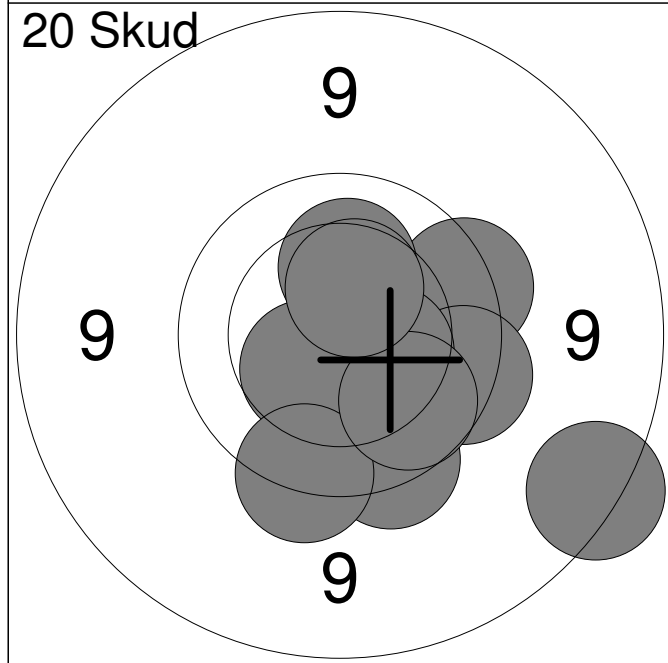

11:	9.7	→
12:	10.2	↑
13:	9.7	→
14:	10.4	→
15:	10.5	↓
16:	9.7	↓
17:	8.8	↓
18:	9.6	↓
19:	9.9	↓
20:	10.4	↑
<b>Serie</b>		<b>93.0</b>
<b>Total</b>		<b>187.0</b>

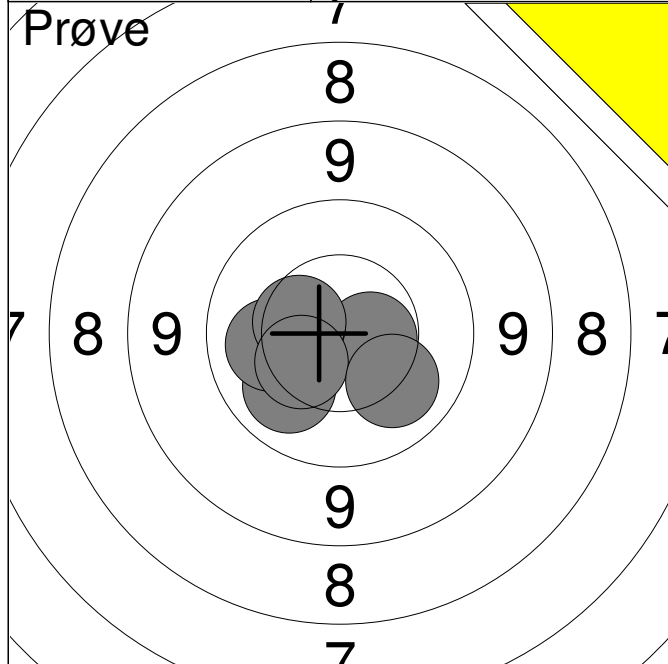

1:	10.6x	→
2:	10.2	←
3:	10.5	←
4:	10.1	↙
5:	10.2	←
6:	10.5	←
7:	10.4	↙
8:	10.1	↘
<b>Serie</b>		<b>80.0</b>
<b>Total</b>		<b>0.0</b>

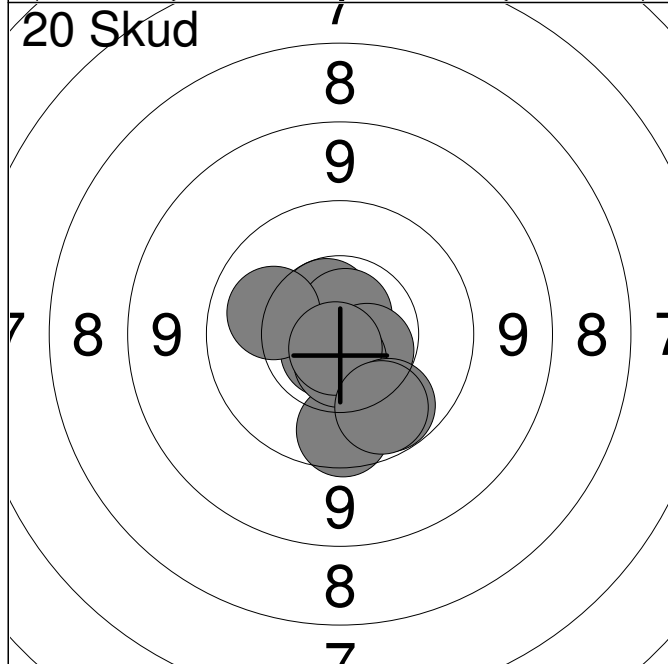

1:	10.6x	↖
2:	10.7x	↖
3:	9.8	↘
4:	10.7x	↙
5:	10.6x	↘
6:	10.6x	↘
7:	10.1	↖
8:	10.8x	↘
9:	10.0	↘
10:	10.0	↘
<b>Serie</b>		<b>99.0</b>
<b>Total</b>		<b>99.0</b>

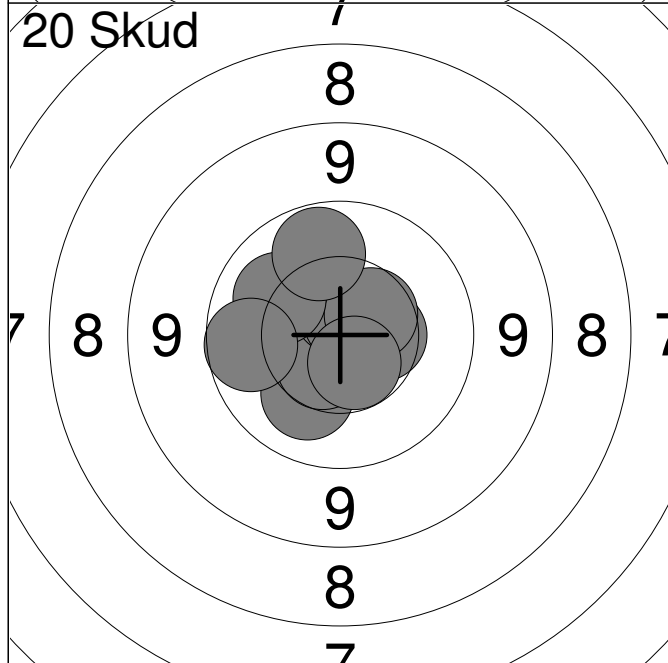

11:	10.2	↙
12:	10.6	↙
13:	10.5	→
14:	10.6x	↑
15:	10.7x	↗
16:	10.5	↗
17:	10.1	↗
18:	10.6x	↘
19:	10.0	↖
20:	9.9	←
<b>Serie</b>		<b>99.0</b>
<b>Total</b>		<b>198.0</b>

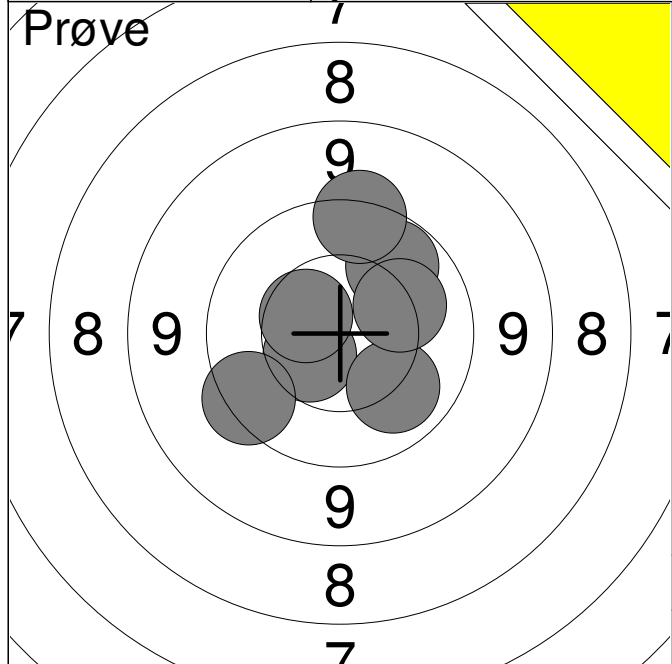

1:	10.5	↙
2:	9.6	↙
3:	10.1	↘
4:	10.5	↖
5:	10.0	↗
6:	9.5	↑
7:	10.2	↗
<b>Serie</b>		<b>68.0</b>
<b>Total</b>		<b>0.0</b>

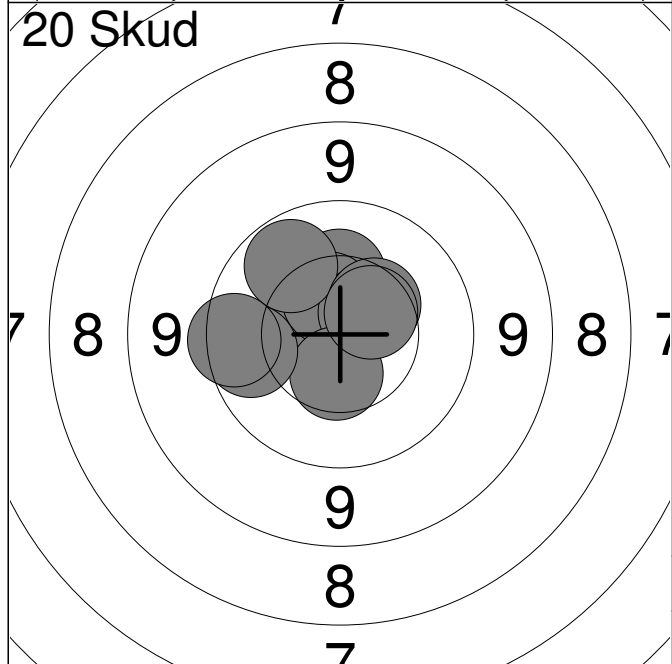

1:	10.6x	↖
2:	10.3	↑
3:	10.5	↑
4:	10.6	↗
5:	10.0	↖
6:	10.4	↗
7:	10.5	↓
8:	10.5	↗
9:	9.9	←
10:	9.7	←
<b>Serie</b>		<b>98.0</b>
<b>Total</b>		<b>98.0</b>

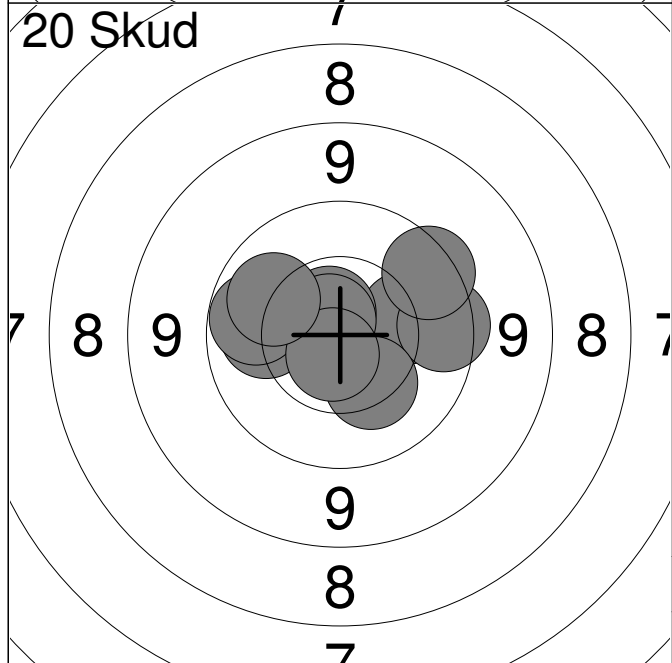

11:	10.1	←
12:	10.2	→
13:	10.0	←
14:	9.7	→
15:	10.3	↘
16:	10.7x	↗
17:	10.7x	↗
18:	10.7x	↘
19:	10.1	↖
20:	9.7	↗
<b>Serie</b>		<b>98.0</b>
<b>Total</b>		<b>196.0</b>

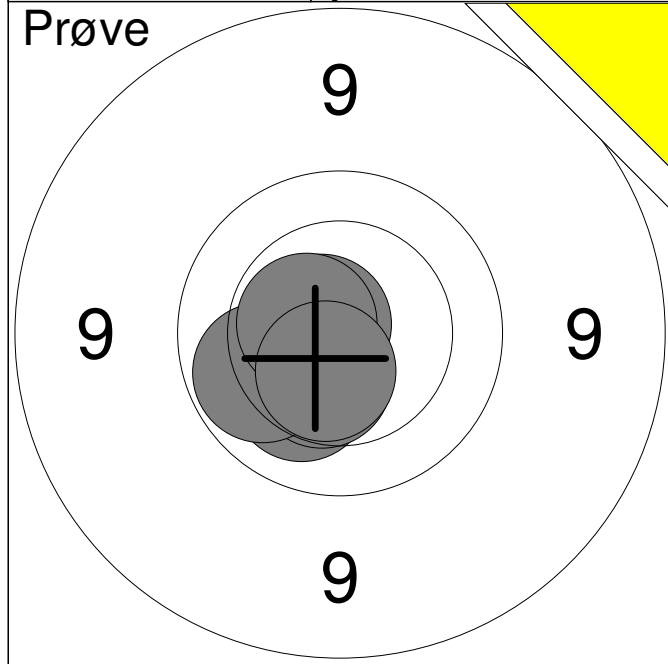

1:	10.2	↙
2:	10.4	↙
3:	10.3	↙
4:	10.0	↙
5:	10.7x	↗
6:	10.6x	↖
7:	10.5x	↙
<b>Serie</b>	<b>70.0</b>	
<b>Total</b>	<b>0.0</b>	

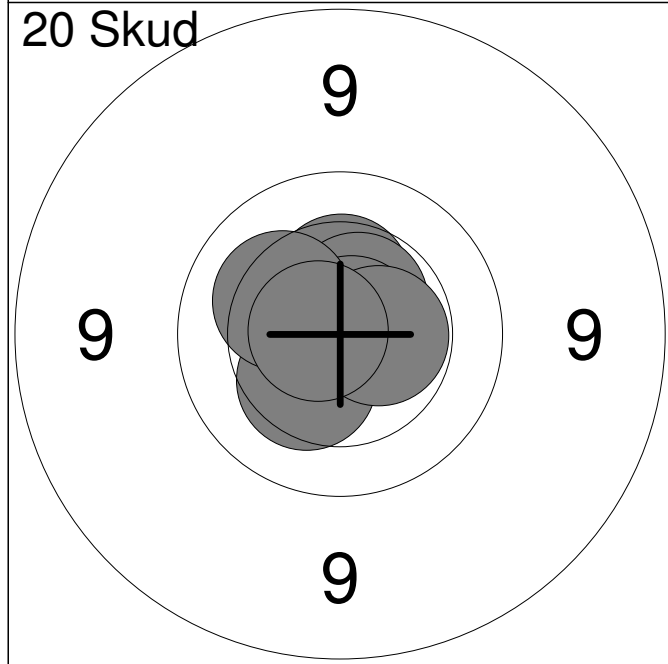

1:	10.8x	→
2:	10.7x	↑
3:	10.5	↑
4:	10.4	↑
5:	10.6x	↗
6:	10.3	↙
7:	10.8x	↗
8:	10.5x	→
9:	10.2	↖
10:	10.7x	←
<b>Serie</b>	<b>100.0</b>	
<b>Total</b>	<b>100.0</b>	

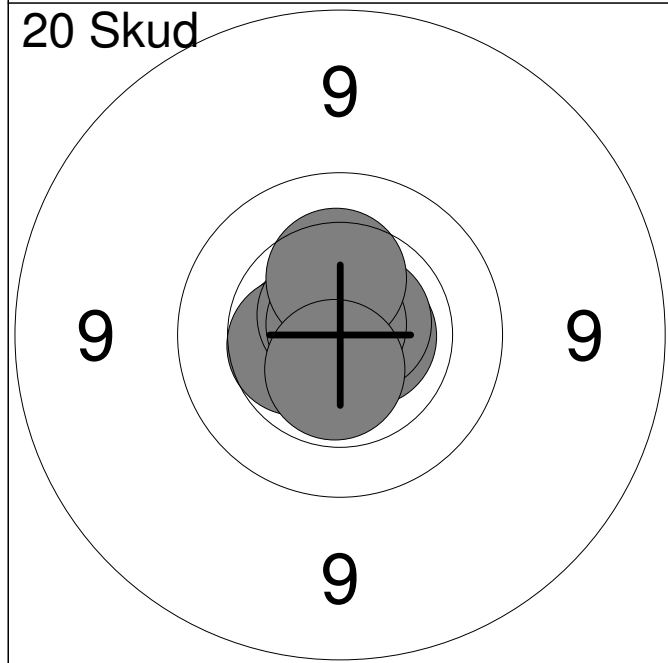

11:	10.9x	↙
12:	10.6x	←
13:	10.5	←
14:	10.9x	→
15:	10.7x	→
16:	10.7x	↗
17:	10.7x	↗
18:	10.8x	↗
19:	10.3	↑
20:	10.6x	↓
<b>Serie</b>	<b>100.0</b>	
<b>Total</b>	<b>200.0</b>	

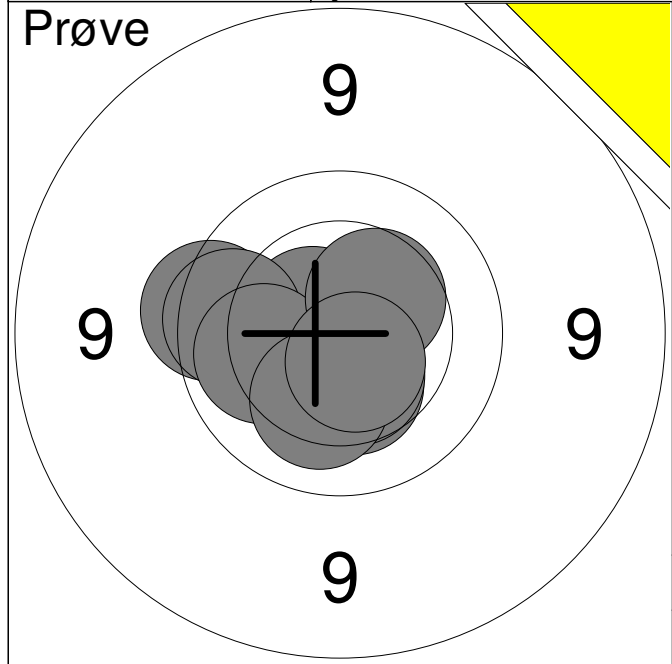

1:	10.4	↙
2:	10.6x	↗
3:	9.7	←
4:	9.9	←
5:	10.4	↘
6:	10.5	↘
7:	10.1	←
8:	10.4	↗
9:	10.2	↘
10:	10.6x	↘
<b>Serie</b>		<b>98.0</b>
<b>Total</b>		<b>0.0</b>

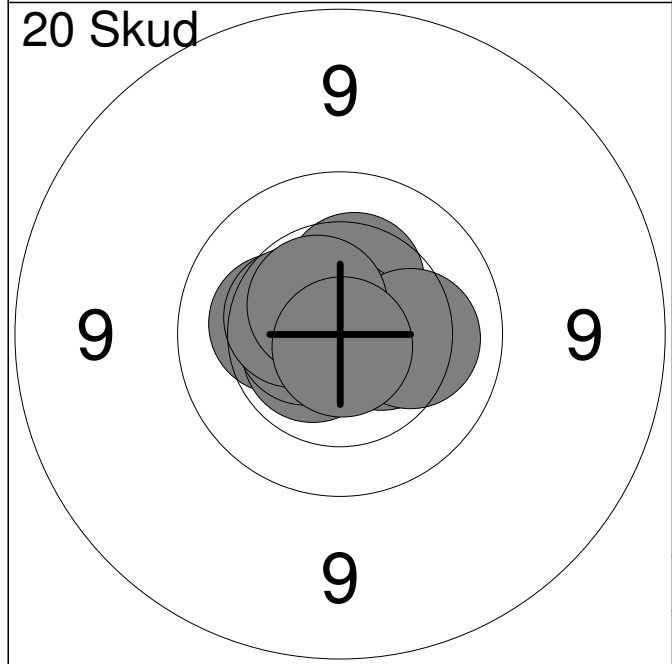

1:	10.3	←
2:	10.5x	→
3:	10.6x	↙
4:	10.4	↑
5:	10.6x	←
6:	10.9x	↑
7:	10.4	↖
8:	10.2	→
9:	10.6x	↗
10:	10.8x	↘
<b>Serie</b>		<b>100.0</b>
<b>Total</b>		<b>100.0</b>

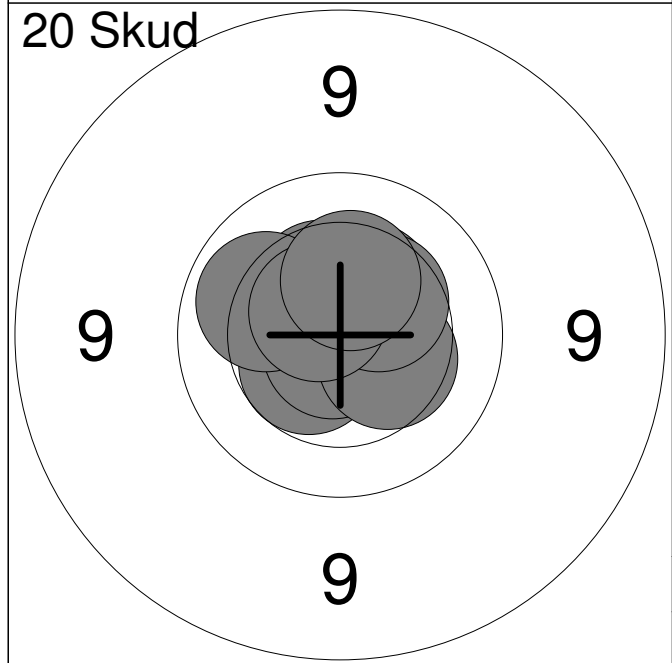

11:	10.6x	↘
12:	10.5	↙
13:	10.4	↗
14:	10.8x	↙
15:	10.4	↗
16:	10.4	↘
17:	10.1	↖
18:	10.4	↗
19:	10.6x	↗
20:	10.4	↑
<b>Serie</b>		<b>100.0</b>
<b>Total</b>		<b>200.0</b>

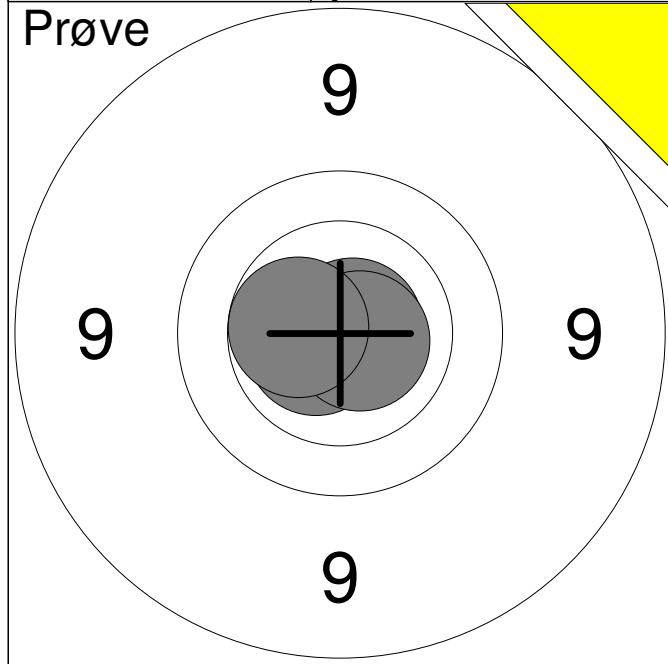

1:	10.8x	→
2:	10.7x	↙
3:	10.7x	→
4:	10.5x	↙
<b>Serie</b>		<b>40.0</b>
<b>Total</b>		<b>0.0</b>

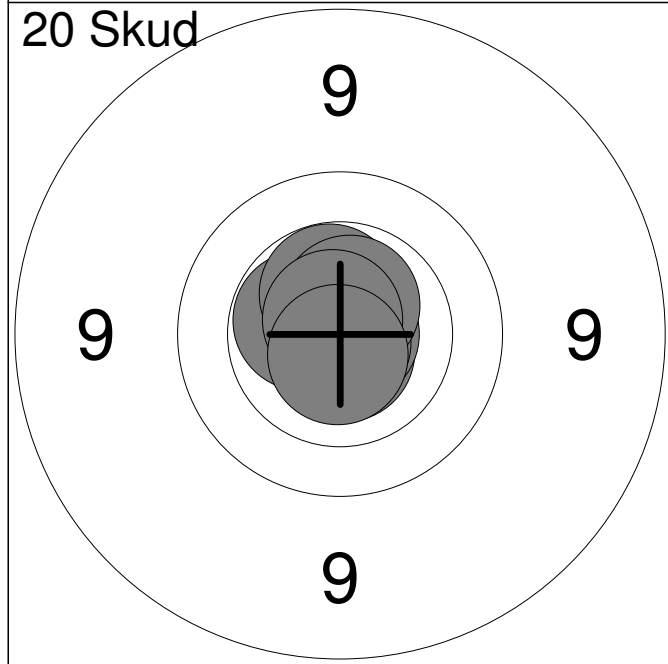

1:	10.9x	↗
2:	10.5x	↙
3:	10.8x	↓
4:	10.9x	→
5:	10.5x	↑
6:	10.9x	↓
7:	10.8x	↑
8:	10.6x	↑
9:	10.8x	↑
10:	10.7x	↓
<b>Serie</b>		<b>100.0</b>
<b>Total</b>		<b>100.0</b>

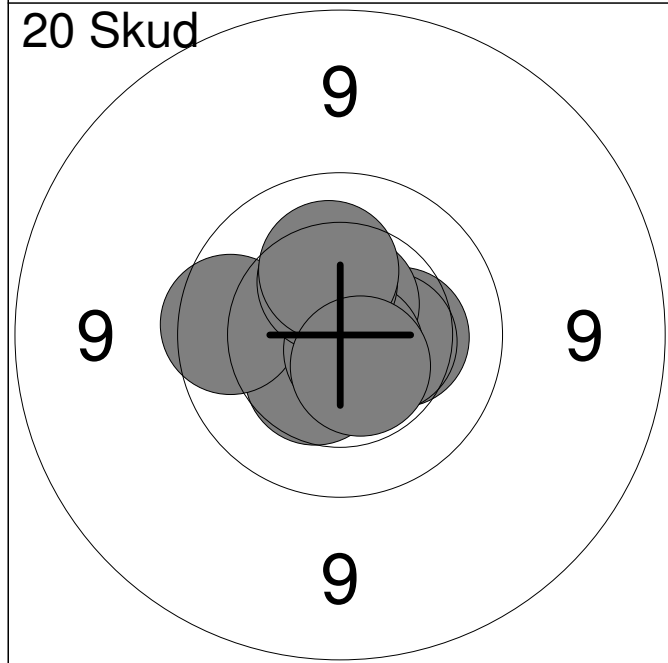

11:	10.3	→
12:	10.9x	↗
13:	10.4	↙
14:	10.4	→
15:	10.6x	↑
16:	9.8	↙
17:	10.7x	↙
18:	10.4	↑
19:	10.2	↑
20:	10.5x	↓
<b>Serie</b>		<b>99.0</b>
<b>Total</b>		<b>199.0</b>

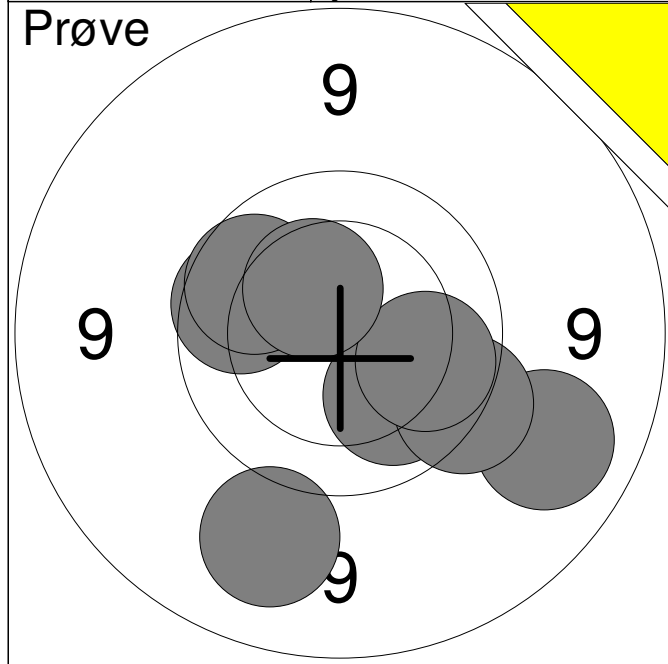

1:	10.1	↘
2:	9.2	↙
3:	9.9	↗
4:	9.9	↗
5:	9.1	↘
6:	9.6	↘
7:	10.0	↘
8:	10.4	↗

Serie	75.0
Total	0.0

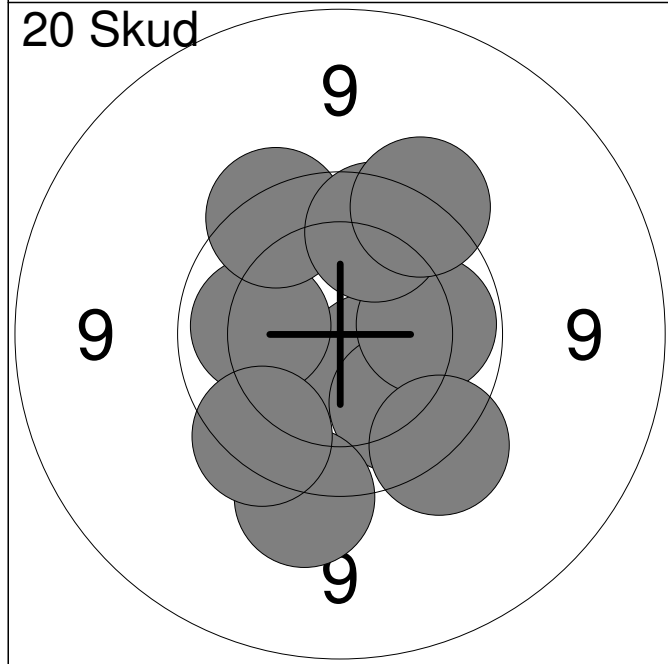

1:	10.5	↘
2:	10.1	↖
3:	10.0	↘
4:	9.5	↘
5:	9.7	↗
6:	10.0	→
7:	9.9	↗
8:	9.6	↗
9:	9.7	↘
10:	9.6	↘

Serie	94.0
Total	94.0

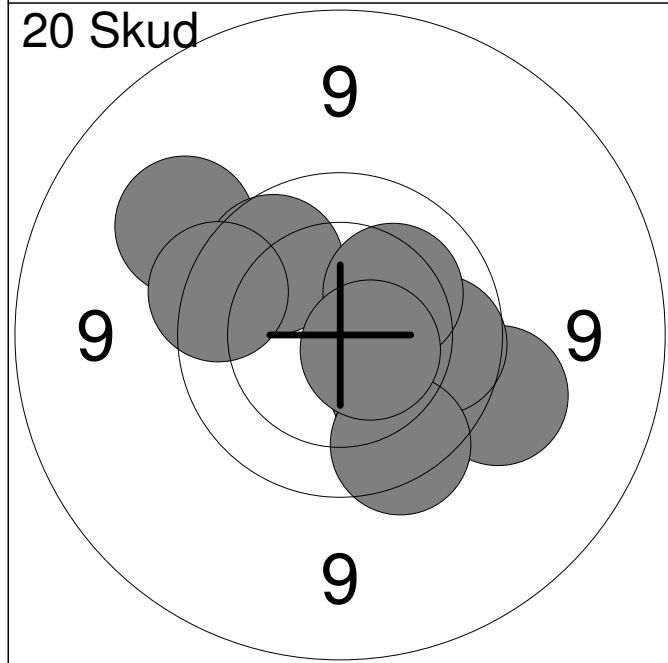

11:	10.1	↘
12:	9.8	↘
13:	9.5	↘
14:	9.9	→
15:	9.4	↗
16:	9.9	↗
17:	10.2	↗
18:	9.7	↘
19:	9.7	↗
20:	10.6x	↘

Serie	93.0
Total	187.0



Hold	Skive	Thomas Grøn Bendixen		
29	1	Hjørring Skytteforening	MB1	
15m		Jyllandsstævne 2015	Aalborg Skyttekreds	
11.02.2015				
Prøve		1:	10.2	↑
		2:	10.7x	→
		3:	10.4	↑
		4:	10.5x	↓
		5:	10.6x	→
		6:	10.1	↙
		7:	9.9	↓
		8:	10.6x	↑
		9:	10.8x	→
		Serie		
Total			0.0	
20 Skud		1:	10.7x	↑
		2:	10.7x	↙
		3:	10.4	↓
		4:	10.7x	↙
		5:	10.6x	↓
		6:	10.5x	↗
		7:	10.7x	↗
		8:	10.5	↙
		9:	10.6x	↙
		10:	10.0	↓
Serie			100.0	
Total			100.0	
20 Skud		11:	9.9	↙
		12:	10.4	↗
		13:	10.6x	↑
		14:	10.8x	→
		15:	10.7x	↓
		16:	10.8x	↗
		17:	10.9x	↙
		18:	10.7x	↗
		19:	10.4	↓
		20:	10.4	↗
Serie			99.0	
Total			199.0	

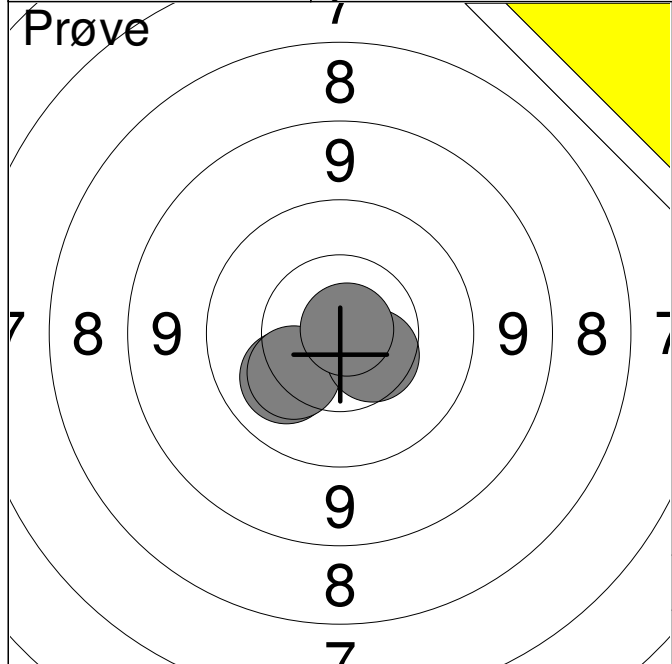

1:	10.1	↙
2:	10.2	↙
3:	10.5	↘
4:	10.9x	→
<b>Serie</b>		<b>40.0</b>
<b>Total</b>		<b>0.0</b>

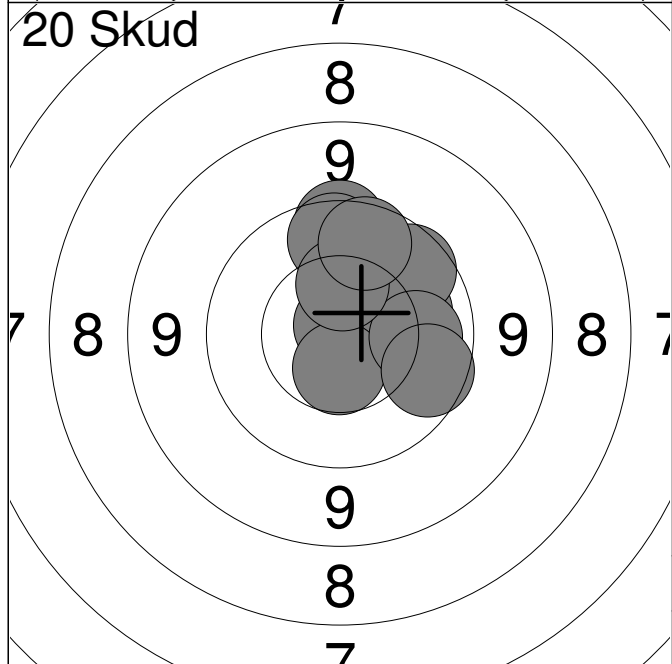

1:	10.2	→
2:	10.8x	↑
3:	10.6	↓
4:	9.8	↗
5:	10.1	→
6:	9.7	↑
7:	9.8	↘
8:	9.8	↑
9:	10.4	↑
10:	9.8	↑
<b>Serie</b>		<b>95.0</b>
<b>Total</b>		<b>95.0</b>

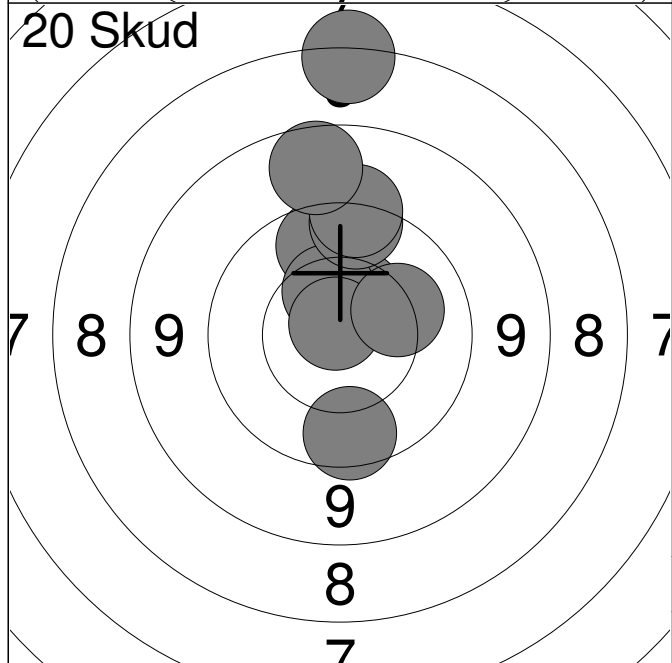

11:	10.5	↑
12:	9.9	↑
13:	10.4	↑
14:	9.6	↑
15:	9.4	↑
16:	7.5	↑
17:	8.9	↑
18:	9.8	↓
19:	10.8x	↖
20:	10.2	→
<b>Serie</b>		<b>91.0</b>
<b>Total</b>		<b>186.0</b>

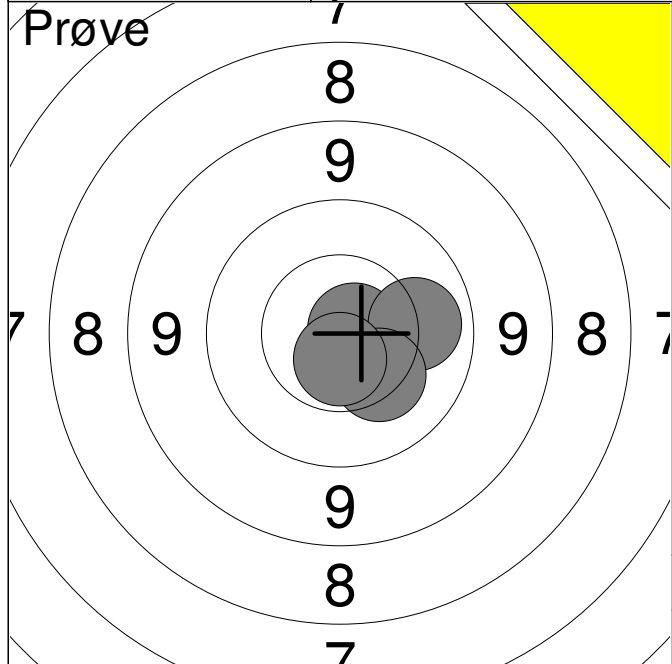

1:	10.5	→
2:	10.8x	→
3:	10.1	→
4:	10.3	↘
5:	10.7x	↓
<b>Serie</b>		<b>50.0</b>
<b>Total</b>		<b>0.0</b>

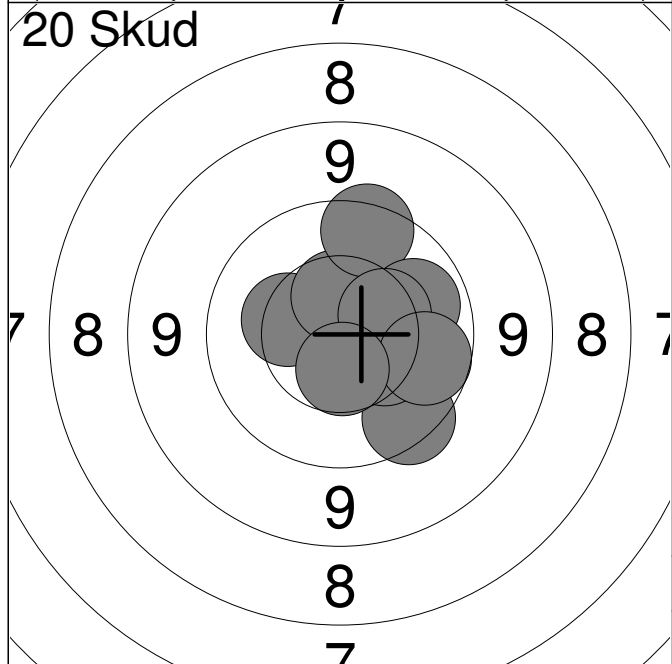

1:	10.3	←
2:	9.7	↘
3:	10.4	→
4:	10.4	↘
5:	10.5	↑
6:	9.7	↑
7:	10.0	→
8:	10.4	→
9:	9.9	→
10:	10.5	↓
<b>Serie</b>		<b>97.0</b>
<b>Total</b>		<b>97.0</b>

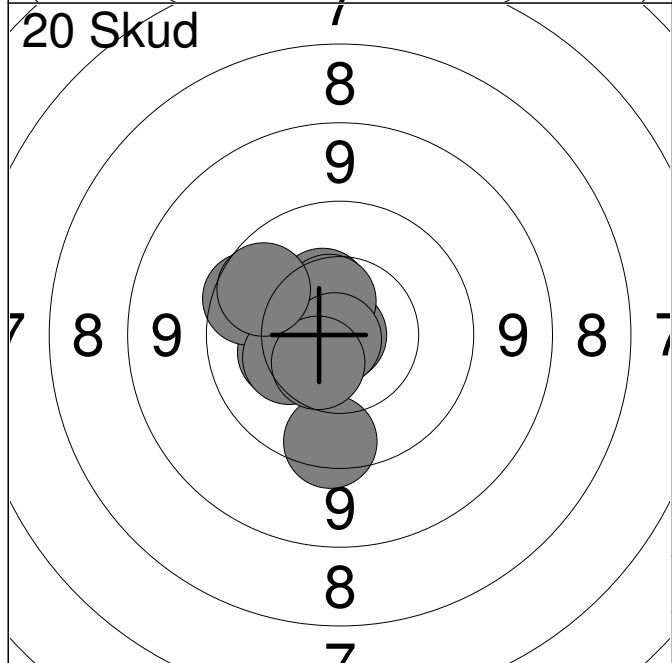

11:	10.3	←
12:	9.7	↓
13:	10.4	↑
14:	10.9x	↗
15:	9.8	←
16:	10.3	←
17:	10.5	↑
18:	10.9x	↘
19:	10.5	↘
20:	9.9	↖
<b>Serie</b>		<b>97.0</b>
<b>Total</b>		<b>194.0</b>

Hold <b>29</b>	Skive <b>5</b>	
-------------------	-------------------	--

15m		
-----	--	--

11.02.2015	Jyllandsstævne 2015	Aalborg Skyttekreds
------------	---------------------	---------------------

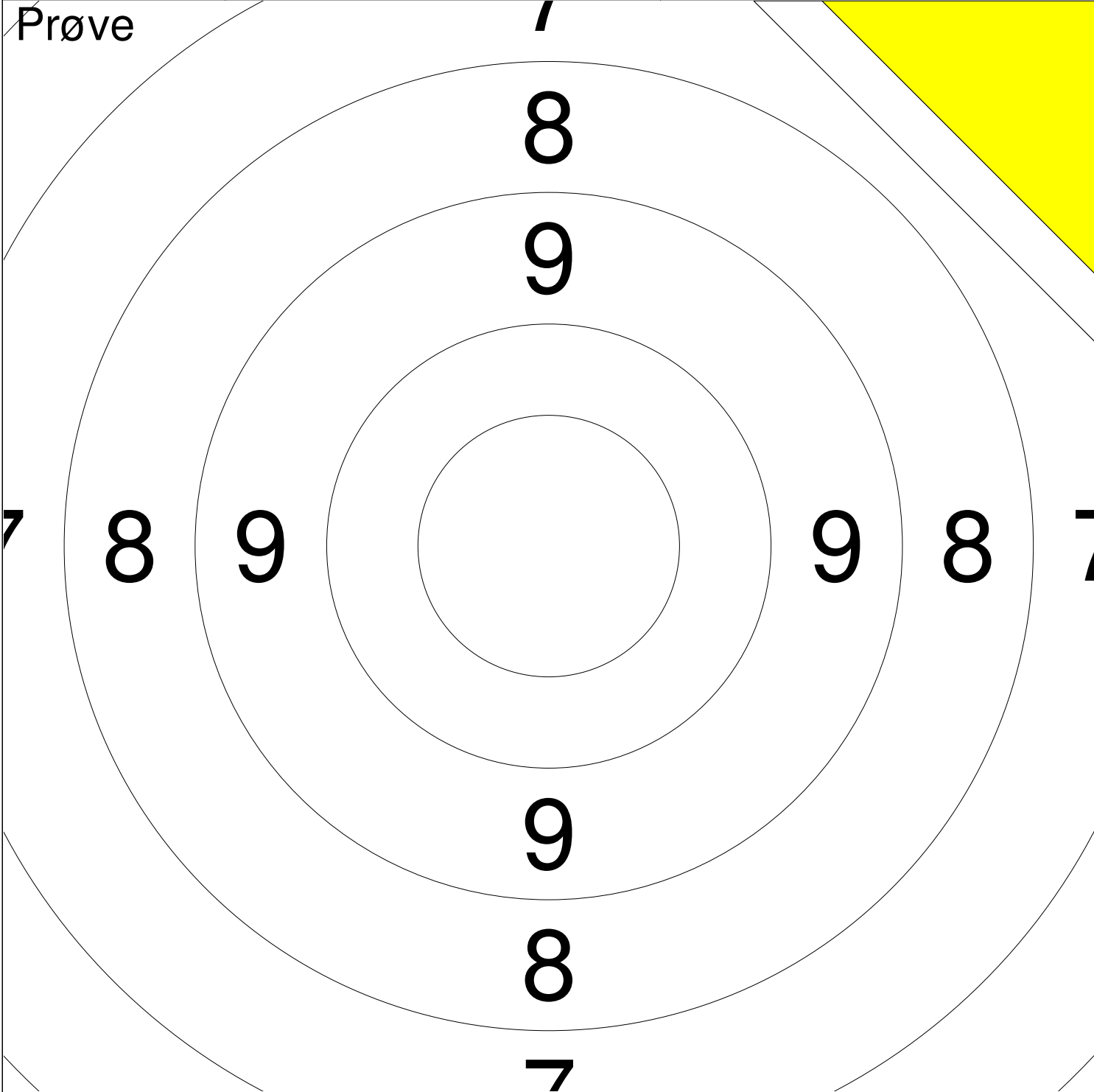

--

Serie	0
-------	---

Total	0
-------	---

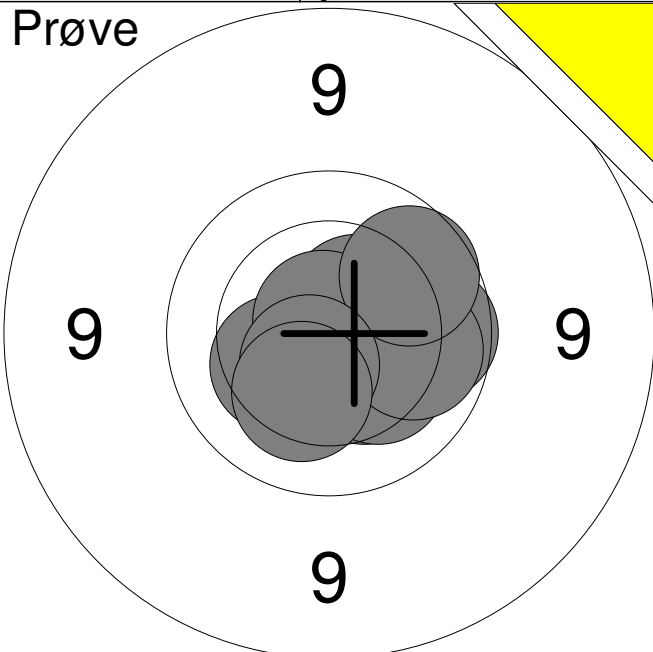
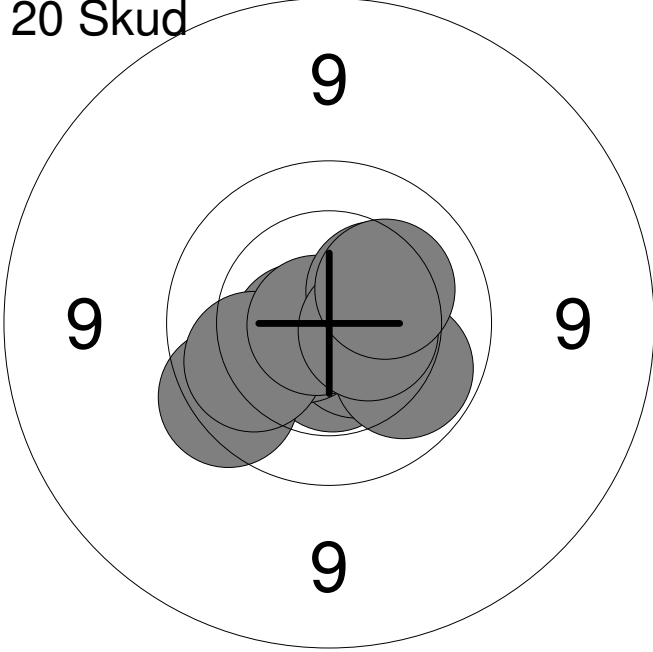
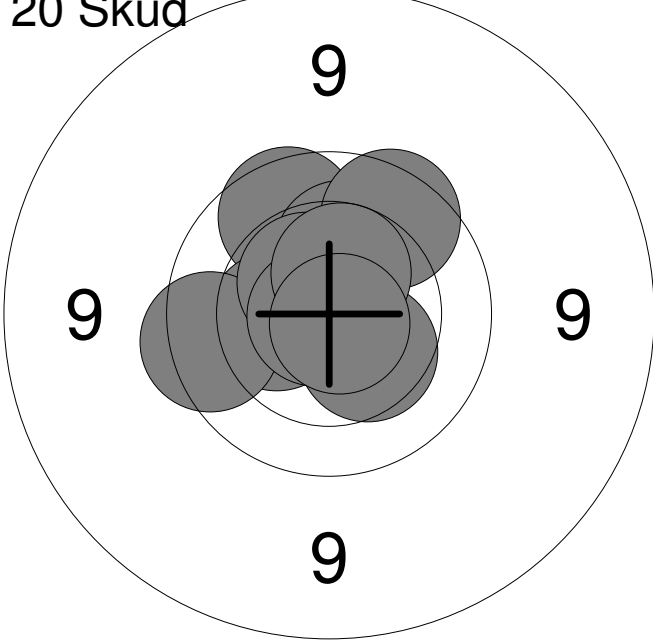
Hold	Skive	René Stricker Jensen	
29	6		
15m	Vodskov Skytteforening	ÅK2	
11.02.2015	Jyllandsstævne 2015	Aalborg Skyttekreds	
<b>Prøve</b> 	1:	9.9	→
	2:	10.3	↙
	3:	10.5x	↗
	4:	10.8x	↗
	5:	10.4	↘
	6:	10.3	↘
	7:	10.0	→
	8:	9.9	↗
	9:	10.5x	↘
	10:	10.3	↘
	<b>Serie</b>		<b>98.0</b>
<b>Total</b>		<b>0.0</b>	
<b>20 Skud</b> 	1:	10.5x	↓
	2:	9.8	↙
	3:	10.5x	↘
	4:	10.6x	↙
	5:	10.0	↙
	6:	10.0	↘
	7:	10.8x	↙
	8:	10.3	↗
	9:	10.5x	→
	10:	10.2	↗
	<b>Serie</b>		<b>99.0</b>
<b>Total</b>		<b>99.0</b>	
<b>20 Skud</b> 	11:	10.4	↘
	12:	9.9	↗
	13:	10.4	↙
	14:	10.2	↑
	15:	9.8	↙
	16:	9.8	↗
	17:	10.5x	↗
	18:	10.8x	↙
	19:	10.5	↗
	20:	10.8x	↘
	<b>Serie</b>		<b>97.0</b>
<b>Total</b>		<b>196.0</b>	

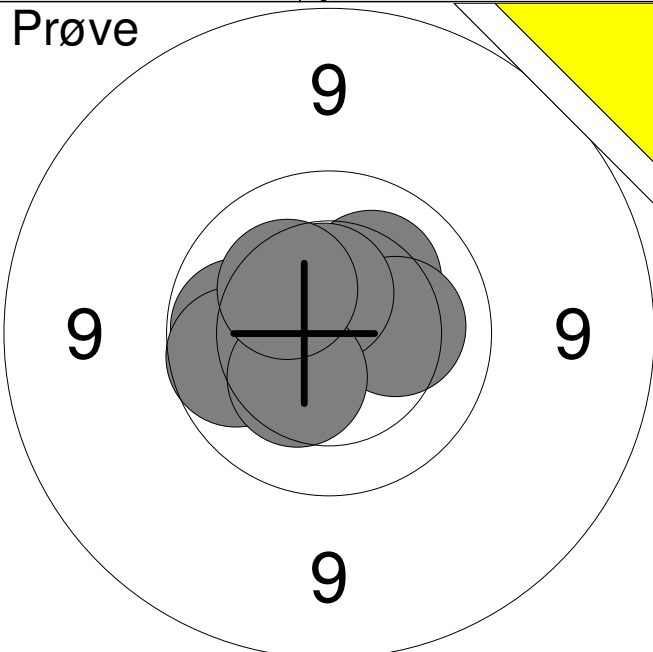
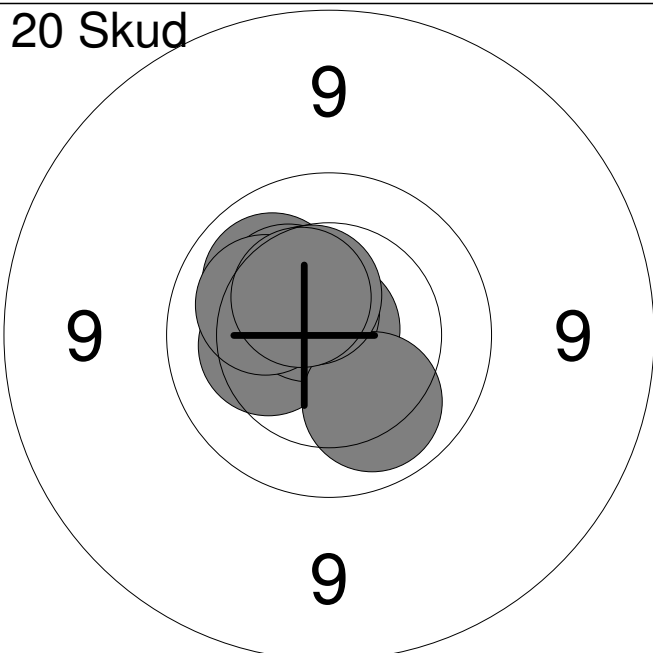
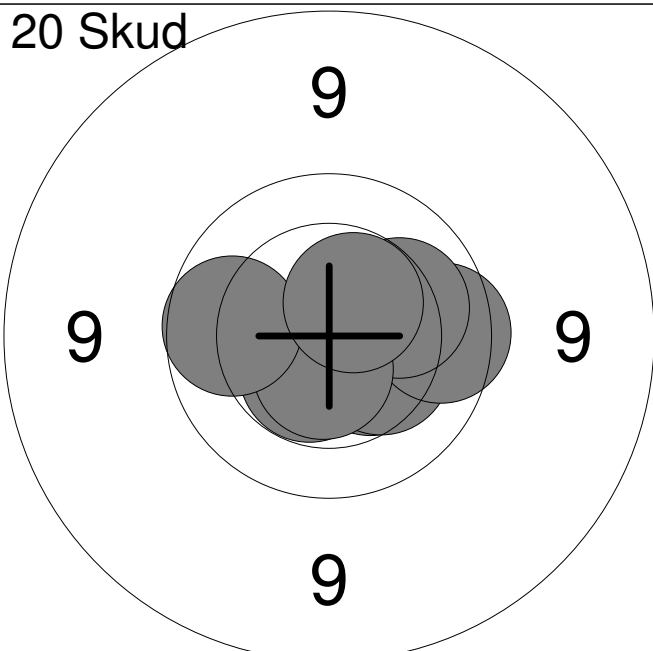
Hold	Skive	Jacob Schultz	
29	9		
15m	Aalborg Skyttekreds	MB1	
11.02.2015	Jyllandsstævne 2015	Aalborg Skyttekreds	
<b>Prøve</b> 	1:	10.2	↗
	2:	10.3	↖
	3:	10.2	→
	4:	10.5x	↑
	5:	10.0	↖
	6:	9.9	↖
	7:	10.4	↘
	8:	10.3	↗
	<b>Serie</b>		<b>79.0</b>
<b>Total</b>		<b>0.0</b>	
<b>20 Skud</b> 	1:	10.1	↗
	2:	10.3	↗
	3:	10.5x	↖
	4:	10.9x	↑
	5:	10.3	↖
	6:	10.6x	↗
	7:	10.2	↗
	8:	10.1	↘
	9:	10.5	↗
	10:	10.4	↗
<b>Serie</b>		<b>100.0</b>	
<b>Total</b>		<b>100.0</b>	
<b>20 Skud</b> 	11:	10.5x	↘
	12:	10.5	→
	13:	10.4	↘
	14:	10.3	↘
	15:	10.8x	↘
	16:	9.8	→
	17:	10.1	→
	18:	10.6x	↘
	19:	9.9	↖
	20:	10.5x	↗
	<b>Serie</b>		<b>98.0</b>
<b>Total</b>		<b>198.0</b>	

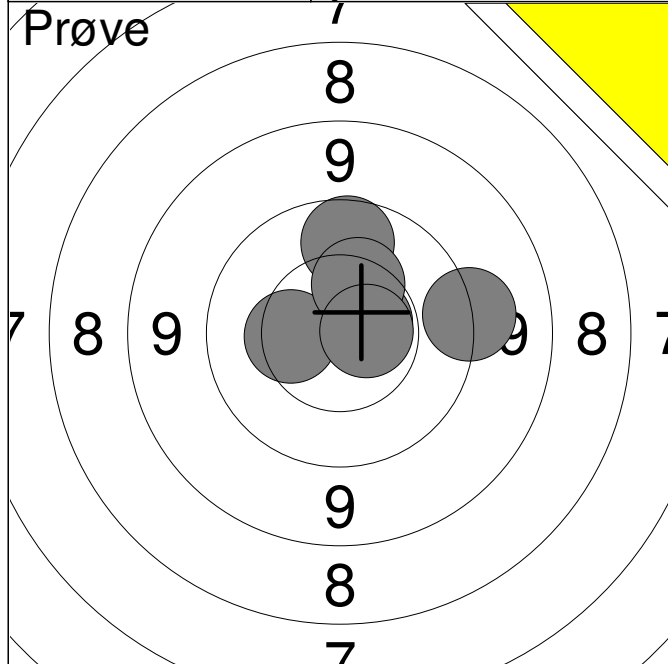

1:	9.4	→
2:	9.9	↑
3:	10.6x	→
4:	10.4	←
5:	10.3	↑
6:	10.6x	→
<b>Serie</b>		<b>58.0</b>
<b>Total</b>		<b>0.0</b>

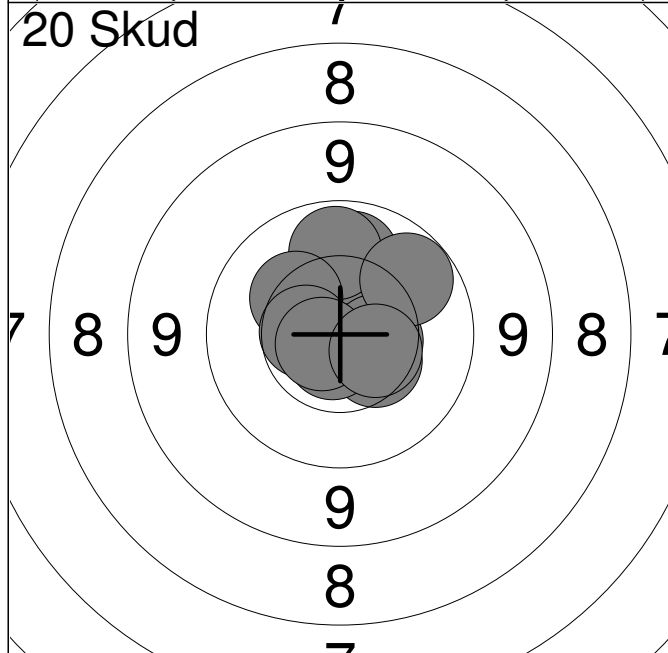

1:	10.1	↑
2:	10.0	↑
3:	10.5	→
4:	10.0	↗
5:	10.3	↗
6:	10.4	↘
7:	10.7x	↘
8:	10.6	←
9:	10.7x	↙
10:	10.5	→
<b>Serie</b>		<b>100.0</b>
<b>Total</b>		<b>100.0</b>

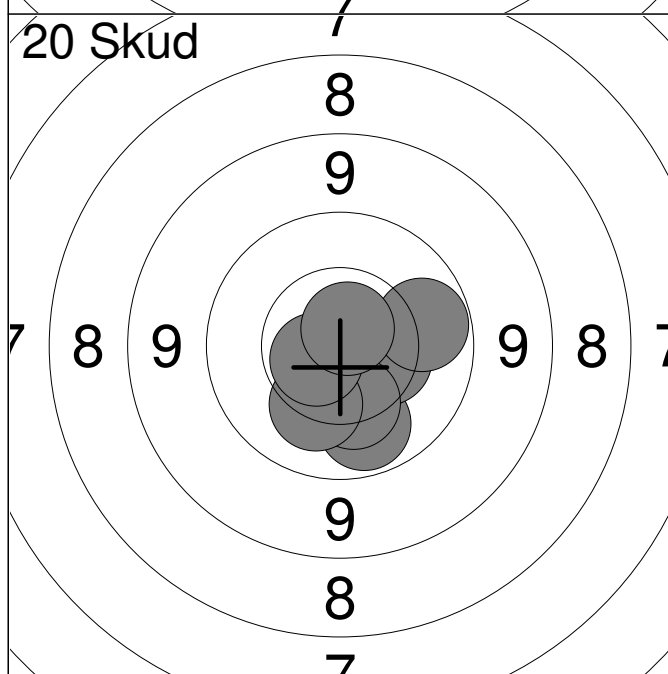

11:	10.7x	↙
12:	10.0	↙
13:	10.5	↙
14:	10.7x	↙
15:	10.4	→
16:	10.3	↘
17:	10.0	→
18:	10.2	↘
19:	10.6x	↙
20:	10.7x	↑
<b>Serie</b>		<b>100.0</b>
<b>Total</b>		<b>200.0</b>

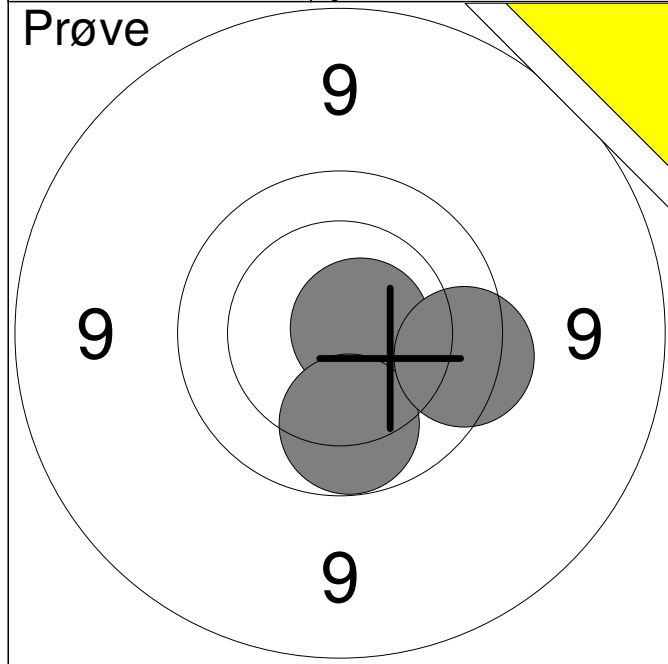

1:	10.7x	→
2:	10.0	↓
3:	9.7	→
<b>Serie</b>		<b>29.0</b>
<b>Total</b>		<b>0.0</b>

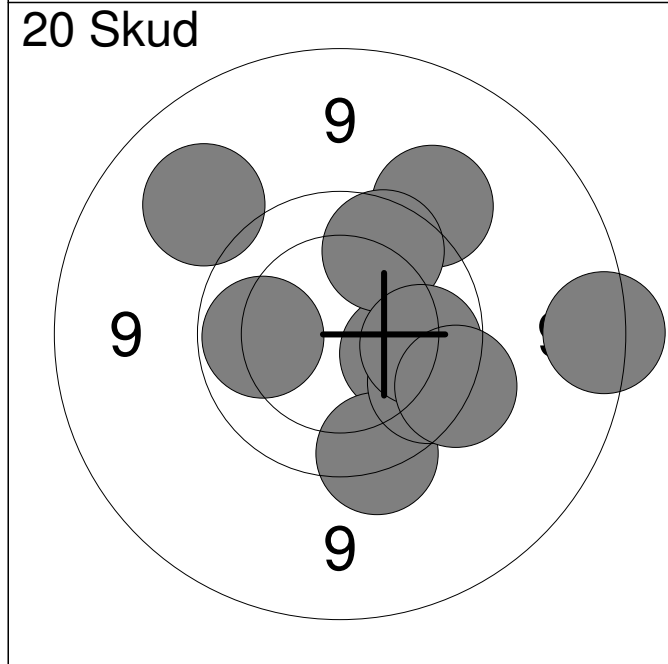

1:	10.2	→
2:	9.2	↗
3:	9.6	↓
4:	9.4	↗
5:	8.8	→
6:	10.0	←
7:	9.9	↗
8:	9.8	↓
9:	9.9	→
10:	9.6	↓
<b>Serie</b>		<b>91.0</b>
<b>Total</b>		<b>91.0</b>

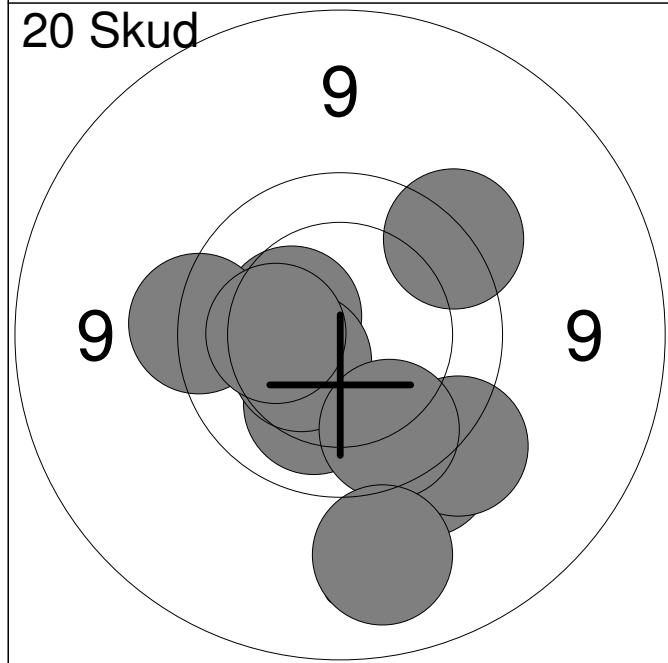

11:	10.2	↓
12:	10.4	↗
13:	10.4	←
14:	9.6	←
15:	9.6	↓
16:	9.5	↓
17:	9.6	↗
18:	9.9	↓
19:	9.1	↓
20:	10.3	←
<b>Serie</b>		<b>94.0</b>
<b>Total</b>		<b>185.0</b>



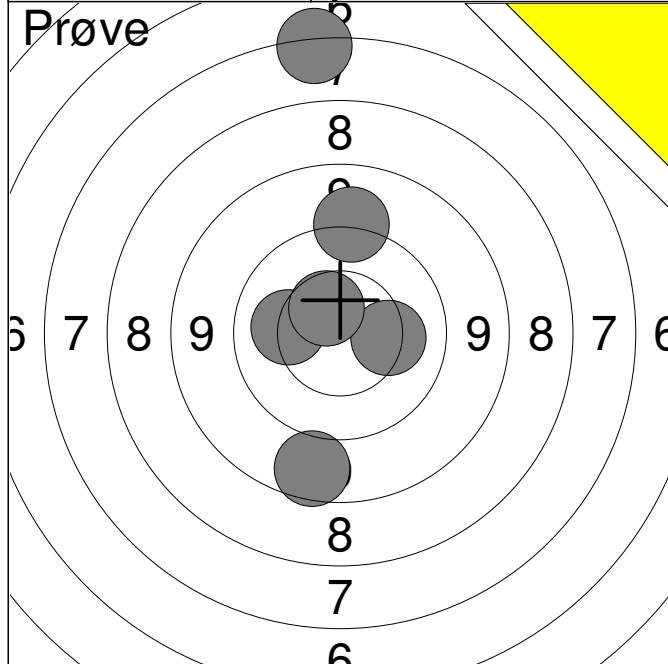

1:	6.5	↑
2:	8.8	↓
3:	10.2	←
4:	10.3	→
5:	9.3	↑
6:	10.5	↗
<b>Serie</b>		<b>53.0</b>
<b>Total</b>		<b>0.0</b>

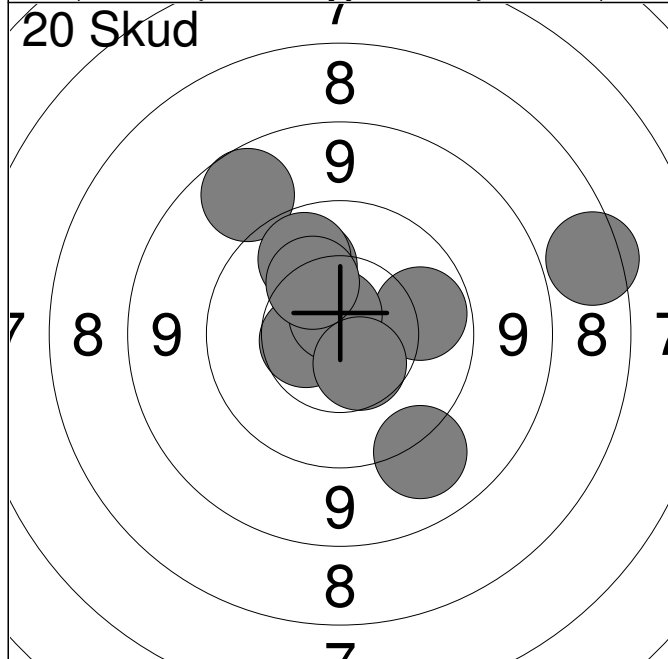

1:	10.0	→
2:	8.9	↗
3:	10.6	←
4:	9.2	↓
5:	10.7x	↑
6:	7.7	→
7:	10.1	↗
8:	10.5	↓
9:	10.0	↗
10:	10.3	↗
<b>Serie</b>		<b>94.0</b>
<b>Total</b>		<b>94.0</b>

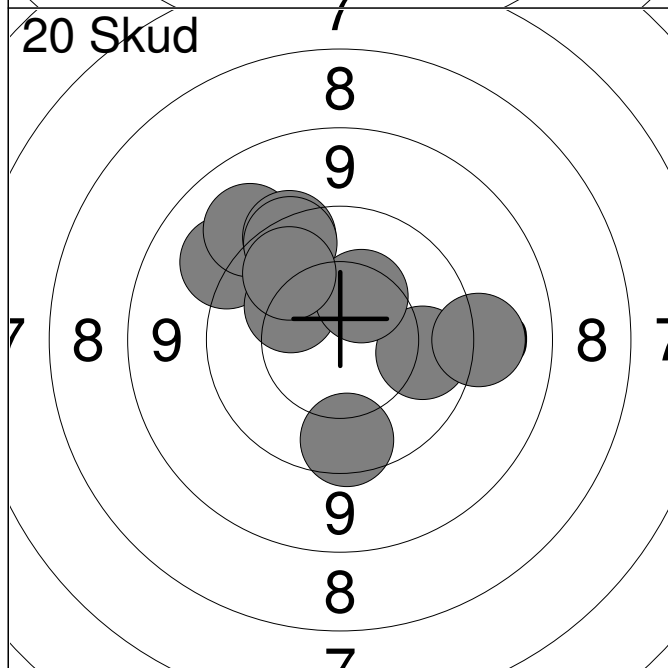

11:	9.3	↗
12:	10.3	↗
13:	9.2	↗
14:	9.6	↗
15:	9.7	↗
16:	10.0	→
17:	10.4	↗
18:	10.0	↗
19:	9.3	→
20:	9.8	↓
<b>Serie</b>		<b>94.0</b>
<b>Total</b>		<b>188.0</b>

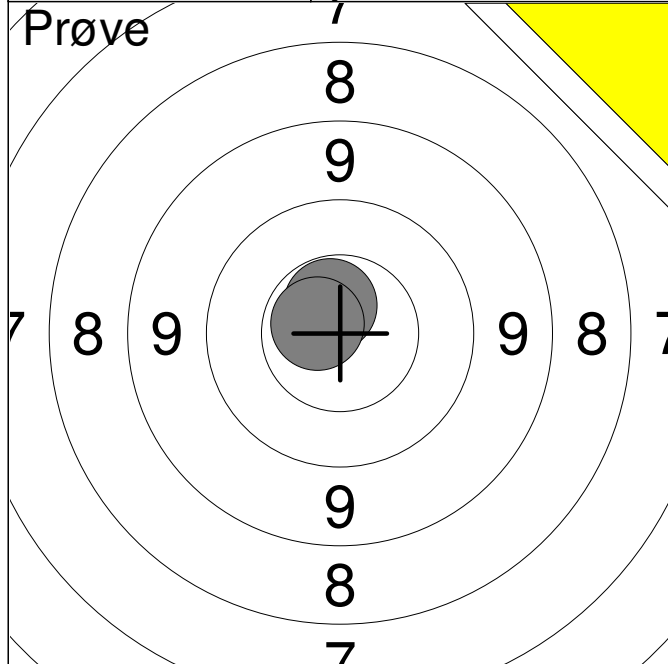

	1:	10.6x	↑
	2:	10.7x	↖
<b>Serie</b>			<b>20.0</b>
<b>Total</b>			<b>0.0</b>

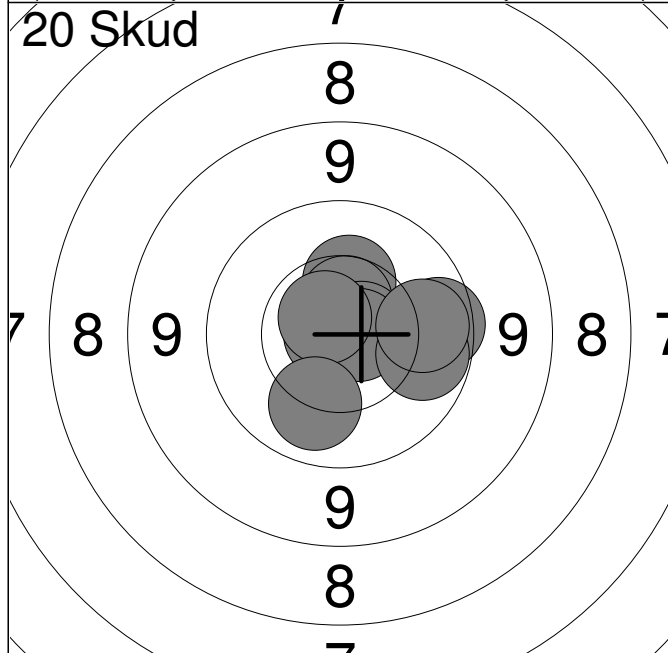

	1:	10.3	↑
	2:	10.6	↑
	3:	10.7x	→
	4:	10.8x	←
	5:	10.7x	→
	6:	10.7x	↗
	7:	9.8	→
	8:	10.0	→
	9:	10.0	→
	10:	10.1	↓
<b>Serie</b>			<b>99.0</b>
<b>Total</b>			<b>99.0</b>

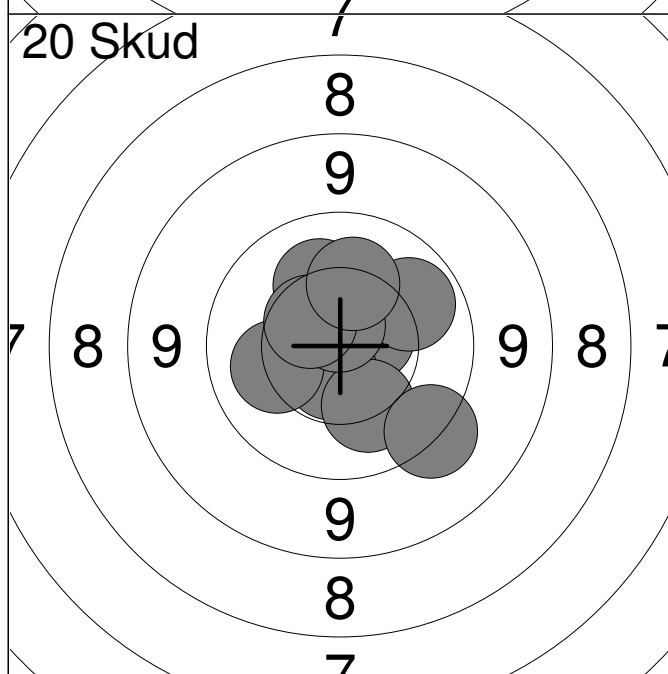

	11:	10.6x	→
	12:	10.2	↑
	13:	10.0	↗
	14:	10.6x	↓
	15:	10.2	←
	16:	10.2	↓
	17:	10.7x	↑
	18:	9.5	↘
	19:	10.5	↗
	20:	10.2	↑
<b>Serie</b>			<b>99.0</b>
<b>Total</b>			<b>198.0</b>

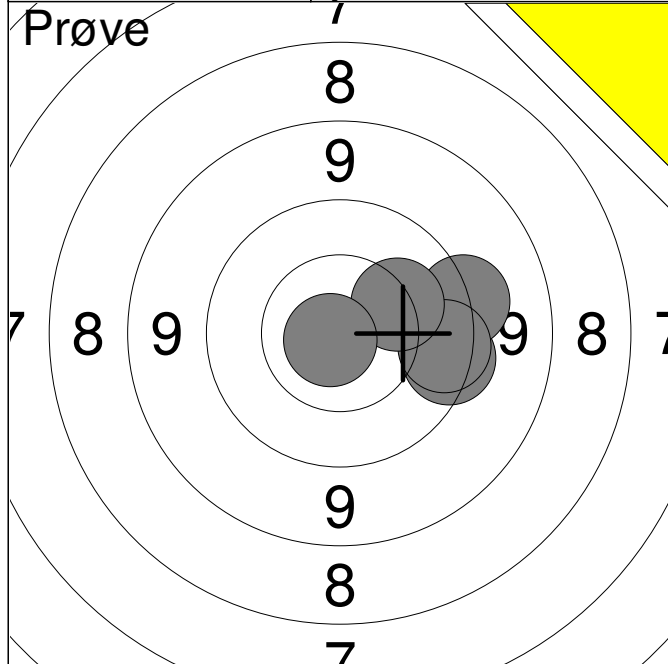

1:	9.6	→
2:	9.4	→
3:	9.7	→
4:	10.2	↗
5:	10.8x	↙
<b>Serie</b>		<b>47.0</b>
<b>Total</b>		<b>0.0</b>

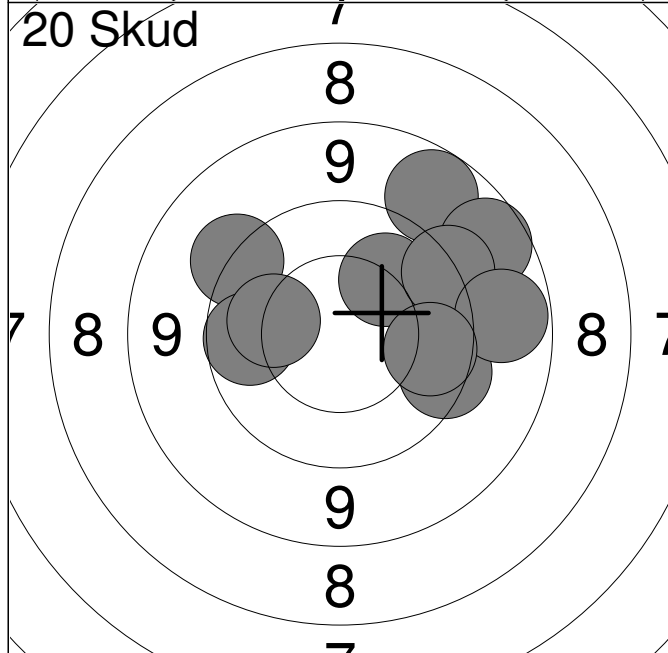

1:	9.0	↗
2:	8.9	↗
3:	10.1	↗
4:	9.5	↗
5:	9.6	→
6:	9.4	↗
7:	9.0	→
8:	9.9	←
9:	10.2	←
10:	9.9	→
<b>Serie</b>		<b>91.0</b>
<b>Total</b>		<b>91.0</b>

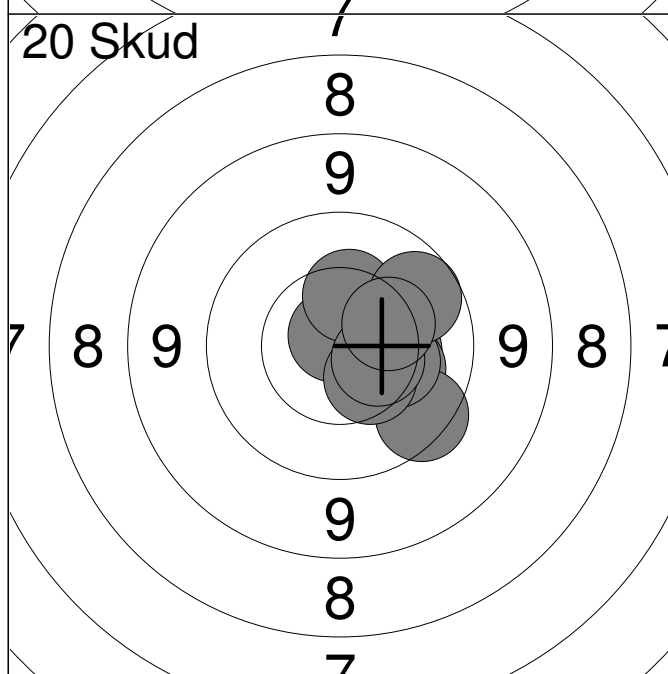

11:	10.3	→
12:	10.8x	↗
13:	10.2	↘
14:	9.7	↘
15:	10.3	→
16:	10.4	↗
17:	10.4	↘
18:	10.5	→
19:	9.9	↗
20:	10.3	→
<b>Serie</b>		<b>98.0</b>
<b>Total</b>		<b>189.0</b>

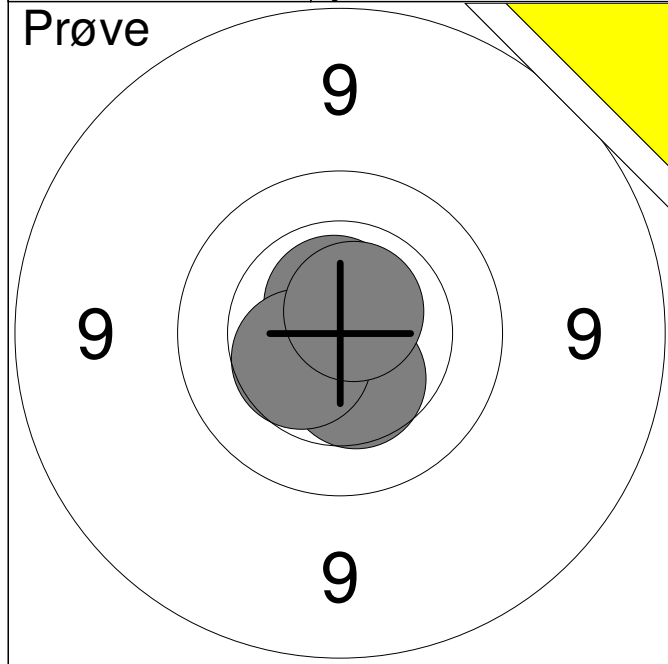

1:	10.6x	↑
2:	10.4	↓
3:	10.5	↙
4:	10.7x	↗
<b>Serie</b>		<b>40.0</b>
<b>Total</b>		<b>0.0</b>

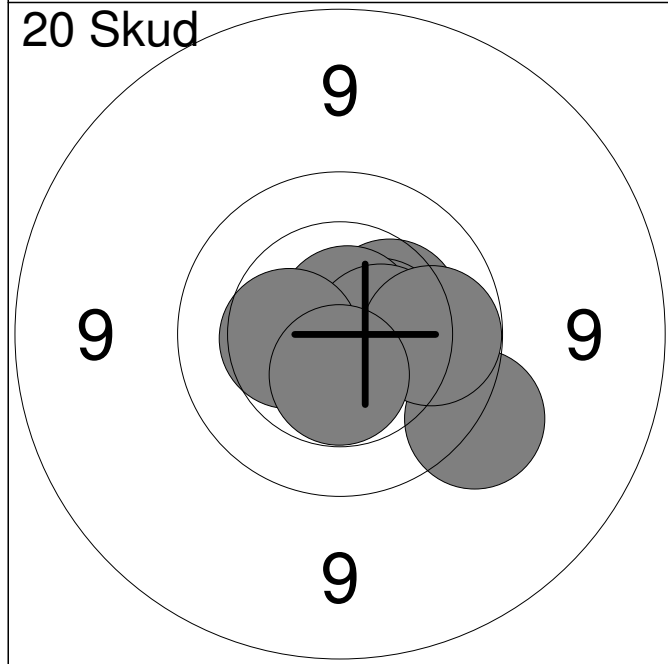

1:	10.7x	↓
2:	10.3	↗
3:	9.5	↘
4:	10.6x	←
5:	10.5x	→
6:	10.7x	↗
7:	10.5x	→
8:	10.4	←
9:	10.0	→
10:	10.5x	↓
<b>Serie</b>		<b>99.0</b>
<b>Total</b>		<b>99.0</b>

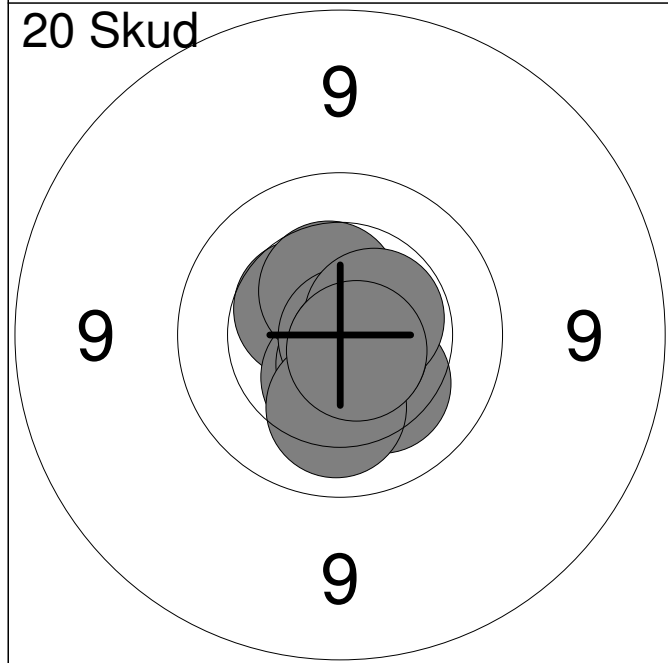

11:	10.5	↗
12:	10.5	↓
13:	10.5	↗
14:	10.6x	↓
15:	10.9x	↗
16:	10.3	↘
17:	10.7x	↘
18:	10.2	↓
19:	10.5x	↗
20:	10.7x	↘
<b>Serie</b>		<b>100.0</b>
<b>Total</b>		<b>199.0</b>

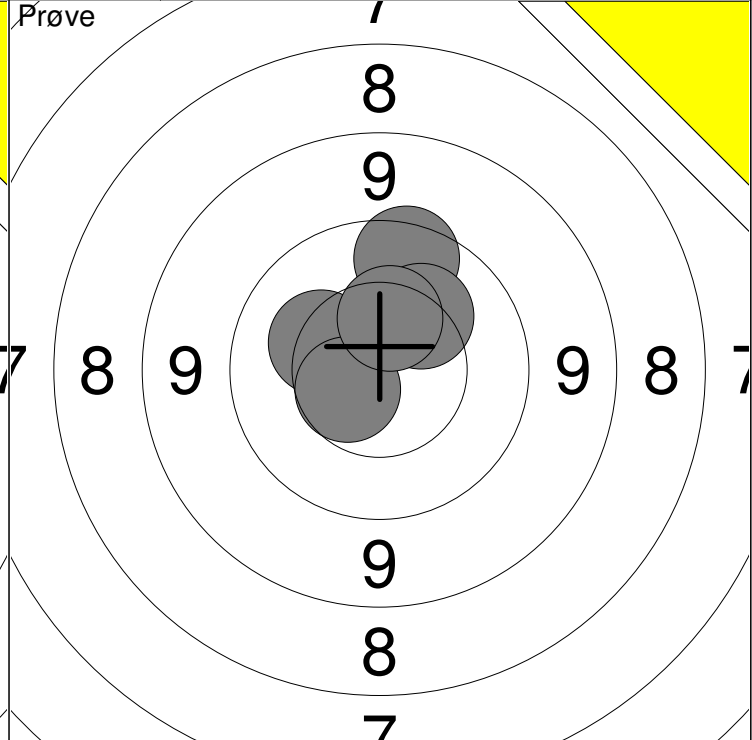
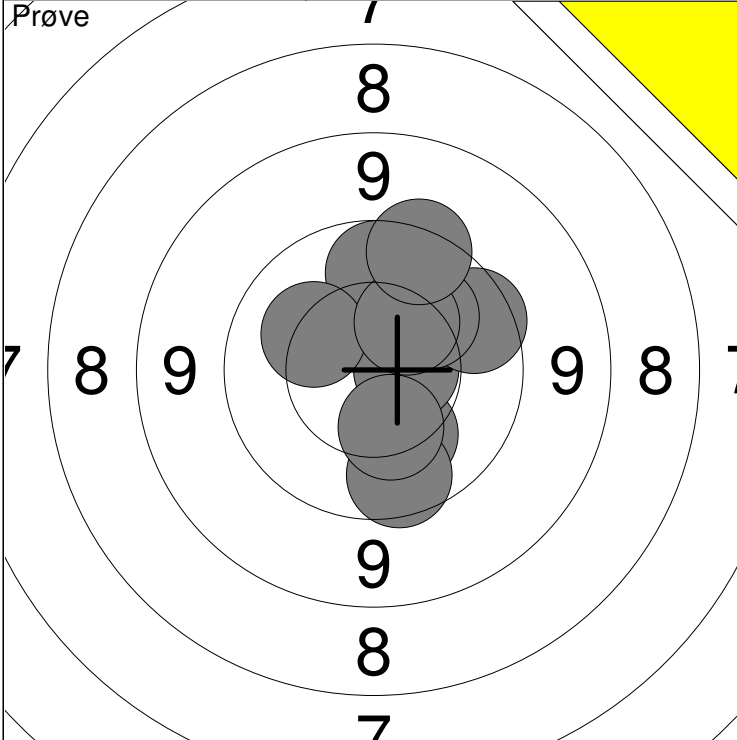

1: 10.2 ↘	6: 9.9 ↑	Serie	96
2: 10.6x →	7: 10.2 ↙		
3: 9.8 ↘	8: 10.2 ↗	Total	0
4: 10.3 ↘	9: 10.3 ↗		
5: 9.8 ↗	10: 9.6 ↑		

11: 10.3 ↖	Serie	49
12: 10.6 ↙		
13: 9.7 ↑	Total	0
14: 10.2 ↗		
15: 10.4 ↑		

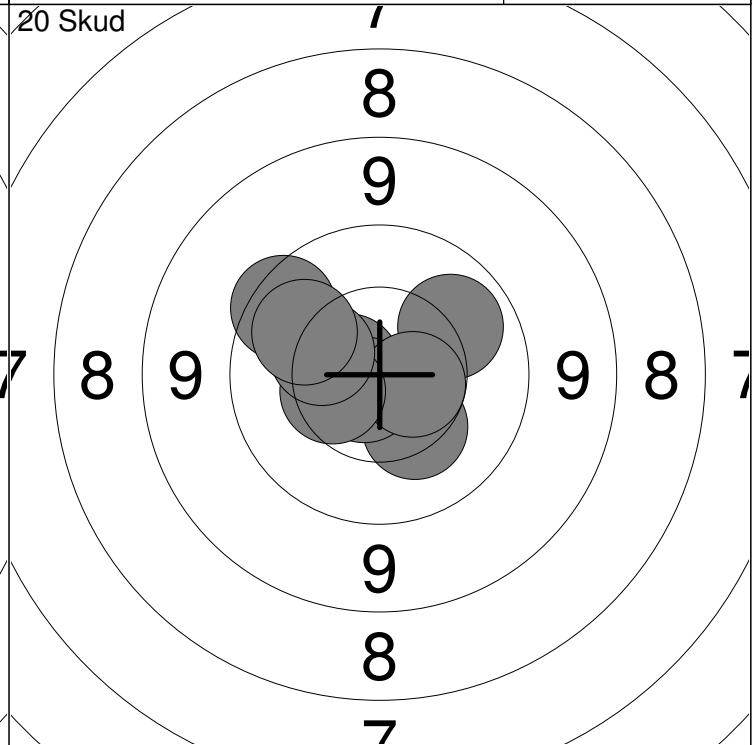
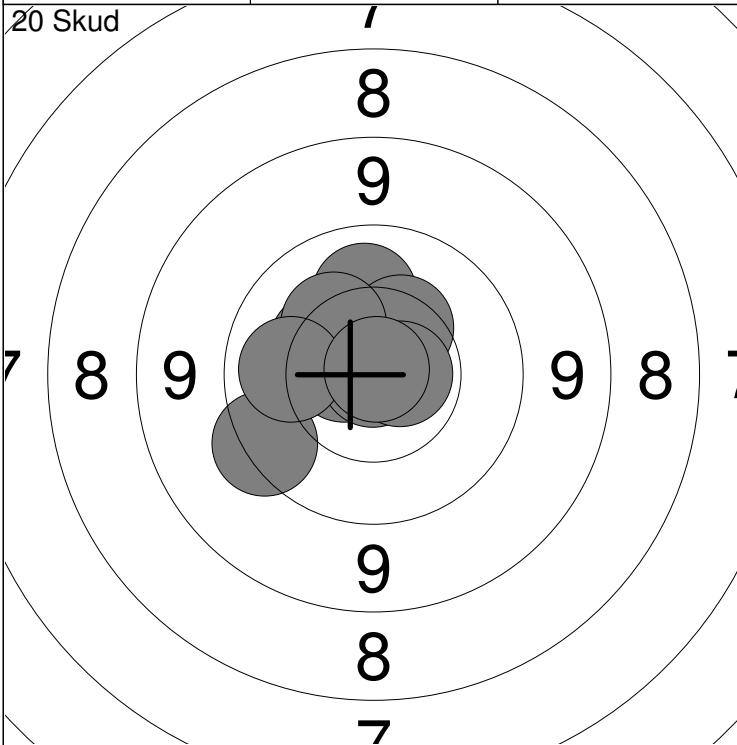

1: 10.6x ↖	6: 10.4 ↗	Serie	99
2: 10.9x ↖	7: 10.3 ↙		
3: 9.6 ↖	8: 10.7x →	Total	99
4: 10.1 ↑	9: 10.1 ↖		
5: 10.3 ↖	10: 10.9x ↗		

11: 10.1 ↗	16: 10.6x →	Serie	99
12: 10.7x ↖	17: 10.4 ↖		
13: 10.3 ↘	18: 9.7 ↙	Total	198
14: 10.6x ↖	19: 10.3 ↖		
15: 10.7x ↙	20: 10.1 ↖		